

AIRSTREAM®



SCAN ME
Live Riveted®

2025 CLASSIC

CLASSIC

Owner's Manual

User Guide Videos and Airstream Academy

Scan the QR code on the cover or visit <https://support.airstream.com> to view model-specific User Guide Videos that explore topics discussed in this manual. Visit Airstream Academy at <https://www.airstream.com/academy/> to learn the ins and outs of Airstreaming by exploring videos, articles, and frequently asked questions covering a wide range of popular RV topics.

Notice

All information, illustrations and specifications contained in this manual reflect the latest product information available as of the date of publication approval. Airstream reserves the right to change specifications, design and/or equipment after such date without obligation or notice.

AIRSTREAM®, the Airstream trade dress, and MYAIRSTREAM™ and all related model names, logos, slogans, and marks are trademarks of Thor Tech, Inc. All other trademarks contained in these materials are the property of their respective owners.

For information about open source software used in connection with your vehicle and related components, applications and services, see the Legal section of the [Airstream.com](https://www.airstream.com) website.

Do not copy, reproduce, publish, or otherwise distribute this manual without the express written permission of Airstream.

Airstream Classic Owner's Manual

©2025 Airstream, Inc. All rights reserved

Publication Date: January 2025

REV# 03

AIRSTREAM®

TABLE OF CONTENTS

INTRODUCTION	1-1	TOWING	7-1
SAFETY	2-1	Tow Vehicle	7-2
Safety Precautions	2-2	Brakes	7-2
Chemical Sensitivity and Ventilation	2-3	Loading	7-3
Alarms and Detectors	2-4	Hitching Up	7-4
GENERAL INFORMATION	3-1	Towing	7-5
Limited Warranty Policy	3-2	MAINTENANCE	8-1
Service	3-6	Maintenance Schedule	8-2
Camping	3-7	Suggested Maintenance and Replacement Parts	8-3
FLOOR PLANS AND SPECIFICATIONS	4-1	Tires	8-5
Floor Plans	4-2	Axles and Brakes	8-9
Specifications	4-4	Power Jack	8-11
INTERIOR	5-1	Water Pump	8-11
General Information and Cleaning	5-3	Drain and Waste System	8-14
Plumbing	5-6	Winterizing and Storage	8-16
Electrical System Overview	5-8	Heating and Hot Water System.	8-18
Electrical System Operation	5-12	Main Door Care.	8-19
Entertainment Systems.	5-21	Windows	8-19
Appliances	5-22	Electrical Diagrams	8-20
EXTERIOR	6-1	Fresh Water Layouts.	8-28
Cleaning	6-2	FAQs and Answers	8-31
General Information and Operation	6-3		

AIRSTREAM®

Section 1 INTRODUCTION

The Owner's Manual for your new Airstream trailer is designed to respond to the most frequent inquiries regarding the operation, function, and care of the many systems that make modern trailering a joy.

Airstream realizes our customers possess varying degrees of expertise in the area of maintaining and repairing the appliances in their trailer. For this reason, the service information found in this manual is directed toward those with average mechanical skills.

We also realize that you may be more familiar with one area than you are with another. Only you know your capabilities and limitations. We want you to use this manual and hope you will find the information contained in it useful. However, should you ever feel that you may be in need of assistance, please consult your Airstream dealer for advice on service that may be required.

A brief explanation of the operation of the appliances such as refrigerator, furnace, water heater, and others, are explained in this manual. However, you will also find the manufacturer's information, supplied in a packet included with this manual, to be more detailed.

All information, illustrations, and specifications contained in this manual are based on the latest product information available at the time of publication approval. If and when new materials and production techniques are developed that can improve the quality of its product, or material substitutions are necessary due to availability, Airstream reserves the right to make such changes.

Optional items may be available on all, or particular models. Additionally, some optional items can only be included during the manufacturing phase and cannot later be added to the trailer.

The inclusion of optional items information in this manual does not imply or suggest the availability, application, suitability, or inclusion for any specific unit.

Airstream uses the  safety alert symbol and signal words Danger, Warning, and Caution to alert you to potential personal injury hazards. Obey all safety messages that follow this symbol to avoid possible injury or death. The following are examples of each type of signal word, safety message, and information message found throughout this manual.

DANGER

Indicates a hazardous situation which, if not avoided, will result in death or serious injury.

WARNING

Indicates a hazardous situation which, if not avoided, could result in death or serious injury.

CAUTION

Indicates a hazardous situation which, if not avoided, could result in minor or moderate injury.

NOTICE

Indicates a potential situation which, if not avoided, may result in damage to your Airstream. Addresses practices not related to personal injury.

NOTE

Provides noteworthy information and tips about your Airstream.

AIRSTREAM®

Section 2 SAFETY

SAFETY PRECAUTIONS	2-2	ALARMS AND DETECTORS	2-4
Transporting of Passengers	2-2	Smoke Alarm.	2-4
Towing and Weight Distribution.	2-2	Liquid Propane Gas (LPG)/Carbon	
Controlling Sway	2-2	Monoxide (CO) Detector	2-4
Lug Nut Torquing	2-2	Low Voltage	2-5
Tire Safety	2-2	Detector Test	2-5
Appliances and Equipment	2-2	This Carbon Monoxide Detector Is Not	2-6
Mold	2-2	Important Safety Precautions.	2-6
CHEMICAL SENSITIVITY AND VENTILATION	2-3	What Is Carbon Monoxide	2-6
Chemical Sensitivity	2-3	Conditions that can result in potentially	
Formaldehyde	2-3	dangerous CO situations	2-6
Ventilation	2-3	Symptoms of Carbon Monoxide Poisoning	2-7
Do Not Smoke	2-3	Basic Rules For LPG Safety	2-7
Medical Advice	2-3	If You Smell Gas.	2-7
		Fire Extinguisher	2-8
		Safety	2-8

Safety Precautions

Many things can be construed as safety related, but the most important is your common sense. If you are careless with matches, cigarettes, flammable material, or any other hazardous material, you surely realize your potential for accidents is greatly increased.

You will find many safety recommendations in this section and throughout the manual. The following recommendations are the ones we consider to be the most important.

Transporting of Passengers

The transporting of people in the trailer puts their lives at risk and may be illegal. The trailer does not have seat belts, therefore, it is not designed to carry passengers.

⚠ WARNING

Never transport passengers inside a trailer. Towing a trailer with passengers inside is unsafe and could result in death or serious injury.

Towing and Weight Distribution

Weight distribution is an important factor when loading your travel trailer. A recreational vehicle with the cargo distributed properly will result in efficient, trouble-free towing; [see Loading on page 7-3](#).

Controlling Sway

Sway or fishtailing is the sideways action of a trailer caused by external forces. Excessive sway of your travel trailer can lead to the rollover of the trailer and tow vehicle, resulting in serious injury or death; [see Controlling Sway or Fishtailing on page 7-8](#).

Lug Nut Torquing

Making sure wheel mounting nuts (lug nuts) on trailer wheels are tight and properly torqued is an important responsibility that trailer owners and users need to understand and practice. Inadequate and/or inappropriate wheel nut torque (tightness) is a major cause of lug nuts loosening in service. Loose lug nuts can rapidly lead to a wheel separation, resulting in potentially serious safety consequences; [see Lug Nut Torquing on page 8-9](#)

⚠ WARNING

Use a torque wrench to tighten lug nuts. Tightening by hand or with an Impact wrench is not recommended. For lug nut torque values, [see Specifications on page 4-4](#)

Tire Safety

Properly maintained tires improve the steering, stopping, traction, and load-carrying capability of your vehicle; [see Tire Care on page 8-6](#). Also, be sure to read the Tire Safety Manual Addendum included with your owner's packet.

Appliances and Equipment

The appliances (stove) and equipment (hot water heater, furnace, etc.) typically operate on liquefied petroleum gas. LP gas is flammable and is contained under high pressure. Improper use may result in a fire and/or explosion. Make sure to follow all instructions and warnings in this manual as well as those in the specific owner's manuals of the appliances and equipment.

NOTE

For additional LPG warnings and safety information, [see Section 5 and Section 6](#).

Mold

Mold and mold spores exist throughout indoor and outdoor environments. There is no practical way to eliminate all mold and mold spores in the indoor environment; however, the way to control indoor mold growth is to control moisture; [see Inhibiting Mold Growth on page 3-10](#).

Chemical Sensitivity and Ventilation

Chemical Sensitivity

Immediately after the purchase of your new recreational vehicle, and sometimes, after it has been closed up for an extended period of time, you may notice a strong odor and/or experience a chemical sensitivity. This is not a defect in your recreational vehicle. Like your home, there are many different products used in the construction of recreational vehicles, such as carpet, linoleum, plywood, insulation, upholstery, etc. Formaldehyde is also the by-product of combustion and numerous household products, such as some paints, coatings, and cosmetics. However, recreational vehicles are much smaller than your home and therefore, the exchange of air inside a recreational vehicle is significantly less than in a home. These products, when new or when exposed to elevated temperatures and/or humidity, may off-gas different chemicals, including formaldehyde. This off-gassing, in combination with the minimal air exchange, may cause you to experience irritation of the eyes, nose, and throat, as well as sometimes headache, nausea, and a variety of asthma-like symptoms. Elderly persons and young children, as well as anyone with a history of asthma, allergies, or lung problems, may be more susceptible to the effects of off-gassing.

Formaldehyde

Formaldehyde is a naturally occurring substance and is an important chemical used widely by industries to manufacture building materials and numerous household products. It is also a by-product of combustion and certain other natural processes. Thus, it may be present inside the trailer with some individuals being sensitive to it. Ventilation of the unit normally reduces the exposure to a comfortable level.

Trace levels of formaldehyde are released from smoking; cooking; use of soaps and detergents, such as carpet shampoos, cosmetics; and many other household products. Some people are very sensitive to formaldehyde while others may not have any reaction to the same levels of formaldehyde. Amounts released decrease over time.

Your Airstream trailer was manufactured using low formaldehyde-emitting (LFE) wood products, use of which is typical in the recreation vehicle industry. Formaldehyde has an important role in the adhesives used to bind wood products used in recreation vehicles. The wood products in your trailer are designed to emit formaldehyde at or lower than industry guidelines and should not produce symptoms in most individuals.

While LFE wood products typically do not emit formaldehyde at a level that would cause symptoms in most individuals, it is possible, though not likely, for that to occur when the trailer is not properly ventilated. Ventilation is an essential requirement for trailer use, for many reasons. Any effects of formaldehyde can be greatly reduced by actions such as opening windows, opening roof vents, running the air conditioner, or some combination thereof. In addition, the emission of formaldehyde by these products naturally decreases rapidly over time.

Airstream strongly suggests that you take measures to properly ventilate your trailer on a regular basis. If you have any questions with respect to proper ventilation of your trailer, please do not hesitate to contact your dealer or Airstream.

Ventilation

To reduce or lessen exposure to chemicals from off-gassing, it is of utmost importance that you ventilate your recreational vehicle. Ventilation should occur frequently after purchase and at times when the temperatures and humidity are elevated. Remember, off-gassing is accelerated by heat and humidity. Open windows, exhaust vents, and doors. Operate ceiling and/or other fans, roof air conditioners, and furnaces. Use a fan to force stale air out and bring fresh air in. Decreasing the flow of air by sealing the recreational vehicle increases the formaldehyde level in the vehicle's indoor air.

Do Not Smoke

It is recommended you do not smoke inside your recreational vehicle. In addition to causing damage to your recreational vehicle, tobacco smoke releases formaldehyde and other toxic chemicals.

Medical Advice

Questions regarding the effects of formaldehyde on your health should be submitted to your doctor or local health department.

Alarms and Detectors

Smoke Alarm

A smoke alarm is provided with your trailer. A manual pertaining to the alarm is included in the paperwork given to you at the dealership. Please read and follow all care, maintenance, and safety information contained in the smoke alarm manual.

The smoke alarm will beep once a minute for at least 30 days when the battery is weak. The battery must immediately be replaced with a fresh one.

⚠ WARNING

Alarm battery is shipped deactivated. Check your alarm for proper battery installation. To activate battery, new Airstream owner's must install included battery to proper orientation.

⚠ WARNING

Smoke alarms have a limited life. The unit should be replaced immediately if it is not operating properly. You should always replace a smoke alarm after 10 years from the date of purchase. Write the purchase date on the space provided on the back of unit.

If service is required or you have not received a smoke alarm user's manual, please contact the manufacturer, your dealer, or Airstream Customer Service.

Liquid Propane Gas (LPG)/Carbon Monoxide (CO) Detector



This detector has a five-year life; see end-of-life notification in the detectors manual. Please read the entire detector manual before operating the unit.

⚠ WARNING

Activation of your Carbon Monoxide alarm's audible horn indicates the presence of Carbon Monoxide that can kill you. Leave the area immediately!

⚠ WARNING

Failure to replace this product by the "REPLACE BY DATE" printed on the alarm may result in death by Carbon Monoxide poisoning. Replace By Date is five (5) years from the date of manufacture.

The LPG/CO detector is located in the galley area. LPG is a mixture of gases produced and sold commercially as a fuel for heating and cooking appliances. LPG is highly flammable and, as a result, can be explosive if ignited under certain circumstances. LPG is heavier than air and, if confined in a closed space, will accumulate close to the floor. The LPG/CO detector is designed to alarm when propane gas exceeds 10% of the lower-explosive-limit for more than 30 seconds or if CO gas reaches unsafe levels. When propane gas is detected the horn will sound with constant beeps and the red LED will be on. If CO gas is detected the horn will sound with 4 rapid chirps followed by a 4 second pause and the red LED will flash rapidly.

Your LPG/CO detector is wired directly to your trailer battery and incorporates a 1-amp, in-line fuse. It has no internal battery backup. In normal stand-by mode, the LED indicator will be green.

Low Voltage

The operating voltage for the detector is 12 VDC. The actual voltage supplied to the detector in a recreational vehicle may drop below the minimum 8 VDC. The detector provides the user with a low voltage warning before reaching that level and will provide additional distinct, clear warnings and alarms after the 8 VDC level is reached. However, if available power supplied to the unit is below the operating voltage of 8 VDC, the detector will not detect gas or provide protection against dangerous levels of LPG.

⚠ WARNING

If the low voltage warning sounds, the detector will need to be reset by disconnecting the battery, before normal operation will occur.

Detector Test

If the Silence/Test button is pressed while in normal operation, the alarm will perform a self test of the CO sensor, propane sensor and battery voltage. It is recommended to perform a self test weekly, after power up from storage, and before each trip. If the self test passes, the alarm will perform 2 cycles of the CO horn pattern (4 rapid chirps followed by a 4 second pause), followed by 2 cycles of the propane horn pattern (constantly beeping).

⚠ WARNING

Activation of this detector indicates the possible presence of LPG, which can cause an explosion and/or fire, causing serious injury or death. This normally indicates a leak in the LPG installation or an LPG appliance. Extinguish all open flames, open your windows and door, and evacuate the unit immediately. Do not activate any electrical switch. Turn off the LPG at your gas tank(s).

Do not re-enter your trailer until a qualified repair technician has corrected the problem and certified the system as safe.

⚠ WARNING

Have a qualified technician check your LPG system annually or if you detect any signs of leaks or malfunctions.

NOTE

For additional LPG warnings and safety information, see [Section 5](#) and [Section 6](#).

⚠ WARNING

Airstream recommends shutting off the gas supply at the LPG tanks before refueling the tow vehicle or entering a refueling station.

⚠ WARNING

This product is intended for use in ordinary, indoor locations of family living units. It is not designed to measure compliance with occupational safety and health administration (OSHA) commercial or industrial standards. Individuals who are at special risk from Carbon Monoxide exposure by reason of age, pregnancy, or medical condition may consider using warning devices which provide audible and visual signals for Carbon Monoxide concentration under 30 ppm. If in doubt, consult your medical practitioner.

NOTICE

It is not recommended that the detector be disconnected from the battery during periods of storage. There is a small heater on the sensor of the device that burns away impurities in the air during periods of normal use. During periods when power is interrupted, impurities can build up on the sensor. When power is returned to the detector, the detector alarm may activate until the impurities are burned off. This could take a number of hours, during which time the alarm will be constantly on.

This Carbon Monoxide Detector Is Not

- Designed to detect smoke, fire, or any gas other than Carbon Monoxide.
- To be seen as a substitute for the proper servicing of fuel-burning appliances.
- To be used on an intermittent basis, or as a portable alarm for spillage of combustion products from fuel-burning appliances.

⚠ WARNING

This Carbon Monoxide detector is designed for indoor use only. Do not expose to rain or moisture. Do not knock or drop the alarm. Do not open or tamper with the alarm as this could cause malfunction. The detector will not protect against the risk of Carbon Monoxide poisoning when the batteries are dead or missing. The alarm will only indicate the presence of CO gas at the sensor.

Important Safety Precautions

- Carbon Monoxide is produced by the incomplete combustion of fuels such as wood, charcoal, coal, heating oil, paraffin, gasoline, natural gas, propane, butane, etc.
- Ideally, it is recommended that a Carbon Monoxide detector should be installed in or near every room that has a fuel burning appliance such as any room heaters, water heaters, cookers, grills, etc.
- Ensure that the alarm horn can be heard by all those who are intended to hear it. Seek medical help if it is suspected that a user of the RV is suffering from Carbon Monoxide poisoning.
- If the alarm sounds, make sure to investigate the problem. Ignoring the alarm may result in sickness, injury or death. (CO may be present even if nothing is seen or smelled by the user.)
- Room spaces should be well ventilated when household cleaning supplies are used as these may cause a false alarm.
- Alarm should be tested once per week. If further details are required, which do not appear in this manual, contact the manufacturer.

What Is Carbon Monoxide

Carbon Monoxide (CO) is a highly poisonous gas that is released when fuels are burned. It is invisible, has no smell, and is therefore very difficult to detect with the human senses. Under normal conditions, in a room where fuel-burning appliances are well maintained and correctly ventilated, the amount of CO released into the room by appliances is not dangerous.

These fuels include wood, coal, charcoal, oil, natural gas, gasoline, kerosene, and propane. Common appliances are often sources of CO. If they are not properly maintained, are improperly ventilated, or malfunction, CO levels can rise quickly. CO is a real danger in air-tight trailers with added insulation, sealed windows, and other weatherproofing that can trap CO inside.

Conditions that can result in potentially dangerous CO situations

1. Excessive spillage or reverse-venting of fuel-burning appliances caused by outdoor conditions, such as:
 - Wind direction and/or velocity, including high gusts of wind. Heavy air in the vent pipes (cold/humid air with extended periods between cycles).
 - Negative pressure differential resulting from use of exhaust fans.
 - Simultaneous operation of several fuel-burning appliances competing for limited internal air.
 - Vent-pipe connections vibrating loose from clothes dryers, furnaces, or water heaters.
 - Obstructions in or unconventional vent-pipe designs which can amplify the above situations.
2. Extended use of un-vented fuel burning devices.
3. Temperature increase that can trap exhaust gases near the ground.

Symptoms of Carbon Monoxide Poisoning

- Mild Exposure - Slight headache, nausea, vomiting, fatigue (flu-like symptoms).
- Medium Exposure - Throbbing headache, drowsiness, confusion, fast heart rate.
- Extreme Exposure - Convulsions, unconsciousness, heart and lung failure. Exposure to carbon monoxide can cause brain damage and/or death.

⚠ DANGER

Many causes of reported **CARBON MONOXIDE POISONING** indicate that while victims are aware that they are not well, they become so disoriented that they are unable to save themselves by either exiting the area or calling for assistance. Also young children and pets may be the first to be affected.

⚠ WARNING

Test units used in RVs after the vehicle has been in storage, before each trip, and once a week while in use. Failure to test units used in RV's as described may remove your protection.

Basic Rules For LPG Safety

A warning label is displayed in the cooking area reminding you to provide an adequate supply of fresh air for combustion. The amount of oxygen supply in a trailer is limited due to its compact design. When using the cooking appliances, proper ventilation will prevent dangers of asphyxiation. It is especially important that cooking appliances not be used for comfort heating as the danger of asphyxiation is greater when the appliance is used for long periods of time.

⚠ DANGER

Do not use cooking appliances for comfort heating. Cooking appliances need fresh air for safe operation. Before operation, open an overhead vent or turn on an exhaust fan and open a window.

⚠ DANGER

A warning label has been located near the LPG container. This label reads: **DO NOT FILL CONTAINER(S) TO MORE THAN 80 PERCENT OF CAPACITY. Overfilling the LPG container can result in uncontrolled gas flow, which can cause fire or explosion. A properly filled container will contain approximately 80 percent of its volume as liquid LP gas.**

⚠ DANGER

Do not store LPG tanks within a vehicle. LPG tanks are equipped with safety devices that vent gas should the pressure become excessive.

⚠ DANGER

Portable fuel burning equipment, including wood and charcoal grills and stoves, shall not be used inside the recreational vehicle. The use of this equipment inside the recreational vehicle may cause fires or asphyxiation.

⚠ DANGER

Do not bring or store LPG tanks, gasoline, or other flammable liquids inside the vehicle because a fire or explosion may result.

Twice a year, or after a long storage period, we suggest you take your trailer in for a checkup and cleaning of the gas-operated appliances.

If You Smell Gas

1. Extinguish any open flames, pilot lights, and all smoking materials.
2. Do not touch electrical switches.
3. Shut off the gas supply at the tank valve(s) or gas supply connection.
4. Open doors and other ventilating openings.
5. Leave the area until odor clears.
6. Have the gas system checked and leakage source corrected before using again

Fire Extinguisher



The fire extinguisher should be checked for charge on a regular basis. Make sure your family knows how to release the extinguisher storage bracket and how to properly operate the extinguisher. Check with your local fire department for professional advice on its operation and use if you find the directions on the extinguisher unclear. They will be able and willing to assist you and your family.

Safety

As always, safety should be a top priority. Ensure you and everyone traveling with you can operate the main door and emergency exit window rapidly, without light. Contemplate other means of escape in case the designated exits are blocked.

The escape windows(s) are identified by their red release handles. Lift up on both latches to release the escape window. Push on the glass and it will swing clear.

⚠ WARNING

The window operation should be checked before each trip and the latches lubricated with silicon spray or an equivalent lubricant every 3 months.

⚠ WARNING

Read the directions on the fire extinguisher carefully. If you have any doubts as to its operation, you and your family should practice, and then replace or recharge the extinguisher. Your local fire department will be able to assist you and answer any questions.

AIRSTREAM®

Section 3 GENERAL INFORMATION

LIMITED WARRANTY POLICY	3-2	CAMPING	3-7
This Limited Warranty Covers	3-2	Suggested Pre-Travel Check List	3-7
Coverage Ends	3-2	Interior	3-7
Limitation Of Implied Warranties	3-2	Exterior	3-7
Disclaimer Of Incidental And Consequential Damages	3-2	Trailer Equipment and Accessories	3-7
Repair Remedy	3-2	Motoring Essentials	3-7
Back-Up Remedy	3-2	Overnight Stop	3-8
What Is Not Covered	3-3	Extended Stay	3-8
Obtaining Warranty Service	3-4	Leveling	3-8
Events That Discharge Airstream's Obligations Under This Limited Warranty	3-4	Stabilizing Jacks	3-9
Legal Remedies	3-4	Effects Of Prolonged Occupancy	3-9
Airstream Limited Warranty Excludes	3-5	Tips To Control Condensation	3-9
Normal Wear	3-5	Molds	3-9
Accident	3-5	Contributing Factors To Mold Growth	3-9
Abuse	3-5	Inhibiting Mold Growth	3-10
Chemical Gassing	3-5	Wastewater System	3-10
Exposure	3-5	Things Not To Put Into Toilet Or Drains	3-10
Overload	3-5	Winter Traveling	3-11
SERVICE	3-6	Tank Heaters	3-11
Coach-Net® Roadside Assistance	3-6		
Service Centers	3-6		
Reporting Safety Defects	3-6		

Limited Warranty Policy

This Limited Warranty Covers

(i) The first retail owner and any subsequent owners
(ii) ONLY those portions of a NEW travel trailer not excluded under the section “What is Not Covered,” when sold by an authorized dealership and used for its intended purpose of recreational travel and camping; and, (iii) ONLY defects in workmanship performed and/or materials used to assemble those portions of your travel trailer not excluded under the section “What is Not Covered.” “Defect” means the failure of the workmanship performed and/or materials used to conform with the design and manufacturing specification and tolerances of Airstream. This Limited Warranty is transferable, and the subsequent owner’s warranty coverage period shall be the unexpired balance of the original warranty coverage period. A completed copy of the Warranty Transfer Form must be submitted to Airstream at the time of resale.

When you request and accept the performance of warranty repairs under the terms of this Limited Warranty, you are accepting all terms of this Limited Warranty, including by way of example, warranty limitations and disclaimers, the forum selection clause and the clause reducing the time period when suit must be filed for breach.

If any term or condition in this limited warranty conflicts with your state’s Uniform Commercial Code (“UCC”) as interpreted by courts within your state, the provisions of your state’s UCC are varied as allowed for by USS 1-302.

Coverage Ends

36 months after the first retail owner first takes delivery of the travel trailer from an authorized dealership. Any action for breach of this warranty or any implied warranties must be commenced not more than 37 months after you first take delivery. Some states do not allow the reduction of the time when a breach of warranty claim must be commenced, so the reduction in time when a breach of warranty claim must be commenced may not apply to you.

Limitation Of Implied Warranties

Implied warranties arising under applicable law, if any, including but not limited to implied warranties of merchantability or fitness for a particular purpose, are hereby limited in duration to the term of this limited warranty and are limited in scope of coverage to those portions of the travel trailer covered by this limited warranty. There are no express warranties or any

implied warranties of merchantability on those portions of the travel trailer excluded from coverage. There is no warranty of any nature made by Airstream beyond that contained in this limited warranty. No person has authority to enlarge, amend, or modify this limited warranty. The dealer is not Airstream’s agent. Airstream is not responsible for any undertaking, representation, or warranty made by any dealer or others beyond those expressly set forth within this limited warranty. Some states do not allow limitations on how long an implied warranty lasts, so the above limitations may not apply to you.

Disclaimer Of Incidental And Consequential Damages

Airstream disclaims any and all incidental and consequential damages, including but not limited to expenses such as transportation to and from dealerships and Airstream repair facilities, loss of time, loss of pay, loss of use, inconvenience, commercial loss (including but not limited to lost profits), towing charges, bus fares, vehicle rental, service call charges, gasoline expenses, incidental charges such as telephone calls and facsimile transmissions, and expenses for lodging and moisture damage such as mold and mildew as well as rust and corrosion. This disclaimer is independent of any failure of the essential purpose of any warranties provided with the travel trailer and shall survive any determination that a warranty failed of its essential purpose. Some states do not allow the exclusion or limitation of incidental or consequential damages, so the above limitation or exclusion may not apply to you.

Repair Remedy

Airstream’s sole and exclusive obligation is to repair any covered defects discovered within the warranty coverage period if: (1) within 10 days of your discovery of a defect, you notify Airstream OR an authorized dealership of the defect; AND (2) you deliver your travel trailer to Airstream OR an authorized dealership at your cost and expense.

Back-Up Remedy

If the primary repair remedy fails to successfully cure any defect after a reasonable number of repair attempts, your sole and exclusive remedy shall be to have Airstream pay an independent service shop of your choice to perform repairs to the defect, which requires the exercise of good faith. If you select an independent service shop, you must notify Airstream to allow it to work directly with the service shop to have repairs performed. The repair remedy and the back-up

remedy MUST both be exhausted AND these remedies must fail to fulfill their essential purpose before you can seek other legal or equitable remedies for breach of this express warranty or for breach of any implied warranty. This limited warranty is not a warranty that promises or extends to future performance because the warranty does not make a representation on how your travel trailer will perform in the future but instead represents only what the remedy will be if a defect exists.

Unless prohibited by state law, repairs will not extend the time when you must commence a breach of warranty claim and shall not extend the warranty coverage period. Any performance of repairs after the warranty coverage ends OR any performance of repairs to those portions of your travel trailer excluded from coverage shall be considered “good will” repairs. Warranty repairs should be expected. Airstream may use new and/or remanufactured parts and/or components of substantially equal quality to complete a repair. Damage to interior or exterior surfaces, trim, upholstery, and other appearance items may occur at the factory during assembly, during delivery of the travel trailer to your selling dealer or on the selling dealer’s lot. Normally, any damage is detected and corrected at the factory or by the selling dealer during the inspection process. If you discover any damage when you take delivery of your travel trailer, you MUST notify your dealer OR Airstream within 10 days of the date of purchase to have damage repaired at no cost to you. Minor adjustments, such as adjustments to the interior or exterior doors, drawers, latches will be performed at no cost to you by your selling dealer during the first 90 days of warranty coverage; thereafter, such adjustments are your exclusive responsibility as normal maintenance.

What Is Not Covered

1. Tires, batteries, stereo, television, range/stove, furnace, refrigerator, air conditioner, toilet, water heater, microwave, generator, glass breakage, axle alignment, and other materials, parts and components warranted by persons or entities other than Airstream. Please refer to the warranties of component manufacturers for terms and conditions of coverage;
2. Components of the multiplex systems, including monitoring and control, and related hardware and software manufactured and/or warranted by persons or entities other than Airstream.
3. Accessories and equipment that are working as designed, but which you are unhappy because of the design;
4. Any part or component of the travel trailer that was not manufactured or installed by Airstream;
5. Normal deterioration due to wear or exposure, including but not limited to upholstery, flooring rust, corrosion, oxidation, and cosmetic blemishes;
6. Normal maintenance and service items, including but not limited to light bulbs, fuses, lubricants, sealants and seals, door adjustments, and awning tension;
7. After-market equipment or accessories installed on the trailer after completion of manufacture by Airstream, or any defects or damage caused by such items;
8. Travel trailer not purchased through an authorized dealer of Airstream and travel trailers purchased directly or indirectly through auction, salvage, repossession, or other non-customary sale means;
9. Any travel trailer used other than for temporary recreation purposes, including, but not limited to, use of the travel trailer for residential, rental, business and commercial purpose or any travel trailer purchased by, registered by, or titled in the name of a business association (such as any LLC, corporation, or partnership). If the travel trailer owner or user files a tax form claiming a business or commercial tax benefit or income related to the travel trailer, it shall be irrefutable that the travel trailer has been used for rental, commercial or business purposes.
10. Defects or damage caused by, in whole or in part, or in any way related to: Accidents, misuse (including off-road use), or negligence; Failure to comply with the instructions set forth in any owner’s manual provided with the travel trailer; Alteration or modification of the travel trailer except such alterations or modifications approved in writing by Airstream; Acts of God or other environmental conditions, such as lightning, hail, salt causing rust, or other chemicals in the atmosphere; De-icing agents or other chemicals applied to the travel trailer; Failure to properly maintain or service the travel trailer, including but not limited to the maintenance of lubricants, sealants, and seals; Condensation and the results of condensation including water damage and the growth of mold or mildew. Mold and mildew are natural growths given certain environmental

General Information

conditions and are not covered by the terms of this Limited Warranty; The addition of weight to the travel trailer that causes the total weight to exceed applicable weight ratings, or addition of weight causing improper distribution of the weight of the travel trailer; Failure to seek and obtain repairs in a timely manner; Failure to use reasonable efforts to mitigate damage caused by defects; Failure to properly ventilate the travel trailer; Improper electric power supply or improper travel trailer hookup to other facilities; Acts or omissions of any person or entity other than Airstream. (Note: An irrefutable presumption arises that the travel trailer has been used for commercial and/or business purposes if the travel trailer owner or user files a tax form claiming any business or commercial tax benefit related to the travel trailer, or if the travel trailer is purchased, registered or titled in a business name.)

11. Software embedded in Airstream products; mobile applications and other software which may be downloaded to smartphones and other devices; advanced monitoring, control, and other services offered by or on behalf of Airstream in connection with such embedded software, mobile applications, and downloadable software; and data transmission, hotspot, and other connectivity services associated with your travel trailer.

Obtaining Warranty Service

In order to obtain warranty service under this Limited Warranty, the owner must do all of the following:

1. Owner and dealer representative must complete, sign, and return the Customer Performance Checkout within 10 days from delivery of the trailer;
2. Notify Airstream or one of its authorized, independent dealers, of any claimed defect within the warranty period or 10 days thereafter;
3. Provide notification of a defect within 10 days of discovery of that defect; and
4. Promptly return the travel trailer to an authorized Airstream dealer or Airstream for repairs.

If you believe a defect covered by this Limited Warranty still exists after an attempted repair by an authorized Airstream dealer, you must contact Airstream in one of the following manners, and specify:

1. The complete serial number of the travel trailer;
2. The date of original purchase and the date of original delivery;
3. The name of the selling dealer; and

4. The nature of the problem and the steps or service which have been performed.

Email: support@airstream.com

Phone: (937) 596-6111

Mail: AIRSTREAM, INC., 428 West Pike Street, P.O. Box 629, Jackson Center, Ohio 45334-0629, Attention: Owner Relations Department

Airstream may direct you to an authorized Airstream dealer, or may request that you bring your trailer to the Airstream factory in Jackson Center, Ohio for repairs.

Airstream does not control the scheduling of repairs at its authorized Airstream dealers, and repairs at the Airstream factory may not be immediately available. Therefore, you may encounter delays in scheduling repairs and/or completion of repairs. All costs associated with transporting the travel trailer for any warranty service shall be the sole responsibility of the owner.

Events That Discharge Airstream's Obligations Under This Limited Warranty

Misuse or neglect, accidents, unauthorized alteration, failure to provide reasonable and necessary maintenance (see Owner's Manual), damage caused by off road use, collision, fire, theft, vandalism, explosions, overloading in excess of rated capacities, and use of the travel trailer for commercial, business, or rental purposes shall discharge Airstream from any express or implied warranty obligation.

Legal Remedies

Exclusive jurisdiction for deciding legal disputes relating to alleged breach of express warranty and breach of implied warranties arising by operation of law as well as those relating to representations of any nature rests in the courts within the state of manufacture, which is Ohio. Also, this limited warranty shall be interpreted and construed in accordance with the laws of the State of Ohio. Any and all claims, controversies, and causes of action arising out of or relating to this limited warranty, whether sounding contract, tort or statute, shall be governed by the laws of the State of Ohio, including its statute of limitations, without giving effect to any conflict of law rule that would result in the application of the laws of a different jurisdiction. If state law gives you additional rights that conflict with any term of this limited warranty, your state law applies over inconsistent warranty terms. For example, if you took delivery of your RV in California, the Song Beverly warranty act applies because it cannot be waived.

Airstream Limited Warranty Excludes

Normal Wear

Items such as curtains, upholstery, floor coverings, window, door, and vent seals will show wear or may even wear out within the 3-year warranty period, depending upon the amount of usage, weather, and atmospheric conditions.

Accident

We strongly urge our dealers and customers to inspect the trailer upon receipt of delivery for any damage caused by accident while being delivered to the dealer, or while it is on the dealer's lot. Damage of this nature becomes the dealer or customer's responsibility upon acceptance of delivery, unless Airstream is notified and the person making the delivery verifies the damage. Glass breakage, whether obviously struck or mysterious, is always accidental and covered by most insurance policies.

Abuse

Lack of customer care and/or improper maintenance will result in early failure for which Airstream cannot be held responsible.

Chemical Gassing

Chemical gassing is not a "Defect" in your recreational vehicle and is not covered by the Limited Warranty. Please follow the recommendations in this manual to address this concern.

Exposure

Not unlike a car, the steel parts of a trailer can and will rust if subjected to prolonged exposure to moisture, salt air, or corrosive air-borne pollutants without repainting. Aluminum oxidizes when unprotected under similar conditions, and refinery chemicals of a sulfurous nature are harmful to finishes if not washed off periodically. Extremely hot or direct sunlight will deteriorate rubber and fade curtains and upholstery. Conditions of this nature, although they may be normal for the area, are beyond Airstream's control and become the responsibility of the owner.

It is the responsibility of the owner to take such preventative measures as are necessary to maintain the exterior caulking and sealer of your trailer. It is the responsibility of the owner to use reasonable, prudent care to prevent foreseeable secondary damage from rain, plumbing leaks, and the natural accumulation of moisture in your trailer, such as a delaminated floor; stained upholstery, carpeting, or drapes, mold formation and growth, furniture damage, etc. Mold is a natural growth, given certain environmental conditions, and is not covered by the terms of the Limited Warranty.

Overload

Damage due to loading, either beyond capacity or to cause improper towing because of improper balance, is beyond Airstream's responsibility. The Airstream trailer is engineered to properly handle the gross vehicle load rating on the certification label. Load distribution has a definite effect upon the towing characteristics and attitudes of the trailer. Level hitch installations are a necessity, and very important on a tandem axle trailer. There are limits to the amount of load that can be safely transported, depending upon speed and road conditions, and reasonable cause to believe these factors have been exceeded could void the Airstream warranty. For additional information on the loading of your trailer, consult this Owner's Manual or gross vehicle weight rating plate.

The axle is manufactured to a tolerance of 1-degree camber and 1/8 in. toe-in. These tolerances will only change if the trailer is subjected to abuse, such as dropping off a sharp berm, striking a curb, or hitting a deep hole in the road. Such damage could be considered as resulting from an accident, of which risks are not covered under the warranty. Abnormal tire wear and/or wheel alignment resulting from such damage is not covered under the terms of the warranty.

General Information

Service

Coach-Net® Roadside Assistance



Every new Airstream comes with a three-year, transferable subscription to Coach-Net which includes a long list of premium services to help quickly solve issues or learn about your Airstream.

To learn more, scan the QR code above, navigate to <https://www.airstream.com/owners/coach-net/>, or call Coach-Net at 855-817-1885. On-call technicians are always ready to answer questions.

Service Centers

Before leaving the factory, every vital part of the trailer is tested for performance. Each test is signed and certified by an inspector. After the trailer arrives on your dealer's lot, all vital parts and systems are again tested. When you take delivery of your new trailer, you will receive a complete check out.

At that time, a specified list of performance checks on your trailer equipment will be conducted, and any deficiencies you have experienced since taking delivery will be corrected.

Please contact your dealer if your trailer needs service. Major service under your Airstream Limited Warranty is available through our nationwide network of Airstream Dealer Service Centers. To find a dealer, please visit, www.Airstream.com to use our dealer locator.

Occasionally, dealerships change, or new dealers are added that may not appear on the website immediately. Please note that all centers operate on an appointment basis for the utmost efficiency.

When you require service for your trailer from the Airstream Factory Service Center, or a Certified Dealer Service Center, please contact the service manager for an appointment, and inform them if you are unable to keep the appointment date, or wish to change it. Service may be arranged at the Factory Service Center by contacting the Service Coordinator at:

Airstream Factory Service Center,

428 West Pike Street

P.O. Box 629

Jackson Center, Ohio 45334-0629

Phone: (937) 596-6111 or (877) 596-6111

NOTE

MyAirstream App Control features and systems may be turned off while in a service facility for the safety of our technicians. You may have to re-pair your personal device after service appointment.

Reporting Safety Defects

If you believe that your vehicle has a defect which could cause a crash or could cause injury or death, you should immediately inform the National Highway Traffic Safety Administration (NHTSA), in addition to notifying Airstream Inc.

If NHTSA receives similar complaints, it may open an investigation, and if it finds that a safety defect exists in a group of vehicles, it may order a recall and remedy campaign. However, NHTSA cannot become involved in individual problems between you, your dealer, or Airstream Inc.

To contact NHTSA, you may either call the Vehicle Safety Hotline toll-free at 1-888-327-4236 (TTY: 1-800-424-9153), go to www.safercar.gov, or write to:

Administrator,

NHTSA,

1200 New Jersey Avenue, S.E.,

Washington, DC 20590.

You can also obtain other information about motor vehicle safety from www.safercar.gov.

Camping

Suggested Pre-Travel Check List

Interior

1. Turn off water pump switch.
2. Close windows and vents.
3. Lock all interior cabinet doors.
4. Latch refrigerator door. (Seal containers first.)
5. Hold down or securely stack all loose, hard, and sharp objects.
6. Fasten sliding and foldette doors.
7. Drain toilet bowl.
8. Turn off interior lights.
9. Set table in upright position.
10. Pull up or retract step.
11. Lower blinds.
12. Secure and lock main door.

Exterior

1. Disconnect and stow the electrical hookup cord, and the sewer (flush out), and water hookup hoses.
2. Turn off gas at LP tanks.
3. Retract stabilizing jacks.
4. Check hitch for proper attachment.
5. Check safety chains and breakaway switch cable.
6. Fully retract hitch jack. Remove and stow jack stand or wood block.
7. Check clearance and stoplights.
8. Check lug nuts.
9. Check tires for correct pressure.
10. Adjust tow vehicle mirrors.
11. Pull forward about 50 ft., test brakes, and check site for forgotten objects and cleanliness.

Trailer Equipment and Accessories

1. Water hose, 5/8 in. high pressure, tasteless, odorless, non-toxic, (2 25-ft. sections)
2. Y connection -- water hose.
3. Sewer hose with clamp.
4. Drain cap with hose drain.
5. Holding tank cleaner and deodorizer.
6. Power cord adapter, 50 to 30-amp capacity.
7. 30 ft. electric cord, 50-amp capacity.
8. Woodblocks for leveling.
9. Wheel chocks.
10. Hydraulic jacks.
11. Cross-type lug wrench and a torque wrench.
12. Quality tire gauge.
13. Emergency road warning triangle.

Motoring Essentials

1. Display the tow vehicle and trailer registration properly.
2. Carry driver's license.
3. In Canada, bring along a non-residence liability insurance card and your passport.
4. In Mexico, you must have special auto insurance.
5. Carry an extra set of the ignition and truck keys in a separate pocket, or in your wallet.
6. Keep an operating flashlight with fresh batteries in the glove compartment.
7. Pack the trunk so that you can reach the tools and spare tire without completely unpacking.
8. Keep sharp or hard articles securely packed.
9. Carry a first-aid kit.
10. Carry your pet's dish, food, leash, and health and registration papers.

General Information

Overnight Stop

Airstream owners have parked virtually in every place imaginable, from filling stations to farmlands. In time, you'll develop a knack for spying wonderful little roadside locations by turning off the main highway and exploring.

There are many modern parks, including State, County, and Federal parks, with good facilities where you might obtain hookups of electrical, water, and sewer connections. Directories are published which describe in detail these parks and tell what is available in the way of services and hookups.

On overnight or weekend trips, chances are you will not use up the capacity of the sewage holding tank, deplete the water supply, or run down the batteries that supply the 12-volt current.

On a longer trip, when you have stayed where sewer connections and utility hookups were not available, it will be necessary for you to stop from time to time to dispose of the waste in the holding tank and replenish the water supply. Many truck stops and gas stations, chain and individually owned, have installed sanitary dumping stations for just this purpose. Booklets are available that list these dumping stations.

When stopping for the night, your Airstream is built to be safely parked in any spot that is relatively level and where the ground is firm. Your facilities are with you. You are self-contained. Unless the tow vehicle is needed for transportation, it is not necessary to unhitch.

⚠ DANGER

At each campsite, make sure you have not parked in such a manner as to block the operation of the escape window by being too close to trees, fences, or other impediments. Scenic views are one reason for traveling, but don't park so the beautiful lake or steep cliff is just outside your escape window.

Choose the most level parking spot possible. Stabilizing jacks or blocks may not be required for an overnight stay. However, if you put the jack pad on the hitch jack and run the hitch jack down to take the weight off the tow vehicle's springs, it will provide some stability. If you must park on a slope, park facing downhill. It is easier to level the trailer this way.

All you need to do to enjoy the self-contained luxury of your Airstream is to turn on the LPG and light any appliance pilot lights.

Before moving on, check your campsite, both for cleanliness, and to be sure you have not left anything behind. Turn off the gas supply and make sure everything is properly stowed. Use your pre-travel check list and you are ready for more travel adventure.

Extended Stay

Making a long trip in your Airstream is not very different from making a weekend excursion. Since everything you need is right at hand, you are at home wherever you go. When packing for an extended trip, take everything you need, but only what you need.

When you plan to stay in the same place for several days, weeks you will want your trailer to be as level and steady as possible. Check the attitude with a small spirit level set on the inside work counter or the trailer hitch A-frame. If a correction is necessary, you must level from side to side first. This can be done easily by backing the trailer up onto one or more 2 x 6 boards. We do not recommend placing tires in a hole to level.

Leveling

Block or chock the wheels to keep the trailer from rolling. Level from front to rear by disconnecting the hitch from the tow vehicle, putting the jack pad under the hitch jack, and adjusting the jack up or down until the trailer is level. Use stabilizing jacks at all four corners, as shown in the diagram, to eliminate the natural spring action of the axles.

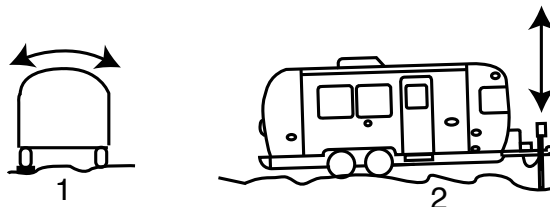

1. Side to Side
2. Front to Rear

Stabilizing Jacks

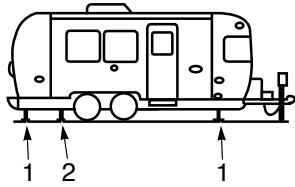

1. Stabilizing Jack Location
2. Lifting Jack Location

⚠ WARNING

Stabilizing jacks should only be used to stabilize the trailer. Do not use jacks to lift the trailer.

⚠ WARNING

Whenever the trailer must be lifted with a jack, as when changing a tire, always place the lifting jack under the main frame rail. A label is provided to indicate the proper position for the jack. Never use stabilizing jacks to lift the trailer.

For more information on jacking, see [Tire Changing on page 8-5](#).

Effects Of Prolonged Occupancy

Your trailer was designed primarily for recreational use and short-term occupancy. If you expect to occupy the trailer for an extended period, be prepared to deal with condensation and the humid conditions that may be encountered.

Moisture can condense on the inside surfaces of the trailer during cold weather when relative humidity of the interior air is high. This condition is increased because the insulated walls of a recreation vehicle are much thinner than house walls. Also, the relatively small volume and tight, compact construction of modern recreational vehicles means the normal living activities of even a few occupants will lead to rapid moisture saturation. Estimates indicate a family of four can vaporize up to three gallons of water daily through breathing, cooking, bathing, and washing. Unless the water vapor is carried outside by ventilation or condensed by a dehumidifier, it will condense on the inside of the windows and walls as moisture, or in cold weather, as frost or ice. It may also condense out of sight, within the walls or the ceiling, where it will manifest itself as warped or stained panels.

Appearance of these conditions may indicate a serious problem. When you recognize the signs of excessive moisture and condensation in the trailer, action should be taken to minimize their effects.

Tips To Control Condensation

Allow excess moisture to escape to the outside when:

- Bathing, washing dishes, hair drying, etc.
- Laundering, using appliances, and using non-vented gas burners.
- Cooking (Always use the stove vent hood).

Avoid dead air spaces by:

- Using a fan to keep air circulating.
- Leaving closet and cabinet doors partially open.

To help alleviate cold weather condensation:

- Keep the temperature as reasonably cool during cold weather as possible.
- Allow your trailer to breathe; do not make it airtight.
- Allow some warm air to be removed and some cool outside air in.
- Do not allow the furnace to recycle humid interior air; provide reasonable ventilation.

In hot weather, starting the air conditioner early will help remove excess humidity from the air while lowering temperatures.

NOTICE

Your trailer is not designed, nor intended, for permanent housing. Use of this product for long-term or permanent occupancy may lead to premature deterioration of structure, interior finishes, fabrics, carpeting, and drapes. Damage or deterioration due to long-term occupancy may not be considered normal, and may, under the terms of the warranty, constitute misuse, abuse, or neglect, and may therefore reduce the warranty protection.

Molds

Molds are microscopic organisms that naturally occur in virtually every environment, indoors and out. Outdoors, mold growth is important in the decomposition of plants. Indoors, mold growth is unfavorable. Left unchecked, molds break down natural materials such as wood products and fabrics. Protect your investment by understanding the potential risks mold imposes.

Contributing Factors To Mold Growth

For mold growth to occur, temperatures, indoor or outdoors, must be between 40° and 100°F, and must also have a source of moisture, such as humidity,

General Information

standing water, damp materials, etc. Indoors, the most rapid growth occurs with warm and humid conditions.

Inhibiting Mold Growth

By controlling relative humidity, the growth of mold and mildew can be inhibited. In warm climates, use of the air conditioner will reduce the relative humidity. Vents are located in the bathing and cooking areas. Constant use of these vents is advised during food preparation and bathing, even during colder weather. Additionally, opening a window during these activities will assist in ventilation. In extremely humid conditions, the use of a dehumidifier can be helpful.

Frequent use of your trailer or cleaning regularly are important preventive measures. Additionally, any spills should be wiped up quickly and dried as soon as possible. Avoid leaving damp items lying about. On safe surfaces, use mold-or mildew-killing cleaning products. Check sealants regularly, and reseal when necessary to avoid water leaks. Proper preventive maintenance to the trailer and its accessories, as described both in this manual and in accompanying literature, will provide the best protection to the trailer.

For more information concerning controlling moisture in the trailer, see [Tips To Control Condensation on page 3-9](#).

NOTICE

If using a dehumidifier, please read and follow all manufacturer instructions and recommendations for the use and cleaning of the dehumidifier.

Wastewater System

The main parts of the waste water system are the toilet, holding tanks, and tank dump valves; see [Drain and Waste System on page 8-14](#). The system is designed to provide complete self-contained toilet facilities, while on the road or parked, without being connected to a sewage line. It may also be used in the stationary position while connected to a sewage hose.

Keep the dump valves closed with either method and empty the tanks when they are nearly full. The idea is to send a large volume of water through the tanks and hose at the same time to float solids away.

After the sewage tank has been emptied, close the dump valves and put approximately 5 gallons of water in the sewage holding tank using the waste tank flush inlet. This will spray the interior of the tank with water and help prevent solids from building up in the sewage holding tank. The addition of a deodorizing agent like Aqua-Kem will help prevent odors.

Should you ever have a buildup of solids, close the valves, fill the tanks about 3/4 full with fresh water, drive a distance to agitate the solids, and drain the tanks.

Things Not To Put Into Toilet Or Drains

- Facial tissues and feminine hygiene products (they do not dissolve like toilet paper).
- Automotive antifreeze, ammonia, alcohols, or acetone.
- Table scraps or other solids that may clog the drains.

28RB Model

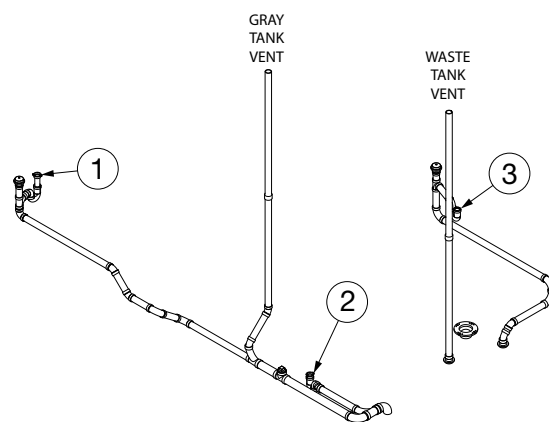

1. Galley Drain
2. Lavatory Drain
3. Shower Drain

30RB Model

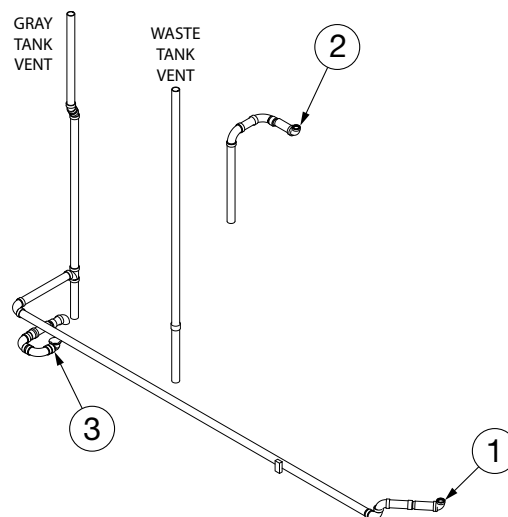

1. Galley Drain
2. Lavatory Drain
3. Shower Drain

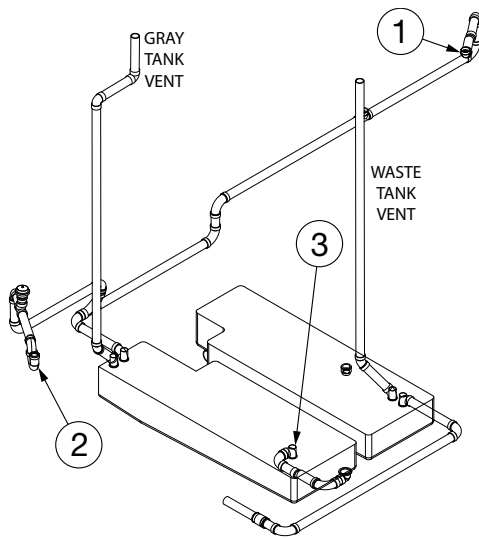
33FB Model

1. Galley Drain
2. Lavatory Drain
3. Shower Drain

Winter Traveling

Traveling in sub-freezing temperatures will require certain precautions to protect the plumbing system and your personal belongings from being damaged by freezing.

Whenever possible, the heat should be kept set to a constant temperature. It is easier for the furnace to keep a constant room temperature than allow the trailer temperature to drop to 50°F, and then attempt to raise it to room temperature.

Some states do not allow LPG to be turned on while moving. While traveling in these states, simply use your common sense. How cold is it? How long will it be before you can turn the heat back on? Is the temperature dropping or rising? Remember, when towing at 50 MPH, the wind chill factor will cause the interior of the trailer to cool much faster than a trailer that is parked.

1. When parked in sub-freezing temperatures, make sure to keep a full supply of LPG and plug into an external AC power source whenever possible.
2. If your stay is longer than overnight, you should try to have 120-volt electricity available. Minimize the use of electricity if a 120-volt power source is not available.

3. Leave cabinet doors, wardrobes, and bed doors partially open to allow warm air to circulate around plumbing lines and fixtures. Insulate and/or wrap your exterior water lines with heat tape.
4. Save 12-volt power by using non-toxic RV-approved antifreeze in the holding tanks instead of the heating pads to prevent freezing. Quantity of antifreeze needed will vary with ambient temperature and the amount of liquids in tanks.

Tank Heaters

The fresh water tank, waste water tank, and gray water tank all have 12-volt tank heater pads controlled from the multiplex touchscreen or pushbutton controls; see [Home Screen - Tank Heater Pads](#) on page 5-17 and see [Control Panel Pushbuttons](#) on page 5-20.

Turn ON the tank heaters when the outside temperature nears freezing. Once activated, the heaters will cycle on when the tank's contents drop below 44°F and automatically turn off when the contents reach 64°F. Turn the switches off when outside temperatures remain above freezing and upon emptying the tanks.

NOTE

While the tank heaters are effective, they can quickly deplete the battery. Plan to have an external power source available whenever possible.

NOTICE

Drain and winterize the trailer if the water systems are not being used during winter traveling. Refer to [Section 8 - Maintenance](#) for winterizing instructions.

AIRSTREAM®

Section 4 FLOOR PLANS AND SPECIFICATIONS

FLOOR PLANS4-2
28RB Classic4-2
30RB Classic4-2
33FB Classic.4-3
SPECIFICATIONS4-4
Specifications Chart4-4
Specification Tags.4-5
Measuring Hitch Ball Height4-5

Floor Plans And Specifications

Floor Plans

28RB Classic



30RB Classic



33FB Classic



Floor Plans And Specifications

Specifications

Specifications Chart

NOTE

All product information and specifications listed are as accurate as possible at the time of printing. Since we continually strive to improve our products, all specifications are subject to change without notice. All capacities are approximate and dimensions are nominal and are checked and updated throughout the model year.

Item	Model		
	28RB	30RB	33FB
Exterior length	28' 10"	31' 5"	33' 3"
Exterior width	8' 5.5"	8' 5.5"	8' 5.5"
Exterior height with A/C	9' 7"	9' 7"	9' 7"
Interior width	8' 1"	8' 1"	8' 1"
Interior height with A/C	6' 7"	6' 7"	6' 7"
Hitch ball height	19.5"	19.5"	19.5"
Hitch ball size	2 5/16"	2 5/16"	2 5/16"
UBW (lbs. with LP & batteries)	7,650	7725	8425
Hitch weight (lbs. with LP & batteries)	875	830	1150
GVWR (lbs.)	8,800	10000	10000
Front GAWR (lbs.)	4400	4400	4400
Rear GAWR (lbs.)	4400	4400	4400
NCC (lbs.)	1,150	2275	1575
Fresh water tank (gal.)	39	53	53
Gray water tank (gal.)	37	34	34
Waste water tank (gal.)	35	39	39
Lug nut torque (Max), aluminum wheels (ft lbs.)	110	110	110
Lug nut torque (Max), steel wheel (spare) (ft lbs.)	100	100	100
Tire size	LT225/75R16		
Tire Max cold* inflation pressure (psi)	90		
Tire Max load rating (lbs.)	2680		

*The term *cold* refers to how long a tire has sat idle. *Max cold inflation pressure* should be checked in the morning (after sitting idle for at least three hours) before driving more than a few miles, or before rising ambient temperatures and the sun's radiant heat can affect tire pressure.

The Unit Base Weight (UBW) and Net Carrying Capacity (NCC) weights listed in the Specification Chart are for the base unit with LP and batteries included.

Gross Vehicular Weight Rating (GVWR) is the maximum permissible weight of this trailer when fully loaded. It includes all weight at the trailer axle(s) and coupler.

UBW is the dry weight of the base unit without options.

NCC is equal to GVWR minus UBW. Gross Axle Weight Rating (GAWR) is the value specified as the load carrying capacity of a single axle system, as measured at the tire-ground interfaces.

Specification Tags

For precise cargo capacity, refer to the Cargo-Carrying Capacity tag on the inside of the screen door. The **WEIGHT OF CARGO SHOULD NEVER EXCEED** numbers shown on the tag, which is the maximum weight of cargo you can load and carry in your specific trailer as built with its options.

Located on the front roadside of your trailer are the Tire and Loading, and Vehicle Manufacturing tags.

The Tire and Loading information tag lists the Size and Cold Inflation Pressure of the tires on your vehicle, the weight of your trailer as manufactured, and the GVWR.

The Vehicle Manufacturing tag lists the Size of tires and wheel rims, Maximum Cold Inflation pressures, the Vehicle Identification Number (VIN), and GAWR.

Measuring Hitch Ball Height

The proper height will vary according to the weight you carry and the tires you use. However, checking the height on your trailer is relatively easy:

1. With trailer parked on fairly level ground, measure from ground to bottom of frame, front and rear.
2. Adjust front jack until measurements are equal.
3. Now, measure from ground to the inside top of ball coupler. This figure is the hitch height. The hitch ball is then usually set 1/2 to 1 in. higher, according to the spring rate of your tow vehicle, to allow for it to settle when the trailer is hitched up.

AIRSTREAM®

Section 5 INTERIOR

GENERAL INFORMATION AND CLEANING	5-3	ELECTRICAL SYSTEM OVERVIEW	5-8
Upholstery	5-3	Power Center	5-8
Curtains and Shades	5-3	Circuit Breaker Protection	5-9
Interior Woodwork	5-3	Ground Fault Circuit Interrupter (GFCI)	5-9
Interior Aluminum Skin	5-3	GFCI Breaker Test	5-9
Counter Area	5-3	120-Volt Electrical System	5-10
Sinks	5-3	City Power	5-10
Luxury Woven Vinyl Floor	5-4	120 VAC Outlets/Receptacles	5-10
Interior Doormat and Rug Selection	5-4	Converter/Charger	5-10
Shower Stall	5-4	Inverter	5-10
Shower Head	5-4	Batteries and 12 Volt DC System Information	5-11
Shower Door Sweep/Seal	5-4	Solar System	5-11
Retractable Clothesline	5-4	ELECTRICAL SYSTEM OPERATION	5-12
Power Dinette Table	5-5	Battery Disconnect	5-12
Power Sofa	5-5	24-Hour Key Switch	5-12
Storage Tips	5-5	Batteries	5-12
Safe	5-5	Battery Management System (BMS)	5-13
PLUMBING	5-6	High Voltage Disconnect	5-13
Water System (Self-Contained)	5-6	Low-Voltage Disconnect	5-13
Water Pump	5-6	Battery Heaters/Cold Weather Usage	5-14
Draining System	5-6	Battery Charging	5-14
Fresh Water Lines and Tanks	5-6	Battery State-of-Charge (SOC)	5-14
Drain and Waste System	5-6	Shoreline Connection Charging	5-15
Toilet	5-7	Tow Vehicle to Trailer Charging	5-15
Deodorizers and Biological Chemicals	5-7	Solar Power Charging	5-15
Faucets	5-7		
Galley Faucet	5-7		
Lavatory Faucets	5-7		

Section 5 Interior

Multiplex System5-16	APPLIANCES5-22
Navigating the Touchscreen5-16	Appliance Manufacturer's Manuals5-22
Home Screen - Introduction5-16	Maintenance5-22
Home Screen - Battery Disconnect5-17	Air Conditioner and Integrated Heat Pump5-23
Home Screen - Modes5-17	Air Conditioner Filters5-23
Home Screen - Inverter5-17	Cooktop5-23
Home Screen - Tank Heater Pads5-17	Ceiling Vent Fans5-23
Home Screen - Shoreline Detection5-17	Cleaning Instructions5-23
Home Screen - Tire Pressure Monitor System5-17	Exhaust Vent5-24
Home Screen - Water Pump5-17	Operation5-24
Lighting and Awning Control Screens5-18	Cleaning Instructions5-24
Air Conditioner Control Screen5-18	Fuse5-24
Ceiling and Bath Vent Fan Control Screen5-19	Furnace and Water Heater5-24
Settings Screen5-19	System Maintenance5-24
Control Panel Pushbuttons5-20	Control Panel5-25
MyAirstream App5-20	Interior Temperature Settings5-25
Pairing your Smartphone5-20	Hot Water Settings5-25
Privacy Statement5-20	Energy Settings5-25
ENTERTAINMENT SYSTEMS5-21	Microwave Ovens5-25
TV and Sound System, 28RB/30RB Models5-21	Monitor Panel5-25
TV and Sound System, 33FB Model5-21	Viewing Tank Levels5-26
TV Lift Operation5-21	Viewing Battery Voltage5-26
Device Connection5-21	Refrigerator5-26
Blu-ray/DVD Player and Streaming Device Connection5-21		
TV and Audio Component Pairing5-21		
Smartphone and Stereo Pairing5-21		
USB Stereo Connection5-21		
Cable/Satellite Connection5-21		
All-In-One Antenna5-22		
Antenna Booster5-22		
Internet5-22		
Mobile Internet5-22		
Ethernet Connection5-22		

General Information and Cleaning

The interior of all Airstream trailers has been designed for comfort, convenience, durability, and appearance. How you use it and how you take care of it, naturally, depends on you. However, if you learn to operate the interior components and take care of them and the trailer properly, this knowledge will add to your pleasure, as well as the long life of your trailer. All material should be professionally dry cleaned to remove any overall soiled condition.

Upholstery

The best way to keep your Ultraleather seating looking great is regular cleaning to prevent excess dirt from accumulating. To help extend the life of the fabric, wipe up spills as soon as they occur. Clean with soap and water. Sanitize using disinfectants such as (1:5) bleach/water solution. For stubborn stains, wipe off with isopropyl alcohol as soon as possible. Thoroughly rinse all solution residue with clean water and air dry.

NOTICE

Never remove cushion covers for separate dry cleaning or washing. Any tumble cleaning method can destroy the backing, and/or shrink or otherwise damage upholstery fabric.

Curtains and Shades

The curtains are on a track. Undo the velcro at the seams to slide them open. Airstream recommends dry cleaning only for the curtains. To remove them, remove the top screw from the endcap of the curtain track, pull the endcap off, and slide the curtains off.

Spot clean the shades only. Prepare a solution of warm water and a mild detergent. Dampen a clean cloth in the solution and wring it out. Dab the spot with the dampened cloth until it is gone. **Do not rub the fabric!** Allow the shade to dry in the completely lowered position.

Interior Woodwork

The finish on the interior woodwork is a high quality furniture finish and should be treated as any fine furniture finish. Use a high quality furniture cleaner which does NOT contain ammonia or bleach. One good choice is Murphy Oil Soap Clean and Shine.

Interior Aluminum Skin

Interior aluminum skin can be cleaned by washing skin with any mild non-abrasive soap or detergent. Cleaning should be followed by a thorough clean water rinse. Drying the unit with a chamois or a soft cloth may prevent spots and streaks. Do not use abrasive cleaners or utensils on the aluminum skin as it is coated with a clear coat that could be damaged.

NOTICE

When washing or polishing your trailer, always wipe with the grain of the metal.

Counter Area

The countertops are made of a solid surface and can be cleaned with soap and water, or you can use a common solvent on tough spots. Do not use abrasive cleaners since they could scratch the surface. A protective pad should always be used under hot utensils or pans. A light sanding of minor damaged areas can repair the counters. The color of the material is constant and not just a surface coat.

Sinks

Cleaning can be accomplished using a mild liquid detergent on a soft cloth.

Luxury Woven Vinyl Floor

One of the best ways to keep the floor looking good is to wipe fabrics off on a weekly basis with clean water. This helps prevent dirt from becoming deeply embedded in the fabric and eliminates the need for more vigorous cleaning. For general or light cleaning, brush off loose dirt and wipe down the floor. Prepare a solution of water and mild soap such as dish washing liquid or household cleaner. Using a soft bristle brush to clean, apply a small amount of water and soap mixture to the stain. Rinse thoroughly until all soap residue is removed. Allow the floor to air dry. For more stubborn stains and mildew, prepare a solution of 1 cup bleach and 1/4 cup mild soap per gallon of water. Apply a small amount of bleach and soap mixture to the stain and blot with a sponge or clean towel. Rinse thoroughly to remove all soap residue. Allow to air dry. A citrus based cleaner like D-Limonene can be used for tough dirt and grease spots. Ammonium based products are NOT recommended. All cleaning products need to be rinsed off thoroughly and air dried after cleaning.

NOTICE

Remember to protect the area around your flooring if using a bleach solution. Other fabrics may have an adverse reaction to cleaners containing bleach.

NOTICE

The use of certain cleaning agents, including but not limited to powdered abrasives, solvents, and industrial strength cleaners is not recommended. Always follow the manufacturer's instructions.

Interior Doormat and Rug Selection

To avoid staining or discoloration of vinyl flooring, only use doormats or rugs made of natural fibers. The rubber-backed mat provided by Airstream is suitable for outdoor use only.

NOTICE

Rubber or latex-backed mats or furniture with rubber feet may stain or discolor vinyl flooring.

Shower Stall

Wet the shower surface and clean it using a non-abrasive sponge or soft cloth and a non-abrasive liquid detergent cleaner safe for acrylic, gelcoat, and fiberglass bath surfaces. Avoid using acidic or harsh commercial bath cleaners. Rinse and dry with a soft towel. A wax or sealer suitable for these surfaces can be applied to the stall to restore gloss to dull areas when necessary, but should not be used on the shower floor as this could create an unsafe, slippery surface.

For models with Decatone wall tile installed, use soft non-abrasive detergents and a soft nylon brush. Stubborn stains may require the use of hypochlorite bleach dissolved in water. Avoid the use of strong bleaches, organic detergents and abrasive brushes, these could discolor and scratch the surface.

⚠ WARNING

Applying wax to the shower floor is not recommended and could create an unsafe, slippery surface.

Shower Head

The shower head facilitates water-saving when camping without a fresh water hookup. To conserve water while showering with fresh tank water, turn the water off between lathering and rinsing.

Shower Door Sweep/Seal

Models with a glass shower door have a sweep or seal at the bottom to help contain water within the shower. The door sweep is a commonly replaced item that requires periodic inspection and cleaning. The sweep will accumulate mold, mildew, and soap residue due to its location and the humid environment. This buildup can prevent the sweep from creating a good seal and may cause the seal to drag and tear. To prolong the lifespan of the sweep, clean it regularly, especially with increased shower use.

NOTICE

To avoid water damage, the shower door sweep/seal must be replaced if damaged. Inspect, clean, and replace the shower door sweep as necessary.

Retractable Clothesline

A retractable clothesline is installed for your convenience in the shower stall. To use, pull the line from the base and attach it to the holder on the opposite wall. Turning the nut on the base will tighten the line.

Power Dinette Table



To make the power dinette into a bed, press and hold the electric switch on the end of the galley, to lower the table into position. To complete the conversion you will need the cushions that cover the table top. These cushions can be stored in the wardrobe. Lay the cushions on the table top, side by side. The cushions may rest slightly higher on the table top than the seat cushions.



Power Sofa

In all models the sofa can be reclined for an added sleeping area using the power controls on the inside of each armrest. There is a USB C outlet inside each arm in addition to switches that control footrest recline and bed/back recline.

Storage Tips

Galley cabinets should have the heaviest items stored on the bottom and lighter items overhead. After loading, put skillet and canned goods on the floor or bottom shelf, and cereals and crackers in the overhead roof locker. Use unbreakable-type plates and saucers, and consider storing your dish towels around them.

Clothes hung in wardrobes should be kept on hangers that snap over the clothes rods to keep them from bouncing off on rough roads. Try to avoid large bulky coats. Layers of lighter clothing will usually keep you warmer, are more versatile, and are easier to store.

Two bungee cords have been provided and should be strapped around the front of the ottoman to hold it in place. Airstream recommends securing the ottoman during travel to prevent damage.

⚠ WARNING

Keep flammable material away from the furnace and vents.

Safe

The Classic Airstream trailer is equipped with a safe. The safe is hidden in the floor of the wardrobe below a false panel.

Plumbing

Water System (Self-Contained)

Fill the water tank by opening the exterior access door and remove screw cap. A drinking water safe hose can now be inserted. It's a good idea to let the water run through the hose for a short time to flush it out. Experienced RVers usually fill their tanks with "home" water to avoid strange water that may be distasteful to them. The amount of water in the tank may be checked on the Monitor Panel, or you may fill the tank until water overflows out of the fill.

Open the hot side of the galley or lavatory faucet and turn on the water pump using the Multiplex control panel. For some time, the open faucet will only sputter. This is because the water heater is being filled and air is being pushed out through the lines. Once the water heater is full, a steady stream of water will flow from the faucet. Now, open a cold faucet. It will sputter for a short time, but will soon expel a steady stream. All other faucets can now be opened until all air is expelled. Once the system is filled with water and the faucets closed, the water pump will shut off. When a faucet is opened, the pump will come back on automatically. If the faucet is just barely open, it is normal for the pump to cycle on and off rapidly.

Water Pump

The water pump is controlled by the Multiplex Control Panel or remote pushbutton switch located on the bathroom wall; [see Multiplex System on page 5-16](#). When turned on, the water pump's controller maintains a consistent regulated water pressure and steady water flow based on demand.

The water pump is typically left off when hooked up to a city water supply. However, if city water pressure is lower than desired the water pump can be turned on to facilitate increased water pressure, provided there is a supply of water in the fresh water tank. The tank will be depleted by the amount needed to supplement the flow of city water.

Access to the water pump will be necessary for periodic cleaning of the strainer screen; [see Water Pump Access Locations on page 8-11](#) and [see Strainer Cleaning on page 8-11](#).

NOTICE

Road vibration may force a faucet open in transit. Ensure the pump is OFF prior to travel.

NOTE

If water flow is interrupted, check the water supply and turn the pump off and back on.

Draining System

Fresh Water Lines and Tanks

The fresh water system's water lines have low point drain valves and can be drained. The fresh water tank has a valve and can also be drained; [see Fresh Water Tanks and Draining on page 8-12](#).

Drain and Waste System

Your trailer has a drain and waste system that includes waste-holding tanks made from corrosion-free molded plastic, with trouble-free dump valves.

The waste water holding tank enables you to use the toilet for several days away from disposal facilities. The wastewater from the sink, shower, bath and lavatory drains into the gray water holding tank.

Each tank has its own dump valve with both tanks draining through a common outlet. Therefore, only one sewer hose connection is needed when hooking up to a dump station.

Almost all campgrounds will have dumping facilities. Park directories, such as Woodalls and Rand McNally, also list dumping stations; [see Drain and Waste System on page 8-14](#).

Check your monitor panel frequently; [see Monitor Panel on page 5-25](#). When the waste water holding tank is completely full, sewage cannot be emptied from the toilet bowl. If the gray water holding tank is overfilled, drain water may back up into the shower floor pan and cause an unpleasant cleaning job. Never drain the tanks at any place other than an approved dumping station.

NOTICE

Never put wet strength paper towels or tissues in your holding tank since they won't dissolve and can catch in the mechanism of the dump valve. Colored toilet tissue is slower to dissolve than white. Most RV-accessory stores offer tissue designed for RVs that will completely dissolve.

Toilet

The toilet in the 28RB and 30RB Classic is a design that has been used for many years. There is only one pedal. This pedal opens and closes the slide mechanism, and opens the water valve. In normal use, depressing the pedal dumps the sewage and flushes water down the side of the bowl. Water will continue to run into the bowl for a short time after the pedal is released. When you wish to conserve water, hold the hand-spray head (if equipped) over the bowl and hold down the thumb-operated lever. When depressing the pedal, all the water is routed through the hand-spray.

The toilet used in the 33FB Classic is similar to the toilet in your home. It has a hand flush that dumps sewage and flushes the bowl.

NOTICE

When you dump the bowl of the toilet, make sure all paper and solids have cleared the slide mechanism before you allow it to close. Failure to do so can cause the groove for the slide to become jammed and the slide will no longer close completely.

Please see the toilet owner's/user manual for warranty and user tips, and maintenance information.

Deodorizers and Biological Chemicals

There are many deodorizers and processing chemicals on the market in tablet, liquid, and powder form. These not only combat odor, but also stimulate the bacteria that works to dissolve the solids and tissues in your waste tank. These chemicals should be introduced through the toilet prior to use per the manufacturers directions. It's also important to always add a few gallons of water by filling the toilet bowl a few times and depressing the foot pedal.

Faucets

Galley Faucet



Airstream Part #602437

Grohe - Model 30300DC0

Lavatory Faucets

28RB/30RB



Airstream Part #602813-01

Moen - Model 6190

33FB

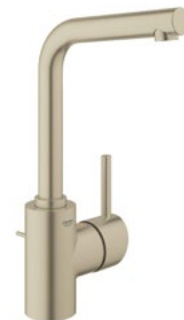

Airstream Part #602439

Grohe - Model 23737EN2

Electrical System Overview

The electrical system in your Airstream is designed to be flexible and adapt to different usage scenarios. The MyAirstream app enables you to monitor and control your trailer's various systems from anywhere with your smartphone – whether you're inside the trailer, nearby, out hiking, or even miles away.

The electrical system's self-contained 12-volt DC (12V) portion features two 100Ah 12V LiFePO4 batteries. The 12V system powers items like the Multiplex System, power awning, lights, refrigerator, fans, and water pump. A 2000-watt 12V-120V pure sine inverter, which converts 12V electricity from the batteries into 120-volt AC (120V), allows you to enjoy entertainment features while camping without relying on external power sources.

An external shoreline hookup (campground/city power or generator) provides power for comfort and convenience appliances like the heating and hot water system, air conditioning, microwave, entertainment systems, and all 120-volt outlets. It also provides power to the converter, transforming 120-volt AC from a shore connection to 12-volt DC to charge the batteries and power 12V systems.

The following sections provide an overview of the electrical system and its components. For detailed information on how to operate and monitor the system, see [Electrical System Operation on page 5-12](#).

Power Center



The Power Center is a self-contained 120 Volt AC (120 VAC) distribution panel that houses the travel trailer's circuit breakers and fuses. Its primary function is to provide load safety protection for 120 VAC loads and is central to the overall electrical system.

The Power Center is behind a finished wood panel at the bottom of the refrigerator on the 28RB and at the bottom of the wardrobe on the 30RB. The 33FB Power Center is behind the upholstered side panel of the aft booth seat. To remove a panel, pull outward at the edge to release it from the spring-loaded catches holding it in place.

Circuit breakers and fuses are labeled inside the power center door.

⚠ WARNING

The power center is a centralized power switching, fusing, and distribution center. The potential for lethal electrical shock is present in this box. Inadvertent shorts at this box could result in damage and/or injury. All servicing of this box should be done by a qualified Service Technician.

⚠ WARNING

Disconnect/De-energize all main power service, shore power/generator power/battery power/solar power/inverter power before servicing the breaker panel.

Circuit Breaker Protection

Standard residential-style (resettable) circuit breakers protect all 120 VAC loads. Airstream has installed breakers per RVIA (NEC) listing requirements.

Incoming shore power is routed to the distribution panel, where several breakers provide circuit load protection. With the exception of the inverter circuit, the main breaker turns off power to all branch circuits. Breakers are identifiable by the affixed labels. In the event of a 120-volt circuit failure, check the breaker for the shoreline power source and the trailer's power distribution circuit breakers.

Like a light switch, the breaker's up position is ON, and down is OFF. If an overload or short occurs, the breaker will snap to the OFF position to protect the connected circuit. As a result, any device running on the circuit will lose power. Before attempting to reset the breaker, consider the cause. If a connected device is faulty or uses a higher amperage than the circuit breaker's capacity, turn it off before resetting the breaker.

Resetting a breaker requires external AC power going to the breaker box. Firmly push the breaker switch to the OFF position and back to the ON position. If the breaker snaps back to the OFF position during the reset, it indicates a fault condition that still exists and should be addressed by a qualified Service Technician. Similarly, if the breaker stays ON but snaps back OFF after turning on a potentially faulty appliance, it suggests a fault condition in that appliance that will require service by a qualified Technician.

Ground Fault Circuit Interrupter (GFCI)

The GFCI breaker provides reliable overload and short-circuit protection. GFCI breakers protect against ground faults and provide additional safety to the occupants on all outlets/receptacles. A ground fault occurs when current travels along an unintended path to ground, possibly through water or a person, which may result in an electric shock. The GFCI compares the amount of current going to and returning from the device plugged into the circuit's outlet/receptacle. When the amount of current going to the device differs from the amount returning, the GFCI interrupts the current within a fraction of a second, removing power from the circuit, and protecting the user.

Each GFCI circuit breaker is calibrated to trip with a ground current of 5 mA or more. Since most people can feel as little as 2 mA, a shock may be felt. The shock should be of such a short duration that the

effects would be reduced, less than what would normally be a dangerous level. However, persons with acute heart problems or other conditions that can make a person particularly susceptible to electric shock may still be seriously injured.

While the GFCI circuit breaker affords a high degree of protection, there is no substitute for knowing that electricity can be dangerous when carelessly handled or used without reasonable caution.

The system incorporates GFCI breakers that implement an auto-self-test functionality. When turned off, these breakers require external AC power to be present before they can be turned back on. If power is present, and the breaker refuses to stay on, consult an electrician or certified RV technician.

⚠ WARNING

The GFCI circuit breaker will NOT reduce shock hazard if contact is made between a HOT load wire and a neutral wire or two HOT load wires. GFCI circuit breakers provide protection only to the circuit to which it is connected.

GFCI Breaker Test

Perform this test on the GFCI circuit breaker each month and record the date.

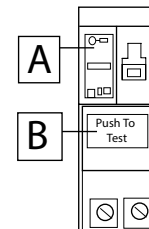

1. With handle A in the "ON" position, press PUSH TO TEST button B.
2. Handle A should move to the TRIP position, indicating that the GFCI breaker circuit is open.
3. Move handle A to the "OFF" position and back to the "ON" position to restore power.

If the device remains on when the Test button is pushed, the GFCI is not working properly or has been incorrectly installed (wired improperly). If your GFCI is not working properly, call a qualified, certified electrician who can assess the situation, rewire the GFCI if necessary, or replace the unit.

NOTICE

All GFCI breakers implement an auto self-test function, however, Airstream recommends a manual test be conducted every month.

120-Volt Electrical System

City Power

When connected to shoreline (city) power, the 120-volt electrical system provides power to operate the air conditioner, converter/charger, entertainment systems, and 120-volt receptacles. Incoming shore power is routed to the distribution panel, where several breakers provide circuit load protection, and power is distributed to each appliance or receptacle.

When your trailer is hooked up to external AC power, the converter system automatically charges the trailer batteries regardless of the position of the battery disconnect switch.

If you are making an extended stay, you should keep your trailer hooked up to a 120-volt current if it is available. The speed and degree of charge depend on how much power is used for lights and appliances, as only the surplus goes to charging the battery.

120 VAC Outlets/Receptacles

There are several power outlets, both inside and outside of your Airstream. Most outlets require an external power source to function. Some outlets, such as those for the TVs, are connected to the inverter circuit and are labeled accordingly; [see Inverter on page 5-10](#)

Converter/Charger

The converter transforms 120-volt AC shoreline power into 12-volt DC to operate 12V systems and charge the batteries. The converter/charging system is the interior low-voltage electrical system that enables you to use the interior lights, fans, pumps, refrigerator, and 12-volt appliance components, whether operating on self-contained battery power or 120-volt city power. The converter system is designed to maintain constant output voltages regardless of the variances in city power systems.

If the converter is not powering 12V systems, check the external power source to ensure you have shoreline power. If you have shore power, check the distribution panel breakers; [see Circuit Breaker Protection on page 5-9](#).

Inverter

The 2000-watt DC to AC pure sine inverter converts 12-volt DC into 120-volt AC. Its operation is controlled from the multiplex touch screen, [see Home Screen - Inverter on page 5-17](#) or from the MyAirstream app, [see MyAirstream App on page 5-20](#). The inverter powers the TVs, entertainment devices, and 120-volt outlets on the inverter circuit. To operate outlets on the inverter circuit, typically labeled 'inverter,' the inverter must be ON unless connected to shoreline power.

If inverter power is unnecessary, it can be turned OFF to conserve battery power.

NOTE

Overloading the inverter will cause an automatic shutoff to activate. Removing the load will allow the inverter to reset.

Batteries and 12 Volt DC System Information

12-volt DC (12V) current passes through the battery system in the front of the trailer; [see Batteries on page 5-12](#). The power sources listed below and branch circuits (12V lights, pumps, motors, refrigerator, and 12V appliance components) are all protected by the 12V distribution panel fuses located in the Power Center. Some 12V circuits may have in-line fuses at or near the powered device.

Power sources that supply 12V current to the system are as follows:

- Main charge line from tow vehicle
- Trailer batteries
- Solar
- Converter

If any 12-volt appliance fails to operate, check your 12-volt distribution fuse block and inspect the fuses. Replace blown fuses only with the same type and amperage size previously used. If you replace a blown fuse and it immediately blows again, do not replace the fuse again. Have a qualified service technician troubleshoot and identify the problem. If the replacement fuse holds for a week or more and the gap in the fusible metal barely melts apart, this usually indicates an overload condition. Reducing the number of lights or appliances used on that particular circuit simultaneously could prevent further fuse failure.

Solar System

The rooftop solar panels installed on your Airstream help maintain battery health, reduce operating expenses, and extend the life of the batteries. The solar system's solar charge controller gathers energy from the individual solar panels and stores it in your batteries. The Victron SmartSolar charge controller is configured to optimize the charging process. SmartSolar maximizes energy-harvest, driving it intelligently to achieve full charge in the shortest possible time.

Solar charge information is displayed on the Multiplex touchscreen, [see Home Screen - Introduction on page 5-16](#) and on the MyAirstream app, [see MyAirstream App on page 5-20](#).

In addition to the factory-installed solar panels, a quick plug-in port suitable for a portable solar charging kit has been pre-wired at the front of the unit near the propane tanks. Portable solar panel kits MUST include a solar controller set to a Lithium profile and cannot have an output of more than 15 amps. The solar port is fused at 15 amps in a holder in the battery box. For solar wiring, [see 12-Volt Main Schematic on page 8-20](#) and [see Solar Panel Wiring on page 8-27](#).

Electrical System Operation

Battery Disconnect

The disconnect switch separates the batteries from the 12-volt distribution panel. If the trailer is disconnected from shore power and the switch is turned OFF, the batteries are disconnected, the 12-volt fuse panel will not receive power from the converter or batteries and the inverter will turn off.

The batteries will be charged through the converter charging system, solar system, and tow vehicle regardless of whether the battery switch is ON or OFF.

There are a few ways to operate the battery disconnect:

- From inside the trailer using the  pushbutton near the main entry door, [see Control Panel Pushbuttons on page 5-20](#).
- By pressing the battery disconnect icon on the multiplex touchscreen, [see Home Screen - Battery Disconnect on page 5-17](#).
- By pressing the battery disconnect icon on the MyAirstream app, [see MyAirstream App on page 5-20](#).
- Manually turning the disconnect rotatory dial.

24-Hour Key Switch

The key switch in the front roof locker controls power to the Multiplex System's SCU (System Control Unit), multiplex touchscreen, cabin fans, and LTE router (if aftermarket-equipped).

When turned OFF, remote monitoring capability using the MyAirstream app will not be available until the key is turned back ON.

NOTE

If the multiplex display is ON but is not functioning, verify the 24-hour key is ON. The 24-hour key must be ON to use the touchscreen.

NOTE

When there is no shoreline power or solar energy available during storage, you can turn off the 24-hour key in addition to the battery disconnect switch to conserve battery power. App control will not be available if the key is off.

NOTE

Technicians may need to turn off the 24-hour key during service.

Batteries



Your Airstream Travel Trailer is equipped with two 100Ah 12V LiFePO4 batteries with built-in battery management. The batteries are in a box behind the LP tank cover on the A-frame.

The information in this manual touches on the highlights of the battery system's essential functions and operation. Before operating the system, please read the Battleborn literature in your Owner's Packet for important warnings/limits, operating instructions, storage, and maintenance instructions. For more information, scan the QR code above or visit <https://battlebornbatteries.com/>.

Lithium-ion batteries outperform traditional lead-acid batteries and offer more usable energy. They have a life span of approximately 3000-5000 cycles. A discharge and a charge determine a cycle. The number of cycles a lithium battery can sustain varies by use. A battery that is only ever discharged to 50% will have more cycles than a battery repeatedly discharged to 0%.

Lithium batteries provide longer life and faster charging than lead-acid batteries while still providing 80% of the rated capacity after thousands of cycles. Unlike lead-acid batteries, which require water replacement, lithium batteries require no active maintenance. The use of lithium batteries in Airstream's travel trailer also delivers more energy at typically half the weight of a traditional battery.

For information on the various battery charging methods, [see Battery Charging on page 5-14](#).

WARNING

The Airstream Owner's Packet includes an owner's manual for the lithium batteries. Before operating, make sure to read, understand, and follow all information, such as Notes, Cautions, and Warnings.

NOTICE

When installing a battery, always observe polarity. Connecting a battery in reverse polarity will blow the power converter main fuses.

Battery Management System (BMS)

The BMS is an internal component of the batteries and is crucial to ensuring safe operation. The BMS monitors cell voltages, currents, and temperatures to ensure they operate in a safe range and will shut the batteries down should any faults occur. The following are features of the BMS:

- Over/under voltage protection
- High current protection/short circuit
- High-temperature protection
- Low-temperature charging protection
- Cell balancing

High Voltage Disconnect

If an individual cell voltage exceeds a prescribed threshold during charging (approx. 14.7V), the BMS will prevent a charge current from continuing. Discharge is always allowed under this condition.

NOTICE

Even though the BMS will protect against issues from overcharging, it should be avoided. The recommended specs are 14.2-14.6 bulk/absorb and below 13.8 float.

NOTE

If the battery has not been balanced for a long period, a high voltage disconnect could occur at a lower voltage. The battery will rebalance after several full charges.

Low-Voltage Disconnect

If an individual cell falls below a prescribed threshold during discharge (approx. 10.5V), the BMS will prevent further discharge. Should this occur, connect to external power using the shoreline power cord to bring the battery out of the low-voltage disconnect and fully charge the battery. Bringing a battery out of low-voltage disconnect only “wakes” the battery and allows it to accept a charge. Without shore or generator power, the battery may go back into low-voltage disconnect.

NOTICE

The manufacturer states you should charge (wake) your battery within 24 hours of entering low-voltage disconnect; otherwise, you risk damaging the battery and voiding the warranty.

NOTICE

If the battery is in low-voltage disconnect mode and the battery temperature is below 35°F, the heat function will need some time to warm the battery before performing the wake-up procedure.

NOTE

The system is calibrated at Airstream, however, if the batteries are disconnected or fully discharged, past the state of BMS protection, the Smart Shunt will need to be recalibrated. To do so, the batteries must be fully charged to a peak voltage of 14.3 volts. If the shunt is not calibrated correctly, the SOC status in the MyAirstream app may appear dashed out. The converter has a maximum charge time of 4 hours, which may not be long enough to fully charge the batteries. To continue charging, disconnect the shoreline power supply and reconnect. This will allow the converter to continue charging for another 4 hours.

Battery Heaters/Cold Weather Usage

Lithium-ion batteries may not charge effectively if the internal temperature drops below 35°F (1.6°C). An internal heating element and switch have been added to allow battery usage and charging in cold weather.

The switch is on the side of the battery box. If the red portion of the switch is visible, the battery heaters are ON. When the switch is on, the heater will automatically activate when the internal temperature drops below approximately 35°F (1.6°C) and will shut off when the internal temperature exceeds approximately 45°F (7.2°C). The switch should be turned OFF when storing your trailer to prevent battery discharge.

The heated batteries consume an average of 1.8 amps. Testing indicates, that at 0°F, with no insulation, the heater would be on about 30% of the time. With no other loads or charging, the batteries would give approximately 185 hours of heat capability before the batteries would go into LBCO shutdown. These values are based off testing with the batteries at 100%.

Battery Charging

When the trailer is plugged into an external AC power source, the 12-volt distribution panel receives power from the converter, and the batteries are charged through the converter charging system regardless of whether the battery switch is on or off.

Both the solar system and tow vehicle-to-trailer charging will charge the batteries regardless of whether the battery disconnect switch is on or off.

Battery State-of-Charge (SOC)

The trailer has a Smart Shunt, which determines the batteries' state of charge (SOC). The multiplex system's home screen and the MyAirstream app display shoreline power status and power insights, including battery and solar monitoring information, [see Home Screen - Introduction on page 5-16](#) and [see MyAirstream App on page 5-20](#).

The system is calibrated at Airstream, however, if the batteries are disconnected or fully discharged, past the state of BMS protection, the Smart Shunt will need to be recalibrated. To do so, the batteries must be fully charged to a peak voltage of 14.3 volts. If the shunt is not calibrated correctly, the SOC status will appear dashed out.

Shoreline Connection Charging

Plug the cordset into an external power supply. Verify that only the cordset's blue LED indicator is illuminated and plug the other end into the trailer's roadside SmartPlug inlet. For more information about the LED indicator system, see [Shoreline Power Inlet and Cordset on page 6-7](#).

In some older parks and other locations where three-pronged outlets are not available, certain precautions to ensure proper grounding and polarity must be taken. These precautions are listed below:

1. Attach the four-pronged plug to a two-pronged adapter. The third conductor line of this adapter has a short wire lead, that must be grounded.
2. For proper grounding, connect the short ground lead to a grounded outlet box or to a cold water pipe. When no water pipe is available, drive a metal rod two feet into the ground and attach the ground lug to it, thus, providing the unit with proper grounding.

NOTE

When the four-pronged plug can be used, there will be no problems with proper polarity or grounding with a properly wired shoreline outlet.

NOTE

The converter has a maximum charge time of 4 hours, which may not be long enough to fully charge the batteries. To continue charging, disconnect the shoreline power supply and reconnect. This will allow the converter to continue charging for another 4 hours.

Automatic Micro-Controller Operation

The power converter's 2-stage switch mode is fully automatic. The converter senses which mode it needs to be in by checking the condition of the batteries. The two modes include:

Absorption Mode: During this mode the converter output is in the 13.6 VDC range. This is the mode that the converter will function at normally. This mode provides the 12 VDC and the current required by the trailer.

Bulk Mode: In this mode, the output voltage of the converter will switch to 14.6 VDC range for a maximum of four hours. If the converter cycles between "Absorption and Bulk modes", there could be a shorted battery cell or other issues.

Tow Vehicle to Trailer Charging

Your Airstream's batteries can be replenished, depending on the tow vehicle, from the tow vehicle alternator through the 7-way cord. This charge will flow to the batteries regardless of the battery disconnect switch position.

Solar Power Charging

The solar panels will still charge the batteries regardless if the battery disconnect switch is on or off. The solar charging system is primarily used to help maintain a charge between shoreline or tow vehicle charging; see [Solar System on page 5-11](#).

Multiplex System

The Multiplex System, with MyAirstream app control capability, provides advanced onboard automation and mobile solutions for conveniently controlling and monitoring your Airstream's various systems and features.

A touchscreen display and conveniently located pushbutton control panels keep everything within reach while on board. With features like Bluetooth Low Energy (BLE), LTE connectivity, and GPS, you can stay connected and in control using the MyAirstream app from anywhere – whether you're inside the trailer, nearby, out hiking, or even miles away (some features may require a subscription); [see MyAirstream App on page 5-20](#).

NOTICE

Airstream is committed to continuously improving system features through software testing and development to provide the best user interface. As a result of these improvements and firmware updates, the images and illustrations in this section may vary from the actual screen display.

NOTE

If the multiplex display is ON but is not functioning, verify the 24-hour key is ON; [see 24-Hour Key Switch on page 5-12](#).

Navigating the Touchscreen

- Touch the display to wake from sleep/standby.
- Swipe right or left to navigate between screens.
- Press **AIRSTREAM** to return to the home screen.
- Control icon colors indicate status. Example:

 = OFF  = ON

Items Controlled

Battery Disconnect	Inverter
Air Conditioner/Heat Pump	Power Awning
Lights	Fans
Tank Heaters	Water Pump



Items Monitored

Shoreline Connection Status	Battery State-of-Charge
Solar Power	Tank Capacity
Tire Pressure/Temperature	Interior Temperature

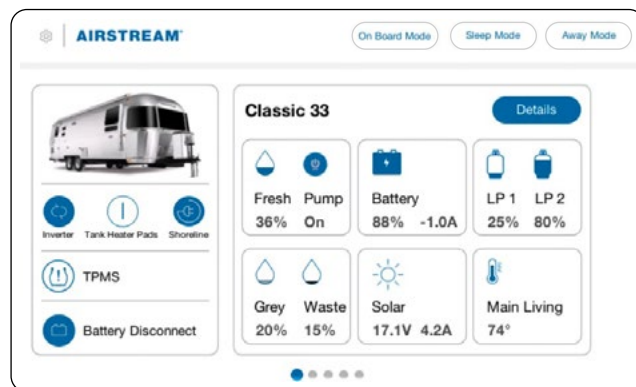
Home Screen - Introduction



The home screen conveniently displays ON/OFF controls for certain features, real-time system status and alerts, power insights, tank capacities, and interior temperature.

The yellow alert symbol  (low level/low capacity) and red alert symbol  (very low level/no capacity) appear at the edge of icons to indicate an item needs attention. These alerts indicate a limit or capacity has been reached, or a fault condition exists. On the home screen, touch inside the icon's tile or tap on the icon to access additional details.

Alarm Conditions

Tire Pressure Monitoring Alarm	Low Pressure/Fault
Low Battery Power Alarm	25% Remains
Very Low Battery Power Alarm	15% Remains
Low Fresh Water Alarm	20% Remains
Very Low Fresh Water Alarm	10% Remains
Grey Water Low Capacity Alarm	85% Full
Grey Water No Capacity Alarm	95% Full
Waste Water Low Capacity Alarm	85% Full
Waste Water No Capacity Alarm	95% Full
LP Tank 1 Low Alarm	20% Remains
LP Tank 1 Very Low Alarm	10% Remains
LP Tank 2 Low Alarm	20% Remains
LP Tank 2 Very Low Alarm	10% Remains

Press  to access a scrolling list of detailed capacities and power insights.

Home Screen - Battery Disconnect

To turn the battery disconnect ON, press  on the home screen. When turned OFF, a warning will appear to acknowledge, *Batteries are Disconnected*. For more information, see [Battery Disconnect on page 5-12](#).

Home Screen - Modes

Below is a list of what each available mode will activate or deactivate. This list is subject to change with product developments and improvements. Away and sleep mode both put the touchscreen to sleep; touch the screen to wake.

	On Board Mode	Away Mode	Sleep Mode
Awning	N/A	RETRACTS	N/A
Touchscreen Display	ON	SLEEP	SLEEP
Main Ceiling Lights	ON	OFF w/Timer	OFF
Galley Lights	ON	OFF	OFF
Bedroom Ceiling Lights	ON	OFF w/Timer	OFF
Bedroom Accent Lights	ON	OFF	OFF
Bathroom Lights	ON	OFF w/Timer	OFF
Grab Handle Light	ON	OFF	ON
Aisle Motion Lights	OFF	OFF	ON

⚠ CAUTION

Away Mode retracts the awning. Do not operate the awning without first visually inspecting it to ensure nothing is obstructing its operation and close the main door prior to operating the awning.

Home Screen - Inverter

To turn the inverter ON, press  on the home screen. The inverter powers entertainment systems and 120-volt outlets on the inverter circuit. If inverter power is unnecessary, it can be turned OFF to conserve battery power; see [Inverter on page 5-10](#).

Home Screen - Tank Heater Pads



Press  on the home screen to turn the tank heaters ON when outside temperatures near freezing. Turn the heaters OFF when outside temperatures remain above freezing and upon emptying the tanks. For more information, see [Tank Heaters on page 3-11](#).

Home Screen - Shoreline Detection

Once a shoreline connection is established, the  icon will turn blue to indicate shoreline power is present.

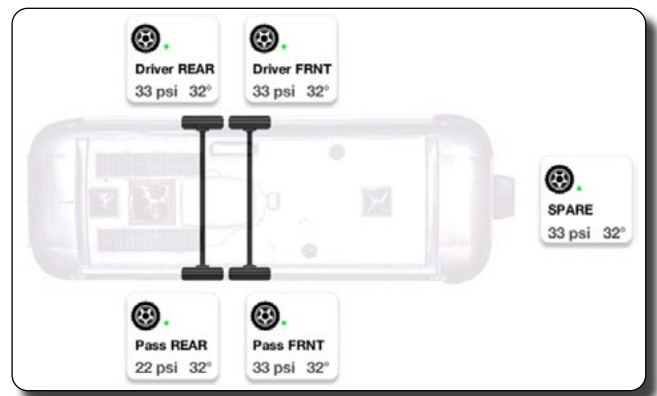
Home Screen - Tire Pressure Monitor System



The  icon on the home screen will display an alert symbol if the Tire Pressure Monitoring System (TPMS) detects low tire pressure or a fault. Press  to access the TPMS page. This page displays each tire's current pressure, temperature, and status in real time.

In the event of a TPMS alarm, the status symbol for the affected tire will change from green to red, indicating which tire needs attention. If enabled, the MyAirstream app will also send a push notification when there is a TPMS alarm.

Home Screen - Water Pump

The water pump can be turn ON or OFF by pressing  on the home screen. For more information about the water pump; see [Water Pump on page 5-6](#).

Lighting and Awning Control Screens



From the home screen, swipe left to access interior lighting controls (example on left) and again to access the exterior lighting and awning controls (example on right).

Each lighting icon represents a single light or a group of lights it controls. There are two types of lights: basic ON/OFF only, and dimmable.

The  icon controls ON/OFF only lights. Press once to turn the lights ON or OFF.

The  icon controls dimmable lights. Press once to turn the lights ON or OFF. Press and hold for 2-3 seconds to access a popup slide control and adjust the brightness as desired.

To use the awning control features, you must first unlock the awning by pressing and holding both awning tilt pushbuttons on the pushbutton control panel inside the main entry door; [see Awning Operation on page 6-5](#).

CAUTION

Do not operate the awning without first visually inspecting it to ensure nothing is obstructing its operation and close the main door prior to operating the awning. In addition to the controls described in this section, selecting Away Mode on the Multiplex panel also retracts the awning.

To access the awning control screen, press the  icon. A popup that allows you to open, close, or stop awning travel will appear. Tilt functions are only available at the pushbutton control panel.

Air Conditioner Control Screen



To use the air conditioner(s), you need a shoreline power supply connection. This screen will be suspended when disconnected from shore or generator power. For more information about the air conditioner, [see Air Conditioner and Integrated Heat Pump on page 5-23](#).

From the home screen, swipe left past the lighting control screens to access the air conditioner screen where you can control A/C unit(s) features like Cool Mode, Heat Mode (heat pump), and Fan Mode.

Depending on your model, select the tab for the appropriate living area you wish to control. Press the power ON icon and choose the desired mode: Cool, Heat, or Fan. Temperature values can be adjusted by pressing the up or down arrows or using the slider. The icon to the right of the slider controls fan speed. Available settings are Auto, Low, or High.

Ceiling and Bath Vent Fan Control Screen

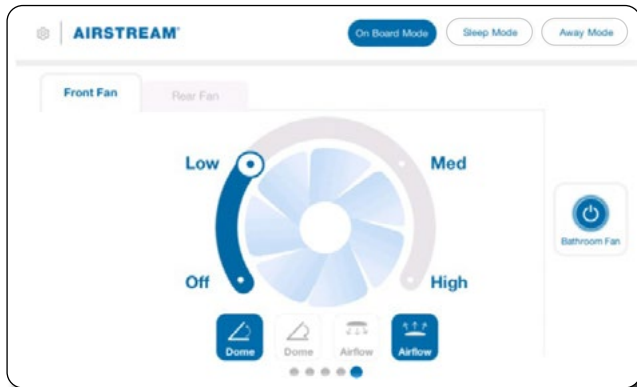

To control a ceiling vent fan, swipe left from the home screen past the lighting and air conditioner control screens to access the ceiling fan controls. Depending on your model, select the tab for the appropriate living area you wish to control. You can operate the fan with the dome open or closed and select the airflow direction to draw in air or force air out. Use the slider to adjust the fan speed as desired. The ceiling vent fans are equipped with a rain sensor. When the sensor gets wet the dome will close. For more information about ceiling vent fans, [see Ceiling Vent Fans on page 5-23](#).

To operate the bath vent using the multiplex system, you must first open the exhaust vent and ensure the manual switch mounted at the vent is ON; [see Exhaust Vent on page 5-24](#). Once it's ON, you can power the fan ON or OFF using the multiplex controls by pressing the Bathroom Fan power icon on the far right side of the screen.

Settings Screen

To access settings, press  in the upper left corner of the screen.



About

Press to access system information (VIN, serial numbers, etc.) and support.



Units

Press to access and configure units of measurement such as pressure, temperature, and volume.



Display

Press to access and adjust screen brightness and timeout duration.



BLE Pairing

Press to start the process of pairing your smartphone with the multiplex system for control using the MyAirstream app.



Diagnostics

Press to obtain status, error codes, and firmware version for troubleshooting.

Control Panel Pushbuttons

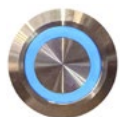

The multiplex system can be operated from the touchscreen display or MyAirstream app, but you can also control many functions using the pushbuttons conveniently located throughout your Airstream.

When a pushbutton is activated, the corresponding icon on the touchscreen changes, and vice versa.

When a touchscreen icon is pressed/activated, the corresponding pushbutton illuminates. The same is true for the MyAirstream app.

Some pushbuttons act as a simple ON/OFF switch, but some have multiple functions. The following is a guide to those that perform multiple functions. This list is subject to change with product developments and improvements.

On Board, Away, and Sleep Modes	Same functions as the touchscreen; see Home Screen - Modes on page 5-17 .
Awning Tilt	Press both tilt buttons to unlock the awning. Separately, they tilt the awning as labeled; see Power Awning on page 6-5 .
Exterior light Master	Press to turn ON the awning lights. Press again to turn ON the awning and step lights. Press again for OFF.
Interior Lights	Some lights can be dimmed by pressing and holding the pushbutton. They typically perform the same functions as the touchscreen; see Lighting and Awning Control Screens on page 5-18 .
Bathroom Lights and Fan	Press to turn ON the bathroom lights. Press again to turn ON the bathroom lights and bath exhaust fan. Press again for OFF.
Vent	Press to open or close the dome lid.
Fan L/M/H	Each press changes fan speed. Press and hold to change the fan airflow direction.

MyAirstream App



The MyAirstream app allows you to monitor and manage your trailer's various systems from your smartphone. The System Control Unit (SCU) communicates with the MyAirstream app via Bluetooth Low Energy (BLE) when in proximity to your Airstream or via LTE connection when away. The GPS feature lets you quickly find your way back to camp should you take a wrong turn. You can download the MyAirstream app from your smartphone's app store (some features may require a subscription).

Pairing your Smartphone

Your owner's packet contains instructions for pairing your smartphone to the system along with a unique QR code needed for setup. Prior to setup, confirm that the 24-hour key is turned ON; see [24-Hour Key Switch on page 5-12](#). If the QR code is misplaced, please contact Airstream customer service to obtain a replacement.

⚠ WARNING

Do not use the MyAirstream app on your smartphone when driving or when the RV is otherwise in motion. Serious damage to the RV or property or serious injury to yourself or others may occur as such systems or functions may distract your attention from the road.

NOTE

Turning the 24-hour key OFF disables GPS function and all other MyAirstream app services; see [24-Hour Key Switch on page 5-12](#)

Privacy Statement

Airstream respects your privacy. Your vehicle and related components (such as electronic control units), applications, and services may collect, store, and/or transmit certain data. Please review our Privacy Policy and the terms of service associated with your product available at Airstream.com for important information concerning our collection and processing of data and our privacy practices.

Entertainment Systems

TV and Sound System, 28RB/30RB Models



 28RB and 30RB models have Bluetooth Low Energy (BLE) enabled Smart TVs and a Fusion® Apollo™ Stereo with LCD color touchscreen display, BLE, advanced SiriusXM features, FM radio, AUX, and USB connectivity.

The Fusion-Link Remote Control App can be used to control stereo functions. To download the app, scan the QR code above, search for Fusion-Link on your device's app store, or click on one of the following icons:



TV and Sound System, 33FB Model



Your Airstream has a Klipsch® stereo and speaker system, that features a color TFT display, Bluetooth Low Energy (BLE), FM radio, AUX, and USB connectivity. The 33FB Classic also has Bluetooth Low Energy (BLE) enabled Smart TVs.

The Entertainment Center features a lift-operated smart TV connected to a dedicated Klipsch Flexus 200 Dolby Atmos soundbar that produces high quality sound and an immersive theater experience. Refer to your owner's packet for detailed instructions on how to operate the TV and sound bar.

TV Lift Operation

The TV lift is controlled with a remote. If the remote is misplaced or has a dead battery, you can raise and lower the TV with the wired remote found in the cubby at the end of the sofa. Avoid pressing the programming buttons (1, 2, and M). These are used to set the travel height of the TV. For detailed instructions on operating the lift, refer to the TV lift operating manual in your owner's packet.

Device Connection

The following sections provide basic instructions for connecting devices, which are subject to change with new product developments and improvements. Please refer to the TV and stereo manuals in your owner's packet for additional details. Some TV's also have manuals available through the on-screen menu.

Blu-ray/DVD Player and Streaming Device Connection

Blu-ray/DVD players and streaming devices can be connected to the main TV using the *Bring Your Own Device* HDMI/Ethernet wall port (located in the media roof locker). Devices can be powered using the outlet next to the HDMI/Ethernet wall port or by plugging them into the nearby USB port. Streaming devices require internet access; [see Internet on page 5-22](#).

TV and Audio Component Pairing

To pair the desired Bluetooth Low Energy (BLE) audio component (stereo/headphones/portable speaker) with your Airstream's TV, place the audio component into pairing/discoverable mode. Then, enter the TV's settings menu and follow the prompts to select the desired BLE device from the device list. Only one TV at a time can be played through the stereo via BLE.

Smartphone and Stereo Pairing

Most smartphones can be paired with a stereo to stream music. Place the stereo into pairing/discoverable mode, enable Bluetooth on your smartphone, and select the stereo.

USB Stereo Connection

To connect most smartphones and other digital media devices directly to the stereo, plug your device's USB cable into the USB port inside the media roof locker. Once connected, change the stereo's source from its current setting to USB.

Cable/Satellite Connection

You can establish an external cable TV or satellite connection by attaching a cable TV service provider's

coax cable, or a satellite coax cable, to the external roadside SmartPlug cable/satellite and ethernet inlet; see [SmartPlug Cable/Satellite and Ethernet Inlet on page 6-7](#). A receiver can be installed in the media rooflocker by removing the mounting plate and using coax to add the receiver between the cable input and output.

All-In-One Antenna



The roof-mounted antenna accommodates TV, AM/FM radio, cellular, WiFi, and GPS. It seamlessly provides TV and radio reception for entertainment, GPS and cellular to stay connected when away, and cellular/WiFi for internet access when equipped with an aftermarket router; see [Internet on page 5-22](#).

NOTICE

Do not powerwash or use harsh cleaning chemicals/solvents/alcohol to clean the antenna.

Antenna Booster

The antenna booster operates automatically and does not require any user interaction. If TV reception is poor, verify the antenna booster is plugged into the USB port on the back of the TV, and ensure the booster's small power switch is turned ON.

Internet

Airstreams have a few options to help you stay connected, stream entertainment, surf the internet, and share your adventures with family and friends.

Mobile Internet

The all-in-one antenna mounted to the roof of your Airstream is part of a prewire that is ready to accept an aftermarket router so you can stay connected with LTE mobile internet. Internet access may require a cellular plan for activation. The prewire leads are behind the access panel in the roof locker at the front of the trailer. Talk to your Airstream dealer about installation.

Ethernet Connection

Establish an internet connection by attaching a service provider's ethernet cable to the external roadside SmartPlug cable/satellite and ethernet inlet; see [SmartPlug Cable/Satellite and Ethernet Inlet on page 6-7](#). The inlet is routed to the *Bring Your Own Device* HDMI/Ethernet wall port (located in the media roof locker). A modem and WiFi router can be connected to the wall port via ethernet and powered by the nearby outlet.

Appliances

Appliance Manufacturer's Manuals

The appliances installed in your Airstream each come with a manual provided by the appliance manufacturer, which can be found in your owner's packet. It is important to read and follow the appliance manufacturer's instructions before using an appliance. These manuals contain important safety warnings and instructions on how to use and properly maintain the appliance.

The information contained in the appliance manuals supersedes any information contained in the Airstream Owner's Manual content on appliances. If you believe contradictory information on appliances is contained in this manual, or if any appliance manual(s) have not been provided with your Airstream, contact your dealer, the respective appliance manufacturer, or Airstream Customer Service at 937-596-6111 or email: support@airstream.com.

⚠ WARNING

Airstream recommends shutting off the gas supply at the LPG tanks before refueling the tow vehicle or entering a refueling station.

Maintenance

Follow the instructions and warnings noted in the respective appliance and equipment owner's manuals and those mentioned in this manual.

An authorized dealer or repair facility should conduct annual maintenance on propane gas appliances and equipment.

Insects can build nests in the burners of various appliances and equipment. The burner and burner orifice of the propane gas appliances and equipment should be cleaned by an authorized dealer or repair facility whenever circumstances or conditions warrant, but no less than annually.

⚠ DANGER

Most LPG appliances used in recreational vehicles are vented to the outside of the vehicle. When parked close to a gasoline pump, it is possible that gasoline fumes could enter this type of appliance and ignite from the burner flame, CAUSING A FIRE OR AN EXPLOSION.

Air Conditioner and Integrated Heat Pump

Air conditioners are controlled from the multiplex touchscreen; [see Air Conditioner Control Screen on page 5-18](#), and the MyAirstream app. Your owner's packet contains literature covering all operating and maintenance instructions for the installed A/C unit(s). If the literature is misplaced, contact the A/C manufacturer or your Airstream dealer for replacement.

A proper power supply is critical for air conditioner operation. A voltmeter check may find the voltage much lower at a campground shoreline outlet than the needed 110 to 120 volts. Low voltage is usually associated with older or poorly maintained trailer parks. Parking your trailer so the power cord can be plugged into a receptacle close to the fuse or circuit breaker box can alleviate low-voltage problems. Avoid extension cords and adapters whenever possible. If an extension cord must be used, it should be as short and heavy as possible to provide the most current.

If high temperatures are expected, taking proactive steps to manage the heat may be beneficial. Consider parking your trailer in a shaded area. Starting the air conditioner in the morning can help maintain a comfortable temperature throughout the day. It is usually more efficient to hold a comfortable temperature than to lower it after the trailer's interior has already heated up.

Air Conditioner Filters

The exterior sponge filter can be gently washed with soap and water as needed. The white pleated Merv 8 filter must be replaced. Replacement times will vary greatly depending on how often the air conditioner is used. With frequent use, the filter may last 3-4 months. With infrequent use, it may be possible to replace the filter annually. Contact your dealer or Airstream directly to obtain a replacement. For Airstream part numbers, [see Replacement Filters on page 8-4](#).

⚠ WARNING

Review the air conditioning literature supplied in your owner's packet before proceeding.

NOTE

If operating on 30 amp service, running the heat pump and furnace on electric together could cause the breaker to trip. It is recommend to be connected to 50 amp service or to minimize the use of other appliances while running the heat pump.

Cooktop

There is little difference between the operation of home gas ranges and the trailer's cooktop. Refer to the appliance manufacturer's directions in the owner's packet for instructions and safety information to learn how to use the cooktop with confidence.

⚠ WARNING

Your owner's packet includes a manual for the cooktop that contains specialized warnings and cautions that should be reviewed prior to operating the appliance. If this manual has not been included with your trailer, contact Airstream or the appliance manufacturer to obtain one.

Ceiling Vent Fans

Ceiling vent fans are controlled from the multiplex touchscreen, control panel pushbuttons, and the MyAirstream app; [see Ceiling and Bath Vent Fan Control Screen on page 5-19](#) or [see Control Panel Pushbuttons on page 5-20](#).

You can operate the fan with the dome open or closed and select the airflow direction to draw in air or force air out. To maximize airflow, close all other vents and open the window or door furthest from the vent fan. The ceiling vent fans are equipped with a rain sensor. When the sensor gets wet the dome will close.

NOTE

Do not close vent shades, if equipped, while using Exhaust Fan(s).

Cleaning Instructions

⚠ WARNING

Never operate a fan with the screen removed. Always disconnect power before maintenance. Review the manufacturer's instructions.

To clean the screen, turn OFF the fan, battery disconnect switch, and 24-key. The screen may be friction held or have retainer clips that need turned halfway to remove. Remove the screen and clean with a mild soap and water solution. Carefully pat dry with a soft cloth and reinstall.

NOTICE

The use of certain cleaners can cause cracking and product failure. Review the vent fan manufacturer's cleaning instructions.

Exhaust Vent



Operation

The bath exhaust vent (shown above) removes moisture and odors from the air. To operate, you first need to open the vent. To open the vent, push the button on the handle to disengage the clip and slide the handle upward until the clip engages. Once open, turn the fan on by pressing the ON/OFF button on the fan.

Once the fan is open and the manual switch is ON, you can control it from the multiplex touchscreen and MyAirstream app; see [Ceiling and Bath Vent Fan Control Screen on page 5-19](#). It is also controllable using the control panel pushbuttons, see [Control Panel Pushbuttons on page 5-20](#).

Turn the fan OFF before closing the vent. To close the vent, push the button on the handle to disengage the clip and pull the handle down until the clip engages in the lowered position.

NOTICE

Turn OFF the fan before closing the vent. Damage to the motor can occur if the fan runs with the vent closed.

Cleaning Instructions

⚠ WARNING

Never operate a fan with the screen removed. Always disconnect power before maintenance. Review the manufacturer's instructions.

To clean the screen, turn the fan motor and battery disconnect switch OFF. Remove the four retainer screws. Clean the screen with a mild soap and water solution only.

Fuse

To change the 5 Amp fuse:

1. Make sure the fan is off.
2. Remove the cap by turning it to the left to gain access.
3. Replace with a type GMA 5A fast-acting fuse.
4. Replace the cap to secure the fuse in the holder.

Furnace and Water Heater

The Alde heating and hot water boiler is a hydronic system that circulates hot glycol fluid through pipes while convectors along the outer walls heat the air. As the hot air rises, it heats the walls and surrounding furniture. When the warm air reaches the ceiling, it circulates back down to the floor and is reheated by the convectors.

The following is an overview of the system's function and operation. Before operating the system, please read the Alde manual in your owner's packet.

⚠ WARNING

Your owner's packet includes a manual for the Heating and Hot Water System that contains specialized warnings and cautions that should be reviewed prior to operating the appliance, as well as required maintenance. If this manual has not been included with your trailer, contact Airstream or the appliance manufacturer to obtain one.

The system can be operated on LP gas, electricity, or both and automatically provides smooth, effective temperature transitions. The boiler calculates whether or not it needs to raise output to achieve the selected temperature to maximize efficiency and avoid unnecessary energy consumption. The water heater can be operated independently or simultaneously, and the heating system can heat the interior without filling the water heater.

System Maintenance

The Alde System requires periodic user maintenance including checking Glycol levels and ensuring the hot water tank has an air cushion (air space at the top of the water tank); see [Heating and Hot Water System on page 8-18](#) and refer to your Alde manual for required maintenance intervals.

NOTICE

Only high-quality ready-mixed propylene glycol (with inhibitor) is intended for use in aluminum heating systems. The glycol must carry the label GRAS (generally recognized as safe). Alde recommends using only the ALDE brand glycol formulated explicitly for the Alde heating system.

NOTICE

The freshwater in the boiler should be drained during extended breaks and when there is a risk of frost; otherwise, the boiler may freeze, causing damage. The warranty does not cover frost damage.

Control Panel

Alde's touchscreen lights up when you press the screen or the MENU button. The status screen is shown when the control panel is in sleep mode. Press the relevant status screen icon to reach its sub menu. Press the menu button to reach the settings menu. If the status page is set to Dark, the control panel will go dark 30 seconds after it enters sleep mode, but will come on again when the screen is touched.

To start the boiler, press the control panel ON/OFF button. The start icon appears, and the system starts with the last selected settings. When the heating system and control panel are on, a green LED lights up on the On/Off button. To turn off the heating system, press the On/Off button. The control panel and LED will go out. A red LED indicates there is an error message.

NOTICE

The water heater must always be full of water when using Boost/Autoboost.

Interior Temperature Settings

The indoor temperature display shows the current temperature and whether the circulation pump is active. Tap the House/Indoor icon to change the desired temperature. Press + or - to set the desired temperature.

NOTICE

Allow air to circulate freely to achieve the best possible results from convection heat. Ensure that the air supply to the convectors is not obstructed.

Hot Water Settings

There are four hot water settings: No Hot Water (Off), Normal Operation (On), Boost, and Autoboost/Auto Mode. Boost prioritizes and increases hot water production when its needed and for 30 minutes after activation. It is recommended to activate boost a few minutes ahead showering. To activate, press the Hot Water icon on the menu screen and adjust the slider to 'Boost'. Turning ON the boost function temporarily suspends heat in the trailer and raises the water temperature. The system automatically returns to its previous setting after 30 minutes; however, it can be returned to normal operation at any time by changing the setting.

WARNING

Always check the water temperature before taking a shower or bath. High water temperature above 120 °F (49°C) can cause serious scalding

Energy Settings

The boiler can be powered by LP gas, electricity, or both. Press Energy to access energy settings. There are two pages for setting energy, which can be reached by pressing the numerals in the top right corner or scrolling up or down.

Microwave Ovens

Refer to the Certified Performance Checkout sheet, included in your owner's packet, for manufacturer, model, and serial number information.

Monitor Panel

The monitor panel inside the galley cabinet gathers data that is accessed and viewed on the Multiplex System display, [see Multiplex System on page 5-16](#), and the MyAirstream app. The monitor panel requires no input but remains functional and can be used should the need arise. Refer to the instructions that follow to operate the panel.

Tank levels are monitored by sender pads mounted on the sides of each tank. Data from each sender pad is transmitted to the display through a single two-conductor wire. When a button for a particular tank is pressed, the display powers up to show the current level. The display also indicates the battery voltage when the BATT button is pushed.

Viewing Tank Levels

Press and release the button corresponding to the tank to be checked, and the display will show the levels in percent on the LED display. If no other button is pressed, then the display shuts off after about 5 seconds.

If another button (including BATT) is pressed before the 5-second time is up for the first button, the display will immediately switch to show the new level or voltage. The 5-second time-out is restarted every time a button is pressed.

To continuously display a reading, press and release the desired button, then press the same button again. The display will be on hold mode when the button is released, indicated by the decimal point on the right-hand side. While the display is in hold mode, it will recheck the level once per second so the user can watch the level change while the tank is filled or drained. The display will automatically shut off after 5 minutes in hold mode. To end the hold mode before the 5 minutes is up, press any tank button, and the display will shut off. By pushing two buttons at once, the diagnostic functions can be accessed.

Viewing Battery Voltage

Press the BATT button and release it; the display will show the battery voltage on the LED display. The display will shut down after about 5 seconds if no other button is pressed.

If the BATT button is held down, the display continuously rechecks the voltage and shows the updated value. The reading may flicker back and forth between two values.

If another button is pressed before the 5-second time is up for the BATT button, the display will immediately switch to show the value for the new button. The 5-second time-out is restarted every time a button is pressed. There is no hold mode for the battery voltage.

Refrigerator

Please review all refrigerator instructions inside your owner's packet (instructions may be left in the refrigerator). When closing the door, listen for a "click" and ensure the door is latched to prevent it from opening during travel. The refrigerator is all-electric and has a 12V compressor; no LPG is required.

The battery disconnect must be on for the refrigerator to operate. To turn the refrigerator on, touch and release the ON/OFF button. The blue indicator light will glow solid blue to indicate that the refrigerator is on. To shut down the fridge, touch and hold the ON/Off button for 5 seconds and release.

To get ready for a trip, start your refrigerator and let it cool for eight hours before loading it with food. For the best cooling performance, let air move freely inside the compartments. The freezer and refrigerator compartments operate independently of each other.

To defrost, turn the refrigerator off and prop open the door. Most of the condensation will run out of the condensate tube to the outside of the trailer. Use dry towels to keep extra condensation from dripping onto the floor. Do not use heat or sharp objects to speed up defrosting, as this can damage the unit.

To decrease the amount of ice that collects on the rear wall and on food, cover all liquids and moist food, and let all hot foods cool before putting them in the refrigerator. Only open the door as long as necessary. The freezer compartment is made to keep pre-frozen food frozen and not to quick freeze food. Ensure the airflow vents are clear and clean for optimal operation.

Clean the interior periodically with mild cleaner or solution of liquid dish detergent and warm water. Rinse with a solution of baking soda and clean water.

NOTICE

Speeding up the defrost process with a knife, scraper, or with heat may cause damage or rupture the refrigerant circuit.

AIRSTREAM®

Section 6 EXTERIOR

CLEANING	6-2	SmartPlug Cable/Satellite and Ethernet Inlet	6-7
Exterior Skin	6-2	Shoreline Power Inlet and Cordset	6-7
Windows	6-2	SmartPlug Inlet	6-7
Aluminum Wheels	6-2	SmartPlug Cordset	6-7
GENERAL INFORMATION AND OPERATION	6-3	Hitch/Coupler	6-8
Main Door	6-3	Axle and Running Gear Assembly	6-8
Keyless Entry	6-3	Nev-R-Lube Drums/Bearings	6-8
Door Hold-Back	6-3	Tire Pressure Monitoring System (TPMS)	6-8
Screen Door	6-3	Power Stabilizing Jacks	6-9
Door Bell	6-3	Power Jack	6-9
Emergency Escape Windows	6-3	Power Jack Blade-Style Circuit Breaker	6-9
Front End Protection	6-4	Manual Operation	6-9
Window Stone Guards	6-4	Liquid Petroleum Gas (LPG)	6-10
Stainless Steel Rock Guards	6-4	Fill Valve	6-10
Step	6-4	Automatic Gas Regulator	6-11
Power Awning	6-5	LPG Tanks	6-11
Locking and Unlocking the Awning	6-5	Exterior LPG Port	6-12
Awning Operation	6-5	Basic Rules For LPG Safety	6-12
Gravity Water Fill	6-6	If You Smell Gas	6-12
City Water Hookup	6-6		
Exterior Shower/Sprayer Port	6-6		
120-Volt Outlet	6-6		

Cleaning

Exterior Skin

We recommend the trailer be washed about every four weeks, and waxed with Walbernize Super Seal or high quality clearcoat-safe wax in the spring and fall. In coastal and industrial areas, cleaning and waxing should be done more frequently. When traveling through winter weather, all road treatment chemicals should be removed immediately.

NOTICE

Abrasive polishes or cleaning solvents such as automatic dishwasher or acid etch cleaners are too strong and should never be used. Rinse all grit from surface prior to washing. Use soft rags or wash mitts, always moving lengthwise with the grain of the trailer (washing or polishing). Never rub hard on the coating. Even the softest rag will damage the coating if excessive pressure is applied.

NOTICE

Always clean your trailer in the shade or on a cloudy day when the aluminum skin is cool.

Oil, grease, dust, and dirt may be removed by washing skin with any mild non-abrasive soap or detergent. Cleaning should be followed by a thorough clean water rinse. Drying the unit with a chamois or a soft cloth may prevent spots and streaks.

After cleaning and drying, a good grade of non-abrasive automotive paste or liquid wax will increase the life of the finish, especially in coastal areas where the finish is exposed to salt air or in polluted industrial areas. It will also protect the shell from minor scratches and make subsequent cleaning easier.

It is important to remove substances such as sap, gum, resin, and asphalt as soon as possible by washing and waxing. Sunlight and time will bake-harden these materials, making them almost impossible to remove without heavy buffing. If asphalt remains on the trailer after washing, use a small amount of kerosene on a rag and wipe the spots individually, being careful not to scratch the finish.

If a substance is found on the coating that cannot be removed by normal washing procedures, Airstream recommends using DX 330 Acryli-Clean, made by PPG Industries. Follow all directions and warnings on the product container.

Acryli-Clean should be used by trained personnel only, using the proper equipment under controlled conditions. Use the Acryli-Clean as sparingly as possible to remove glue, tar, and other similar substance.

To keep your trailer looking new, periodically paint the A-frame, LPG tanks, and rear frame.

It is recommended that the caulking and sealant used in external seams and joints, such as end-shell segments and around window frames, light bezels, beltline, and rub rail molding, etc., be checked once a year. If this material has dried and become cracked or checked, or if a portion has fallen out, it should be replaced with fresh material to prevent possible rain leaks. Caulking and sealing products are available from your Airstream dealer.

Windows

Clean your trailer windows the same way you clean the windows in your home. Clean the seals with a damp cloth and mild detergent every three to six months. Do not use strong solvents, as they will damage the seals. A coat of natural silicone lubricant applied after the seal has dried will keep it flexible. Spread the lubricant evenly with a brush or finger, working it into the surface. This is a good practice for all rubber seals in your trailer.

⚠ WARNING

Failure to properly clean and lubricate the window seals could result in the window sticking to the jamb. Window seals that become stuck to the window jamb should be released by a qualified technician trained in the procedure. Do not force, pry, or apply great pressure to open the window. Failure to heed this warning may cause the window to shatter and/or cause personal injury.

For replacement of a damaged window, contact an Airstream Service Center.

Aluminum Wheels

The aluminum wheels and axle end cover come treated with a clear coating. Keep them looking good by washing with soap and water. Do not use abrasive cleaners or polishes on coated aluminum wheels.

General Information and Operation

Main Door



The orientation of the latch assembly shown above may be inverted on your trailer, depending on the direction the door opens.

⚠ WARNING

BEFORE TOWING

The door handle and deadbolt must both be locked from the exterior using the keys. Never lock them before shutting the door. Failure to fully lock both the handle and deadbolt using the keys in the manner described as follows may result in the door vibrating open during travel.

Close and lock the door from the exterior using the keys in the following order:

1. **DOOR HANDLE:** Insert the ROUND KEY and rotate it counterclockwise until it stops and an audible CLICK is heard; rotate the key back approximately 1/4-turn to the vertical position to remove it.
2. **DEADBOLT:** Insert the SQUARE KEY and rotate it counterclockwise until it stops and an audible CLICK is heard; rotate the key back approximately 1/4-turn to the vertical position to remove it.

Pull on the handle to verify the door is secured.

⚠ WARNING

Never transport passengers inside a trailer. Towing a trailer with passengers inside is unsafe and could result in death or serious injury.

NOTICE

To avoid damaging the door jamb and latch assembly, ensure the deadbolt is retracted before closing the door.

Keyless Entry

The Airstream Classic has a keyless entry door lock that operates the deadbolt only. Keyless entry is a convenience feature that can be used to lock the door when you are away from the trailer. Please secure the door using the keys in the manner described in this section prior to towing. If the key fob becomes misplaced, please contact your Airstream dealer for a replacement.

Door Hold-Back

The main door has a hold-back that secures it to the side of the trailer when the screen door is in use. To use the hold-back, gently push the door into the spring-operated slide to latch it; slide the hold-back to release.

For lubrication and out-of-adjustment issues, see [Main Door Care on page 8-19](#).

Screen Door

The screen door is secured to the main door by a slide bolt-type latch. It can be operated independently by releasing the slide bolt and swinging the screen door away from the main door.

NOTICE

Always reattach the screen door to the main door prior to closing the main door; otherwise, damage may occur.

Door Bell

The Classic is equipped with a door bell system that is powered by 4 C batteries. The door bell is located on the entrance wall. The button to operate the door bell is located right outside the main entrance door.

Emergency Escape Windows

To remove the screen, pull out the screen cord by the cord loop at the bottom portion of the window. Turn the two red latches inward and lift the two red arms on each side, in unison, to open the window and push it out for clearance.

Front End Protection

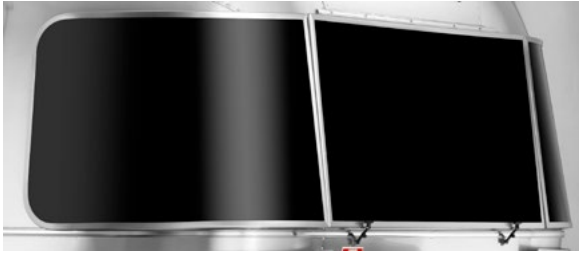

Window Stone Guards

The tinted solar plexiglass window stone guards on the front of your Airstream provide added protection from road debris while traveling and reduce the effects of sun rays.

Raise the center window guard to allow air to flow when the window is open. To raise, unhook the two rubber T-handles on the bottom of the guard, lift the guard to the desired height, and tighten the thumbscrews on each support arm. Be sure to lower and fasten the guard when high winds are approaching and before travel.

The corner window guards are removable for cleaning. Airstream recommends removing the corner guards from the unit when cleaning to avoid damaging the guards. There are two screws on each corner guard near the center guard. A quarter-turn will loosen the screws, and the guards will swing outward on their hinges. Lift the guards off the hinges to remove them.

NOTICE

Close window guards before high winds and storm conditions approach, or when towing to avoid damage to the trailer and window guards that cannot be covered by warranty.

Stainless Steel Rock Guards



Stainless steel rock guards protect the front end from road debris. You can clean behind the rock guards by swinging them forward on their hinges. They are locked in place with two acorn-style nuts, removable with a 7/16" wrench.

Step



To operate the step, lift up on the front of the step and pull straight out until step locks into place. After extending step, the second portion folds out. To store the step, fold it back into position, lift the front slightly, and push the step back into its storage area.

WARNING

Never enter the trailer without lowering the steps. Always check that the steps are down before stepping out of the trailer. Once the steps are lowered, press down on them to make sure they are secure in their notches. Never travel with step lowered or extended.

Power Awning

The patio awning's primary function is sun protection; while it is water-repellent, it is not intended for use as a rain shelter. The awning should be retracted during extended periods of rain, heavy rain, stronger winds, or snow. Operating instructions have been provided with your power awning.

Clear tape is placed between the exterior skin and the awning fabric to prevent the awning fabric from rubbing on the coating and wearing it through; have it replaced if it begins to wear thin.

Locking and Unlocking the Awning

The power awning will automatically LOCK if the travel trailer is plugged into a tow vehicle through the 7-way plug and the tow vehicle's brake pedal is pressed.

To UNLOCK the awning, press and hold both awning tilt pushbuttons on the control panel inside the main entry door. The pushbutton lights will briefly illuminate, and the awning will be unlocked when the lights go out.

Awning Operation

To operate the awning, you must first unlock it (see above). The awning can be operated using the pushbuttons on the control panel at the main entry door, the multiplex system, or the MyAirstream app. For more information, see [Lighting and Awning Control Screens on page 5-18](#) and see [Control Panel Pushbuttons on page 5-20](#).

When using the app, you will get a pop-up to confirm that you intend for the awning to deploy. Make sure that nothing can impede the deployment of the awning.

⚠ CAUTION

Do not operate the awning without first visually inspecting it to ensure nothing is obstructing its operation and close the main door prior to operating the awning. In addition to the controls described in this section, selecting Away Mode on the Multiplex panel also retracts the awning.

NOTICE

The effects of wind and rain on any awning are unpredictable. If wind or extended periods of rain are expected, retract the awning. Severe damage to the trailer and the awning may result and cannot be covered by warranty.

If the power to the awning has been turned off or interrupted, the entry door must be closed before retracting the awning. When power is interrupted, the awning controller must reestablish its "home" position by completing a "closed/reset cycle." This is a normal procedure whenever power to the awning controller is interrupted.

During the close/reset cycle, the awning arms will fully lower before the awning retracts. If the main entry door is left open during this process, the awning's gas rafter will contact the door, damaging the gas rafter. If you turn off the power to the awning, or if power is lost while it is extended, follow these steps to retract it:

1. Unlock the awning by simultaneously pressing the Tilt Front and Tilt Rear buttons.
2. Close the entry door, press the retract/close button, and wait for the awning to come to a complete stop. The close/reset cycle is a timed process that prohibits the awning from completely closing, protecting it from damage.
3. Press the extend/open button, and when the awning starts to extend, press the retract/close button once to stop the awning.
4. To complete the process, press the retract/close button once again to finish retracting the awning. After the awning has finished closing, the screen should read "Closed." The home position has been restored.

NOTICE

To avoid damaging the entry door, awning, and awning gas rafter after power to the awning has been interrupted, ensure the door is closed before retracting the awning.

Exterior

Gravity Water Fill

The gravity water fill is located on the side of the trailer, behind a locked compartment. It is used to fill the fresh water tank with potable water. A small vent is located next to the port to allow air to expel from the tank as it is filled.

Fill the water tank by inserting a high-pressure RV/ Marine FDA approved drinking water hose of at least ½-in. diameter made from material that is tasteless, odorless, and non-toxic. It's a good idea to let the water run through the hose for a short time to flush it out. RVers sometimes fill their tanks with "home" water to avoid strange water that may be distasteful to them on short outings. Remember, the more water you carry in the fresh water tank, the less cargo carrying capacity you have for other items. The amount of water in the tank may be checked on the Multiplex Control Panel Home Screen.

City Water Hookup



The city water hook-up is located on the side of the trailer. For consistent water flow and plumbing line safety, an in-line regulator limits pressure to 50 psi.

Use a tasteless, odorless, and non-toxic high-pressure hose of at least 1/2 in. diameter designed for RV use. The city water inlet is a standard garden hose thread. We suggest you carry two lengths of hose in order to reach hookups farther away than normal, plus, to have a spare.

After hooking up the hose and turning on the city water valve provided in the park, slowly open a faucet. There will be a lot of spurts and sputtering until all the air is expelled from the trailer system. If the water heater is empty, it will take some time before all the air is expelled and a steady flow of water occurs at the faucet. Once a steady flow is achieved at one faucet, the others should be opened long enough to expel the air in the lines going to them.

Your plumbing system has a built-in pressure regulator to protect your lines and faucets from extremely high pressures on some city water systems.

Exterior Shower/Sprayer Port



Your Airstream is equipped with an exterior shower sprayer port on the roadside exterior. It is advisable to briefly turn off the water pump or external water supply when connecting or disconnecting the provided sprayer hose, as the port may be under pressure.

Push the sprayer hose fitting into the port until the quick-connect engages. To disconnect, press on the quick-connect collar to release the hose.

⚠ CAUTION

The port is under pressure when the water pump is on and when the trailer is connected to a city water supply.

120-Volt Outlet



A 120 volt receptacle is located on the curbside of the travel trailer and is labeled for your convenience. The trailer must be plugged into a shoreline power supply for the outlet to operate.

SmartPlug Cable/Satellite and Ethernet Inlet



Connect any external cable TV provider's coax or portable satellite antenna coax and ethernet internet cable to the SmartPlug Cable/Satellite and Ethernet Inlet (located on the roadside exterior near the Smartplug power inlet).

Shoreline Power Inlet and Cordset



SmartPlug Inlet

Your Airstream is equipped with a SmartPlug power inlet located on the roadside exterior. The multiplex system will detect when a shoreline connection is established; see [Home Screen - Shoreline Detection](#) on page 5-17.

Prior to establishing a connection, review the SmartPlug Cordset instructions that follow.

Features of the SmartPlug include:

- Eliminates Overheating - Increased pin & clip surface area improves conductivity during high demand.
- Ease of Use - The unique plug body shape and push-in design ensure a proper connection.
- Multi-Point Locking System - Side clips lock the plug securely into the inlet, eliminating stress on the pins.
- Weatherproof Seals - Multi-fin silicone gaskets installed in the inlet cover and interior of the plug body eliminate moisture penetration.

SmartPlug Cordset

Before connecting power to your Airstream, plug the cordset (power cord) into the power pedestal and check the cordset's safe/unsafe LED indicator lights. If the red LED illuminates, do not plug the cordset into the SmartPlug inlet on your Airstream.

The cordset has a Reverse Polarity Indicator System with two LED indicator lights, one blue and one red. Reverse polarity occurs when connecting a cordset to a power pedestal that has the positive and negative leads reversed internally. A reverse polarity condition is unsafe, and it can damage an Airstream's electrical components.

Safe/Unsafe LED Signals:

- Blue ON, Red OFF - Normal Power, Safe
- Blue ON, Red ON - L1 and neutral are swapped in a reverse polarity condition, Unsafe
- Blue OFF, Red ON - L1 and ground are swapped in a dangerous reverse polarity condition, Unsafe
- Blue OFF, Red OFF - No Power

Many campgrounds provide less than 30 amp service, and your hookup may blow their fuse or circuit breaker. If this happens, reduce the load, replace the fuse, or reset the breaker.

⚠ WARNING

A reverse polarity condition is detected if the cordset's LED illuminates RED when connected to a power source. If this occurs, do not plug the cord into your Airstream. Reverse polarity is an UNSAFE condition that could result in bodily harm. It can also damage electrical components. This condition exists when the power pedestal is improperly wired.

Hitch/Coupler

The EZ-Latch coupler features a simple-to-use latching mechanism. Hooking up is as easy as dropping the coupler on to your hitch ball. Simply make sure that the coupler is properly lined up with the ball, then lower the coupler. The coupler will automatically open and latch into place when lowered onto the hitch ball. To disengage coupler, pull up on latch and raise coupler off of hitch ball. Return the coupler latch to the latched position to ensure that coupler is ready to be latched again. The coupler features a strong composite handle, If the handle does get damaged or becomes missing, the coupler is still completely operational until the handle can be replaced. Replacement parts can be purchased through your Airstream Dealer. See additional information included in your owner's packet.

Axle and Running Gear Assembly

Each Dexter Torflex® rubber torsion axle is aligned during manufacturing, and double-checked on a random basis. Alignment after delivery is the customer's responsibility.

Hitting chuck holes or rough railroad tracks while traveling straight will only cause misalignment after the tire has struck such objects many times. Of course, a deep enough hole can affect the alignment immediately.

The worst culprit is a curb because they are normally struck at an angle. Rear axles are occasionally damaged when people are attempting to park beside a curb while backing up their trailer.

The trailer axle(s) is bent upward in the middle. This bend is normal and is how the camber is obtained. Also, toe-in is built into the axle by very slight bends in the axle tube on each end.

Tire wear indicates misalignment. Check with your dealer for the nearest location with the proper equipment to correct the trailer's alignment.

For Toe-In and Camber Specifications, [see Toe-In and Camber Specifications on page 8-10](#).

Nev-R-Lube Drums/Bearings

Dexter's Nev-R-Lube bearings are comprised of opposed tapered roller bearing cones sealed inside a precision-ground, one-piece, double-cup arrangement. These bearings are designed with a small amount of axial end-play. The end-play is essential to the longevity of the bearing's service life; [see Axles and Bearings on page 8-9](#).

Tire Pressure Monitoring System (TPMS)

Your Airstream is equipped with a Tire Pressure Monitoring System (TPMS). Tire pressure sensor data is displayed on the multiplex touchscreen, [see Home Screen - Tire Pressure Monitor System on page 5-17](#), and the tow vehicle TPMS display you were provided. A repeater is installed in the trailer to help boost the signal from the tire sensors to the vehicle monitor.

The following paragraphs provide basic information on the features and operation of the tow vehicle display. Please review the TPMS manufacturer's manual for detailed instructions on how to use the tow vehicle display.

To operate the display, slide the switch on the side up to turn it ON and down to turn it OFF. If the display is plugged into a constant 12V source, you must unplug it to turn it off.

All tires, including the spare, have tire sensors. The TPMS tow vehicle display shows real-time tire pressure and temperatures and provides audible and visual alerts. If an alarm sounds, an icon will blink near the bottom of the screen, and the tire in question will blink its pressure or temperature on the display screen. Onscreen text will indicate the issue, such as a fast leak, low pressure, or high temperature. To view a specific tire reading, press the plus or minus button on the monitor's side to scroll through the tire sensors.

Tire pressures will lower in the evening as the ambient air temperatures decrease, which may result in notifications. The tow vehicle display can be turned off when these cold conditions occur until the ambient temperature rises or you begin driving again.

It's important to note that when tires are rotated, the sensor configuration on the tow vehicle monitor and the Multiplex system will need to be updated; [see Updating the TPMS Monitor and Multiplex Link on page 8-8](#).

NOTE

Indoor/outdoor thermometers could interfere with the sensors' signals.

Power Stabilizing Jacks

The Classic trailer is equipped with two sets of power stabilizing jacks. These jacks are controlled by a switch located in the locked utility compartment on the side of the trailer.

NOTE

Power stabilizing jacks automatically adjust to the terrain and should only be lowered until they make contact with the ground.

⚠ CAUTION

Stabilizing jacks are designed to stabilize the trailer only. Misuse of the power jacks to level or lift the trailer will result in damage to the jacks and potentially the trailer.

Power Jack

The power jack is operated using the up/down switch on the power head. When the jack is fully extended or retracted, the internal clutch will activate.

- Use the jack for lifting the trailer only.
- Never get beneath the travel trailer when only the power jack supports it.
- Support the vehicle by appropriate means.

⚠ WARNING

Avoid the risk of injury to yourself and others. Keep hands and feet from under the foot plate when using the jack. Do not use or install dolly wheels on the power jack. Do not operate the toggle switch with the manual crank handle in place. Failure to comply could result in serious injury.

NOTE

When operating the power jack, pause briefly between switching up and down. Rapidly switching from up or down may cause the breaker to trip, momentarily interrupting power to the jack.

Power Jack Blade-Style Circuit Breaker

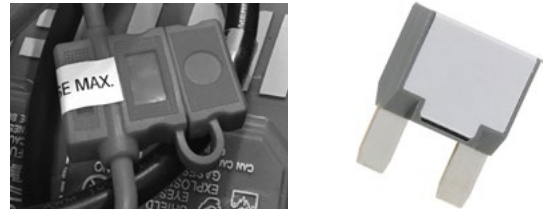

The jack is wired directly to the battery and has an automatically resetting blade-style circuit breaker between the battery and the power head inside the battery box. Should the breaker trip, allow time for it to reset and try operating the jack again. If the breaker does not reset or trips again, the jack may need to be serviced, or the breaker may need to be replaced. Refer to an authorized dealer for service. For maintenance information, [see Power Jack on page 8-11](#). For breaker replacement, [see Replacement Breakers - USA Breakers on page 8-3](#).

Manual Operation

Should an electrical failure occur, the jack can be operated manually by unscrewing the bubble level/cap and placing the manual override handle into the alignment tube to engage the drive pin. Rotate the handle counterclockwise to raise or clockwise to lower the trailer.

Liquid Petroleum Gas (LPG)

Fill Valve



The LPG tanks are equipped with fill valve connections **RV Type / Acme**. The large, green, nylon swivel nut is a right-hand thread and is designed for hand operation only.

The valve features an internal spring-loaded module that will not allow gas to flow from the cylinder until a positive seal has been made at the connection. The valve outlet has 1-5/16 in. Acme threads on the outlet exterior, and female POL fitting; left-handed threads on its interior. This feature allows for connection of the new, wrench less, right-handed, Acme RV connection while still accommodating the standard left-handed POL fittings used for filling propane cylinders.

The mating, green swivel nut and brass nipple also incorporate new features: the green nylon nut swivels on a black bushing that is heat-sensitive. Between 240 and 300°F, the bushing will yield (melt) allowing the spring-loaded module in the valve to push the brass nipple back (approximately 1/4 in.), closing the module and stopping the flow of gas from the cylinder. Inside the brass nipple is a flow-limiting device designed to sense excessive gas flow. If an excessive flow is sensed, the flow-limiting device shuts the flow down to a maximum of 10 SCFH (Standard Cubic Feet per Hour) or less. This is also referred to as the bypass flow.

Bypass flow is extremely important in the proper operation of this connection. The flow-limiting device may activate if the cylinder valve is opened quickly. When all appliances are off, the bypass flow allows the pressure downstream from the flow-limiting device to equalize. When pressure is equalized, the flow-limiting device will supply normal flow to the system. Equalization occurs in approximately 5 seconds and, in most cases, goes completely unnoticed. If, however, an appliance is left on or there is a leak or open flow in the system, the bypass pressure will not be able to equalize and allow the flow-limiting device to re-open. Symptoms of this condition would be appliances that light but have lower than normal flame or starve out from lack of gas, a substantial reduction in the flame when another appliance is operating, or pilots that are difficult to light. If this should happen, the following steps should eliminate the condition:

1. Close LPG cylinder valve.*
2. Extinguish all flames and smoking materials.
3. Be sure all gas appliances, including their pilot lights, are off.*
4. Open LPG cylinder valve slowly. Do not snap open.
5. Wait at least 15 seconds before lighting appliances.
6. If operational difficulties continue, there may be a leak in the system. Immediately close the LPG cylinder valve and have the system inspected by a qualified RV service technician.

*When reconnecting a full cylinder to an auto changeover regulator, it is not necessary to shut off the appliances or close the valve of the cylinder already in service.

The amount of time a full tank of gas will last is dependent on usage. In cold weather, when you are using the furnace, large amounts of hot water, and are doing extensive cooking, you will naturally use more than you will in warm weather when you may do limited cooking. On the average, with normal cooking and other appliance use, you can probably count on two to three weeks of service from each tank.

⚠ DANGER

Leaking LPG may ignite, causing a fire or explosion, which could result in serious bodily injury, property damage, and/or death.

Automatic Gas Regulator

All models are equipped with a two stage automatic change-over gas regulator that offers the convenience of automatic changeover from empty to full gas cylinders. Both tanks are connected to this regulator.

Make sure there is propane in both tanks before you start. Rotate the white knob on the top-front side of the regulator toward the cylinder you want to use first. This will be the **service** cylinder and the other will be the **reserve** cylinder. Slowly open both cylinder valves. Open both cylinder valves completely, then close about 1/4-turn. This will allow you to easily check to see if valves are open or closed. The indicator on top of the regulator will turn bright green. The indicator will stay bright green as long as there is fuel coming from the service cylinder. When the service cylinder empties, the regulator will automatically draw fuel from the reserve cylinder, providing an uninterrupted fuel flow to the system. When it switches over, the indicator will change from green to red. This red color indicates the service cylinder is empty and needs to be filled.

⚠ DANGER

LPG regulators must always be installed with the diaphragm vent facing down. Regulators that are not located in compartments have been equipped with a protective cover. Make sure the regulator vent faces down and the cover is kept in place to minimize vent blockage, which could result in excessive gas pressure, causing fire or explosion.

LPG Tanks

The following procedure outlines the proper method of removing and installing LPG bottles:

1. Turn the knob on your automatic regulator until the arrow points to the tank opposite the one to be removed. Shut off the gas valve on the tank to be removed.
2. Disconnect the rubber gas line at the tank to be removed. (The green plastic fitting is a right-hand thread and no tools should be used.)
3. Turn the large clamping T-handle counterclockwise until the hold-down bracket is loosened enough to be able to remove the tank. If your trailer is equipped with a gas tank cover, the T-handle must be removed, and then the cover removed before removing the bottle

⚠ WARNING

Do not remove the center hold-down rod.

LPG Tank Installation:

1. Place the tanks in position on the A-frame and tank cross-member so that it rests on the upper collar of both tanks with the collar rims engaged in the grooves on the underside of the bracket. If your trailer is equipped with a tank cover, it should be positioned over the tanks next. Make sure the hold-down rod projects up through the hole in the shroud center bracket.
2. Replace the T-handle and tighten down until the tanks are held firmly in place.
3. Test fittings with liquid soap free of ammonia or chlorine, or products designed for testing, such as Snoop® liquid leak detector.

If you have allowed both tanks to run out, air may have gotten into the lines. In this event, the air must be forced out through the lines by gas pressure before you will be able to light the pilots. Hold a match to the pilot of the appliance closest to the tanks until it lights and stays lit. Then move to the next-closest appliance, etc.

⚠ WARNING

Your LPG tanks must be filled as directed by the tank manufacturer. Instructions are located on a decal near the fill valve. The decal must not be defaced.

⚠ WARNING

The LPG tanks are securely mounted on the front A-frame of your trailer. If these tanks must be removed for service or replacement, it is important that they be reinstalled correctly in order to prevent any possibility of their falling off or becoming dislodged during travel.

⚠ WARNING

Use only the LPG tanks furnished with your trailer. If replacement is required, it must be a bottle of the same size and design.

Exterior LPG Port

An exterior LPG port quick-connect is installed on the hitch A-frame of your trailer. An LPG supply line is shipped with the trailer in the loose parts box. This can be used to connect a lantern or other appliance that uses a one-pound, low pressure LPG tank supply to the exterior port.

To assemble, install a male quick-connect coupler to one end of the supply hose. Then add a flare fitting to the other end of the supply hose and install a one-pound tank coupler to the flare fitting. This assembly can be installed into the appliance in place of the one pound LPG tank.

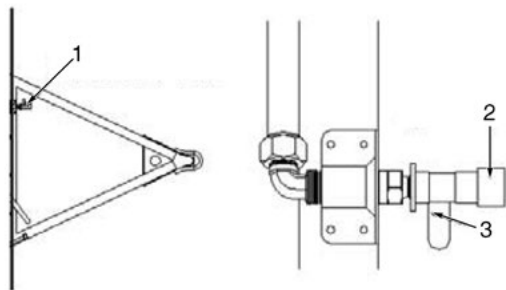

1. Exterior LPG Port
2. Quick-Connect Sleeve
3. Shutoff Lever

Basic Rules For LPG Safety

A warning label is displayed in the cooking area reminding you to provide an adequate supply of fresh air for combustion. The amount of oxygen supply in a trailer is limited due to its compact design. When using the cooking appliances, proper ventilation will prevent dangers of asphyxiation. It is especially important that cooking appliances not be used for comfort heating as the danger of asphyxiation is greater when the appliance is used for long periods of time.

⚠ DANGER

Do not use cooking appliances for comfort heating. Cooking appliances need fresh air for safe operation. Before operation, open an overhead vent or turn on an exhaust fan and open a window.

⚠ DANGER

A warning label has been located near the LPG container. This label reads: DO NOT FILL CONTAINER(S) TO MORE THAN 80 PERCENT OF CAPACITY. Overfilling the LPG container can result in uncontrolled gas flow, which can cause fire or explosion. A properly filled container will contain approximately 80 percent of its volume as LPG.

⚠ DANGER

Do not store LPG tanks within a vehicle. LPG tanks are equipped with safety devices that vent gas should the pressure become excessive.

⚠ DANGER

Portable fuel burning equipment, including wood and charcoal grills and stoves, shall not be used inside the recreational vehicle. The use of this equipment inside the recreational vehicle may cause fires or asphyxiation.

⚠ DANGER

Do not bring or store LPG tanks, gasoline, or other flammable liquids inside the vehicle because a fire or explosion may result.

Twice a year, or after a long storage period, we suggest you take your trailer in for a checkup and cleaning of the gas-operated appliances.

If You Smell Gas

1. Extinguish any open flames, pilot lights, and all smoking materials.
2. Do not touch electrical switches.
3. Shut off the gas supply at the tank valve(s) or gas supply connection.
4. Open doors and other ventilating openings.
5. Leave the area until odor clears.
6. Have the gas system checked and leakage source corrected before using again.

AIRSTREAM®

Section 7 TOWING

TOW VEHICLE	7-2	TOWING	7-5
BRAKES	7-2	Safety	7-5
Electronic Brake Controller	7-2	Securing the Door.	7-5
Proper Electric Brake Use.	7-2	Practice.	7-5
Breakaway Switch.	7-3	General Information	7-6
LOADING	7-3	Tracking Observation	7-6
Weighing Your Trailer	7-4	Cooling System Overload.	7-6
HITCHING UP.	7-4	Downhill and Non-level Driving.	7-6
7-Way Plug	7-5	Off-Road Towing	7-6
Equalizing Hitch Load Distribution	7-5	When Being Passed	7-7
Wireless Observation System	7-5	Passing	7-7
		Backing Up	7-7
		Stopped On a Hill	7-7
		Controlling Sway or Fishtailing	7-8
		Dexter Tow Assist® System	7-9
		Overview.	7-9
		Features	7-9
		Operation	7-9
		Light Module:	7-9
		Bluetooth Adapter and Dexter Smartphone App.	7-10

Tow Vehicle

When buying a new vehicle to tow your trailer, we suggest including towing options offered by most tow vehicle manufacturers. These include such things as a heavy-duty alternator and radiator, heavy-duty springs and shock absorbers, transmission cooler, heavy-duty fan and flasher unit, etc., for the make of the vehicle.

⚠ WARNING

Springs that are too stiff can hinder the action of the weight equalizing hitch and prevent the transfer of weight to the front of the vehicle.

NOTICE

Only use springs heavy enough to support your loaded vehicle (not including trailer). Having a too harsh spring rate on your tow vehicle will only shorten the life of the tow vehicle and trailer, and will cause your trips to be less enjoyable.

Transmissions may be manual or automatic, but an automatic transmission may prolong your tow vehicle's life and generally does a better job of controlling engine loads than does the average driver using a manual shift.

Having adequate power is very important when considering the purchase of a new vehicle or the trailer-towing capability of your present one. Auto dealers are provided with guidelines to use when helping a customer decide on a tow vehicle. Guidelines are not determined solely by the power output of the engine. The gear ratio of the differential is also a very important part of the guideline.

Inspect the tow vehicle's hitch regularly for loose bolts or nuts, cracked welds, loose ball mounts, worn parts, etc.

New trailerists often carry more food and other supplies than really needed. Remember that every item you take along is one more thing to stow and adds weight to the total load you must pull. Consolidate items in shelves, lockers, and in the refrigerator. It is better to have one full and one empty locker, than two half empty ones. Special care must be taken not to overload the front and rear ends of the trailer.

Brakes

All trailers are equipped with Dexter Nev-R-Adjust brakes. Please follow all maintenance procedures in the Dexter user's manual provided in the owner's packet. For important inspection and maintenance requirements of the components discussed in this section, [see Axles and Brakes on page 8-9](#).

Electronic Brake Controller

The trailer brakes are operated by 12-volt current from your tow vehicle and must be hooked up so that you have an integral system with your tow vehicle brakes. To prevent problems and ensure satisfactory braking action, install an electronic controller in line with the brakes in your tow vehicle.

An electronic controller will synchronize the trailer brakes with your tow vehicle brakes. It is designed to apply the trailer brakes with your tow vehicle brakes. Your brake controller should be adjusted to provide for a slight lead of the trailer brakes over the tow vehicle brakes.

⚠ WARNING

Study all material provided with your particular brake control. If you do not understand the information, have the installer explain the information to you or call the manufacturer of the controller.

Proper Electric Brake Use

Proper synchronization of tow vehicle to trailer braking can only be accomplished by road testing. Brake lockup, grab, or harshness is quite often due to lack of synchronization between the tow vehicle and the trailer being towed, a too-high threshold voltage (over 2 volts), or under-adjusted brakes.

⚠ WARNING

Never use your tow vehicle or trailer brakes alone to stop the combined load.

⚠ WARNING

The braking system should be checked and serviced by qualified, certified technicians only. Failure to do so could result in loss of control of your vehicle or the trailer, causing damage to property, injury, and/or death.

Breakaway Switch

In the event of an accidental separation of the tow vehicle and the trailer, the breakaway switch will set and lock the trailer brakes for a sufficient length of time to stop the trailer. The switch is activated when the wire attached to it and to the tow vehicle pulls out the small pin in the front of the unit.

When the trailer is connected to the tow vehicle, the breakaway switch loop should be attached to the permanent frame of your hitch. When disconnecting the trailer from the tow vehicle, remove the wire loop from the frame. Do not remove the pin from the switch because this will apply the trailer brakes.

⚠ WARNING

Do not use the breakaway switch as a parking brake. If the battery should go dead, the trailer parking brake would no longer be applied. Failure to comply could cause damage to property, injury, and/or death.

Loading

When towing a trailer, you are subject to new and different challenges on the highway than you may have previously encountered. Towing a trailer is no small responsibility and should be undertaken with great care and safety first in mind. An accident with a tow vehicle and trailer can have much greater consequences than carelessness with a small car. Like an airline pilot who is responsible for expensive equipment and many lives, you should take your responsibilities as a tow vehicle driver very seriously and learn all you can about doing the job safely and well. Balancing the load and preparing the trailer and tow vehicle are critical to safe handling.

One of the most critical aspects of safely towing a trailer is knowing the weights involved and where they are placed. The first thing to determine is how much is being towed and confirming that it is within the capacities of the equipment being used. Determining where the load is placed is critical to the way your rig will handle on the road.

Know what your trailer weighs loaded. Load your trailer including water, propane, etc and take it to a public scales. Weigh each axle of your vehicle. Refer to your axle weight and tire limits to see if you are within a safe range; [see Specifications on page 4-4](#). Total all axle weights, ensuring you are below the Gross Vehicle Weight Rating (GVWR).

Make sure your load is balanced. Do not load too much on one side. A balanced load is much easier to tow or drive. Front to back balance is also important. Step back and look at your trailer, making sure that there is not too much weight on the hitch, or on the rear of the trailer. Secure all items, as loose items can cause damage and become a safety issue. The Cargo Carrying Capacity tag shown below is installed on every trailer and can be found on the inside of the screen door on your trailer.

RECREATIONAL VEHICLE TRAILER CARGO CARRYING CAPACITY
VIN #####
THE WEIGHT OF CARGO SHOULD NEVER EXCEED
XXX kg or XXX lbs
CAUTION
A full load of water equals XXX kg or XXX lbs of cargo @ 1 kg/L (8.3 lb/gal)

Airstream weighs the trailer as finished to arrive at the trailer's weight. That number is subtracted from the GVWR of the trailer and listed under THE WEIGHT OF CARGO SHOULD NEVER EXCEED on the tag. The total weight of any and all cargo, including dealer modifications or additions, water, and propane should never exceed the number listed.

As cargo is added, removed, or shifts in location, the weight on the axle(s) and hitch will change. Also, the hitch and axle weights will change as a consequence of the weight of the LP tank(s) diminishing from use of propane, and/or the transfer of weight as a consequence of water in the fresh water tank being used and transferred to the holding tanks. In shorter units, rear bath models especially, when the LP tanks are empty and fresh water has been transferred to the holding tanks, the reduction in hitch weight may be significant. For this reason, we recommend that the holding tanks be emptied before traveling.

When loading the trailer, keep the following in mind:

- GVWR
- GAWR
- Tire Weight Rating
- Cargo

⚠ WARNING

Never exceed these critical weight limits/ratings. Your safety depends on not overlooking the trailer, axles, and tires.

Towing

Weighing Your Trailer

The illustration below shows how to weigh the trailer on scales.

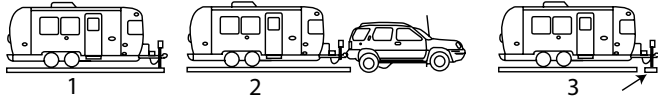

1. Trailer's total weight, cannot exceed GVWR.
2. Trailer's weight on axles cannot exceed GAWR.
3. Weight on trailer tongue.

To determine that the GAWR is not exceeded, it is necessary to load all of your allowable personal cargo and variable weights. Then hitch the trailer to the tow vehicle with load equalizing hitch properly adjusted.

Chock wheels and place the trailer on a scale with both axles only on the scale (see illustration). If the weight on the axles exceeds the axle system's GAWR, then some of the personal cargo must be redistributed forward in order to place some of this weight on the tongue.

The tongue weight should be 10 to 15% of the trailer's total weight, and must not exceed the tow vehicle's or the hitch's maximum weight rating. To determine tongue load, unhitch tow vehicle and place the tongue hitch post on a scale. The trailer must be properly loaded as determined above, with your allowable personal cargo and variable weights.

Use a scale, such as a bathroom scale, that has a lower weight limit than your tongue load to check the tongue weight by using the following method (see illustration).

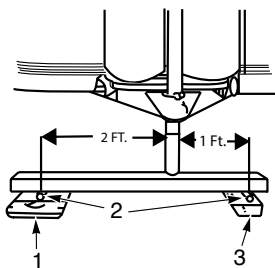

1. Bathroom Scale
2. Pipe
3. Wood Support

Place a piece of wood of approximately the same thickness as the bathroom scales on the ground in line with the trailer hitch jack as shown. It should be so spaced that a short piece of pipe or other round piece will lay exactly one foot from the centerline of the jack extension.

Place the scales so that another round piece can be exactly two feet from the centerline of the jack extension in the other direction. Place a 4x4 piece of wood on the two round pieces and screw the jack extension down on the top of the 4x4 until the tongue of the trailer is supported by it. Multiply the scale reading by three. This will be the tongue weight of your trailer. If you exceed the capacity of the bathroom scales, increase the two-foot dimension to three or four more feet, but always multiply the scale reading by the total number of feet between the wood and scales.

NOTE

Be sure trailer is level when reading scales.

Hitching Up

The process of hitching up your trailer is something that will become almost second nature with practice. The following section includes proper hitch load distribution. Proper training on connecting your trailer to a tow vehicle is essential for safety. Please see your dealer or other qualified personnel for instruction on the proper hitching of your trailer. Safety chain use on the hitch is required in all states.

WARNING

Always make sure coupler is properly attached and latched before towing, and that safety chains are properly attached. Safety chain use on the hitch is required in all states.

7-Way Plug

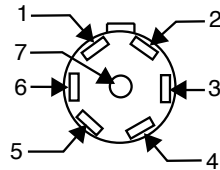

1. Black, 12-Volt (+)
2. Green, Clearance Lights/Taillights
3. Red, Left Turn/Stop
4. White, 12-Volt (-)
5. Blue, Brake
6. Brown, Right Turn/Stop
7. Blank

NOTE

The 7-Way Plug is spliced to the main harness in the area of the 12-volt distribution panel in front of the trailer.

Equalizing Hitch Load Distribution

When a trailer is properly hitched up to a tow vehicle with a load equalizing hitch, approximately 1/3 of the trailer's tongue weight will be on the trailer's axles and 2/3 will be transferred to the tow vehicle. One third of this weight transfer will be carried by the front wheels and 1/3 by the rear wheels of the tow vehicle (See illustration). Thus, the tire load of each wheel on the tow vehicle will be increased by 1/6 of the trailer's tongue weight. The tire air pressure of the tow vehicle should be increased to compensate for this additional weight. Refer to the vehicle's owner's manual for this information.

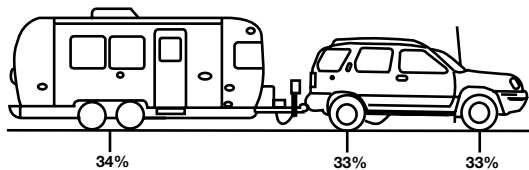

WARNING

The tongue weight should be approximately 10 to 15% of the trailer's total weight. Under no condition should it exceed the tow vehicles hitch rating. Please refer to the tow vehicles documentation for your vehicles hitch rating information.

Wireless Observation System

Your travel trailer is equipped with a Wireless Observation system consisting of a camera mounted at the rear of the trailer and a wireless monitor for your tow vehicle. This system will allow you to see what is behind you while towing and provide visibility when backing up the trailer.

WARNING

Carefully read and understand all manufacturer's instructions provided in your owner's packet prior to operating.

Towing

Safety

The transporting of people in the trailer puts their lives at risk and may be illegal. The trailer does not have seat belts, therefore, it is not designed to carry passengers.

WARNING

Never transport passengers inside a trailer. Towing a trailer with passengers inside is unsafe and could result in death or serious injury.

Securing the Door

Before towing your travel trailer, secure the main door by locking both the door handle and deadbolt from the exterior using the keys. For instructions on how to properly lock the door, see [Main Door on page 6-3](#).

WARNING

BEFORE TOWING

The door handle and deadbolt must both be locked from the exterior using the keys. Never lock them before shutting the door. Failure to fully lock both the handle and deadbolt using the keys may result in the door vibrating open during travel.

Practice

We want every Airstream owner to be a safe and courteous driver. A few hours of towing practice in a large, empty parking lot will make pulling your trailer over the road much easier. Mark off two corners of the parking lot for left and right turns. These corners may also be used to practice backing and parking.

Towing

General Information

After thoroughly inspecting your hitch, brakes, and tires, you should be ready to tow. Check traffic, signal when you are about to pull away, and start slowly. Look often in your mirrors, and observe the action of the trailer, then carefully move into the proper lane of traffic. Remember that the trailer wheels will not follow the path of the tow vehicle wheels, therefore, wider turns are necessary when turning to the left or to the right.

⚠ WARNING

Truck or trailer type fender, door grip, and rear view mirrors are a must for maximum visibility and required by law in most states.

Tracking Observation

Observe that the tracks made by the trailer wheels are distinctly different from those made by the tow vehicle. Studying this will make it easier for you to correct mistakes.

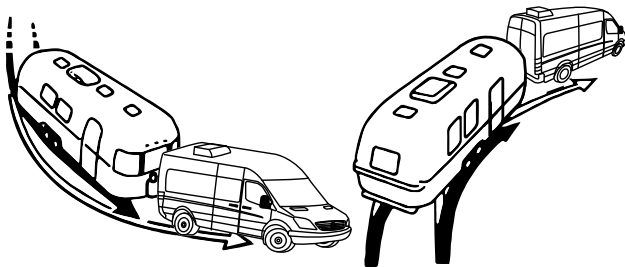

Cooling System Overload

When towing, you might encounter a temporary cooling system overload during severe conditions, such as:

- Hot days when pulling on a long grade
- When slowing down after higher speed driving
- Driving with long, idle periods in traffic jams

If the tow vehicle's temperature gauge or indicator light indicates overheating, and the air conditioner is on, turn it off, pull over in a safe place, and apply the emergency brake. Increase the engine idle speed. Lift the engine hood and check for fluid leaks at the radiator overflow outlet. Ensure that all drive belts are intact and the radiator fan is turning. If you have a problem, have it fixed at the next opportunity. If there is no problem, the light should go off, or temperature should come down within one minute. Proceed on the highway a little slower, and resume normal driving after 10 minutes.

⚠ CAUTION

Never open a radiator cap when the tow vehicle is hot. Check the coolant level when the vehicle is cool.

Downhill and Non-level Driving

When going downhill in dry weather, downshift so that engine compression will slow the whole rig down. Take dips and depressions in the road slowly and do not resume normal driving speeds until you are sure that the trailer wheels are clear of the dip.

⚠ WARNING

On slippery pavement, do not use engine drag to help slow down as this may cause the rear wheels of the tow vehicle to skid. On icy pavement, drive slowly and, if you feel the tow vehicle skidding, gently apply the trailer brakes only. This will bring the tow vehicle and trailer back into a single line. Chains do not help trailer wheels.

Off-Road Towing

When driving in mud and sand, let the momentum carry the rig through. Apply power gently and use as little as possible. Stay in the tracks of the vehicle ahead and keep the tow vehicle in the highest possible gear. If you get stuck, it is best to tow out the entire rig together without unhitching.

When Being Passed

Despite the best hitch, you will notice that whenever a large bus or truck overtakes your rig, the displaced air first pushes the trailer rear slightly to the right and then affects the front. It may be necessary to steer very slightly, momentarily, toward the bus or truck to help compensate for the sway induced by the passing vehicle. Do not apply the vehicle brakes, as this can tend to exaggerate the situation. You may find, however, that briefly applying the trailer brakes with your manual control will help eliminate sway.

On a two-lane road, cars may line up behind you because you travel at a lower speed. It is both courteous and sensible, if you are able, to signal, pull onto the shoulder, and let them pass. Your trailer is designed to be towed easily at any legal speed, so if you are not careful, you may be inclined to forget it is there.

Passing

On freeways or expressways, pick the lane you want and try to stay in it. Always maintain plenty of space between you and the car ahead, at least the length of the tow vehicle plus trailer, for every ten miles per hour. Remember that in order to pass another vehicle, you will need longer to accelerate. You must also allow for the length of the trailer when returning to the right hand lane.

Backing Up

When backing up, the important thing to remember is to do everything slowly and to immediately correct if you see the trailer turning the wrong way. Concentrate on the rear of the trailer. With your tow vehicle and trailer in a straight line, back up slowly and turn the bottom of the steering wheel in the direction you want the trailer to go. Watch out of the window or in the mirror until the rear of the trailer is pointing in the desired direction. Your tow vehicle will be following the trailer in an arc. Straighten the tow vehicle and trailer by turning the steering wheel more sharply, and then, when they are in line, straighten the steering wheel.

Always try to back to your left because the visibility is much better. When you don't make it on the first try, it is usually much easier to pull forward to your original position and start over, or at least pull forward until the rig is straight, and then start backing.

If your spouse or traveling companion normally directs you when backing, they should position themselves forward of the tow vehicle so the driver can easily see them. Their directions should always indicate to the driver the direction the rear of the trailer should go. A little practice in a parking lot with the person giving directions can save a lot of frustration when backing into a campsite.

Stopped On a Hill

Refer to the following warning if stopped on a hill for a prolonged period of time.

⚠ WARNING

Chock the trailer wheels when stopping on a hill or slope. Leaving your tow vehicle in gear is not enough for standstill safety. Do not use trailer brakes as parking brakes.

Controlling Sway or Fishtailing

Sway or fishtailing is the sideways action of a trailer caused by external forces. It is common for travel trailers to sway in response to strong winds, crosswinds, when passed by or passing a semi-tractor and trailer, or driving downhill.

⚠ WARNING

Excessive sway or fishtailing of your travel trailer can lead to the rollover of the trailer and tow vehicle. Serious injury or death can occur. It is important that you read and understand the information in this section.

Sway or fishtailing of your recreation vehicle can be controlled and is primarily impacted by four factors: equipment, tongue weight, driving, and corrective measures:

1. Equipment

When hitched together, the trailer and the tow vehicle must be level. The tires of both the trailer and tow vehicle should be in good condition and properly inflated to their recommended pressures.

Braking is a very important factor in vehicle control; see [Brakes on page 7-2](#) and see [Electronic Brake Controller on page 7-2](#).

2. Tongue weight

For information about tongue weight, see [Weighing Your Trailer on page 7-4](#) and see [Equalizing Hitch Load Distribution on page 7-5](#).

3. Driving

This is the most important component. The tendency for the vehicle to sway increases with speed therefore, obey all speed limits and reduce speed during inclement weather or windy conditions.

4. Corrective Measures

Your trailer has Tow Assist; see [Dexter Tow Assist® System on page 7-9](#). Tow Assist actively works to intervene and mitigate trailer sway, however, should the system have a fault, or if sway occurs, the following techniques can be used:

1. Slow down immediately, remove your foot from the accelerator. Avoid using the tow vehicle brakes unless there is a danger of collision. Reduce speed gradually whenever possible. If you can do so safely, use the brake hand controller to gently and progressively apply the trailer brakes. This will help to keep the vehicles aligned. Practice using the brake hand controller on a deserted parking lot. Do not wait until an emergency occurs before using it. Location of the brake hand controller is important and should be made easily accessible.
2. Steer as little as possible while maintaining control of the vehicle. Because of natural reaction lag time, quick steering movements to counter trailer sway will actually cause increased sway and loss of control. Keep both hands on the wheel. Hold the wheel as straight as possible until stability is regained.
3. Do not jam on the brakes or attempt to press on the accelerator to speed your way out of the fishtailing. Both actions make the situation worse and could cause severe injury or death.
4. Once the swaying is under control, stop as soon as possible. Check tire pressures, cargo weight distribution, and look for any signs of mechanical failure. Travel at reduced speeds that permit full control until the problem can be identified and corrected.

Dexter Tow Assist® System

Overview

 Your Airstream has a Dexter Tow Assist - ABS and Sway Mitigation System that works in collaboration with your tow vehicle's brake controller to improve the safety and stability of trailer braking. Much of the following is excerpted from Dexter's manual and serves only as an overview of the system's basic function and operation. It is essential to read the Dexter manual in your Owner's Packet to become familiar with all system operating instructions, monitoring, and troubleshooting.

For more information, scan the QR code above or visit <https://www.dexteraxle.com/>.

⚠ WARNING

Your Airstream Owner's Packet includes a manual for the Tow Assist System. It is important to read the manufacturer's operating instructions before towing and to follow all safety notifications provided by the manufacturer.

Features

The system features an anti-lock braking system (ABS), trailer sway mitigation (TSM), lane change control (LCC), and trailer brake monitoring. The Dexter manual provides details on each function.

System components and wiring harnesses are mounted throughout your Airstream. The Dexter Brake Control Module or Electronic Control Unit (ECU) is mounted near the axle behind a galvanized steel protective cover under the trailer.

The light module (mounted on your Airstream's roadside exterior) uses light signals to communicate system status information to the driver, which is visible in the driver's side mirror. The Dexter Bluetooth Low Energy (BLE) communication adapter is mounted inside the trailer near the 12V distribution box, and each wheel has speed sensors mounted at the wheel hub.

⚠ WARNING

Dexter Tow Assist system components should only be serviced by qualified technicians trained to service these components.

Operation

Primary trailer braking control remains the responsibility of the vehicle driver and electric brake controller. The Tow Assist system aims to improve the safety and stability of trailer braking while also ensuring that trailer braking efficiency or reliability is not reduced. Tow Assist will intervene when it determines braking safety is compromised, and the system can improve the situation. Please note that, if the Tow Assist system has a fault or loses power, the trailer brakes will still function and provide braking.

The Tow Assist system requires a 7-way tow vehicle connection to function correctly; see [7-Way Plug on page 7-5](#). System startup occurs when power is applied through the 7-way plug connection. Audible clicking may be heard from the Tow Assist ECU performing a self-check. The light will flash briefly as part of the self-check.

After startup, the Tow Assist light will remain off until a valid brake signal is detected. Normal operation will commence when the system detects a brake signal, and the system status will be displayed on the light module. A brake signal is generated by the driver pressing the brake pedal or the brake override lever of the electric trailer brake control. Sway mitigation will only activate at speeds above 40MPH.

Light Module:



The light module mounted on the roadside exterior of your Airstream provides system status information visible in the driver's side mirror. At startup the indicator light identifies to the user that the system is functioning properly with a green light. The green light will remain on at all times while powered, but will transition to a "dim" mode following startup. The green light will intensify when either an ABS or sway event occurs. This does not require any action by the driver, but in effect notifies the driver the system functioned.

Towing

The amber light is used to notify the driver of a potential diagnostic code in the system. The following are basic light signal color and illumination intensity indications. Reading Dexter's manual before towing is essential to understanding what various light indications mean and how they affect system function.

NO LIGHT: indicates that the system has no power or has gone into sleep mode.

LOW-INTENSITY GREEN ONLY: indicates that the system is in full operation and a brake signal has been detected.

BRIGHT-GREEN ONLY: indicates the system is operating and that an anti-lock braking system (ABS), trailer sway mitigation (TSM), or lane change control (LCC) event is occurring. No driver action beyond normal towing and braking is required. The light will return to low intensity about 3 seconds after the event concludes.

ALL OTHER LIGHT COMBINATIONS: If any light combination other than green-only illuminates, refer to the Dexter app [not while driving], the Dexter owner's manual, or both to troubleshoot and determine the meaning of the green/amber or amber-only light signal(s). An amber-only light means a system fault has occurred, and the system is shut down. Regular braking is still available. Tow Assist will not operate in this state.

Tow Assist will turn off the light module illumination after 20 minutes of trailer standstill without a braking signal detected. Tow Assist will go into low-power sleep mode after 120 minutes of trailer standstill without a braking signal detected. Anytime the light module is not illuminated, or illuminates amber-only, the driver must assume the Tow Assist is off or not fully operational.

Bluetooth Adapter and Dexter Smartphone App



Once a connection is established, the Dexter Bluetooth Low Energy (BLE) communication adapter connects to the Dexter app on your smartphone when you are near your trailer. The app has many features, including access to product information, instructions, diagnostics, and the ability to reset the ECU. Refer to the Dexter manual for additional details. To download the app, scan the QR code above, click on one of the icons below from your smartphone, or visit <https://www.dexteraxle.com> for more information.



⚠ WARNING

Never use the app while driving. Distracted driving causes vehicle accidents.

NOTE

The app does not provide real-time live data. Upon opening, the app takes approximately 20 seconds to refresh and provide the latest status information and diagnostic codes.

AIRSTREAM®

Section 8 MAINTENANCE

MAINTENANCE SCHEDULE	8-2	WATER PUMP.	8-11
SUGGESTED MAINTENANCE AND REPLACEMENT PARTS.	8-3	Water Pump Access Locations	8-11
Exterior Care.	8-4	Strainer Cleaning	8-11
TIRES	8-5	Fresh Water Tanks and Draining	8-12
Tire Changing	8-5	Drain Valves	8-12
Jack Location	8-5	Drain Valve Locations.	8-12
Tire Load and Inflation Information	8-6	Opening and Closing Valves	8-12
Proper Tire Inflation	8-6	Fresh Water Tank Draining	8-12
Under Inflated Tires	8-6	Water Heater Draining	8-13
How Overloading Affects Your Tires	8-6	Sanitizing	8-13
Weighing Your Trailer Or Towed Vehicle	8-6	DRAIN AND WASTE SYSTEM	8-14
Tire Care	8-6	Emptying the Holding Tanks	8-15
Tire Care Tips	8-7	Extended Stays.	8-15
Tire Inspection and Storage	8-7	Waste Tank Flush	8-15
Tire and Wheel Replacement	8-7	Drain System Cleaning	8-15
Choosing a Tire	8-7	WINTERIZING AND STORAGE	8-16
Max Load Single vs. Max Load Dual	8-8	Winterization Procedure	8-16
Updating the TPMS Monitor and Multiplex Link	8-8	Restoring Service After Winter	8-18
Lug Nut Torquing	8-9	HEATING AND HOT WATER SYSTEM	8-18
Spare Tire Carrier	8-9	Checking Glycol Levels	8-18
Tire Rotation	8-9	Maintaining the Water Tank Air Cushion	8-18
AXLES AND BRAKES.	8-9	MAIN DOOR CARE.	8-19
Axles and Bearings	8-9	Lubrication	8-19
Nev-R-Lube Drums/Bearings	8-10	Adjustment	8-19
Nev-R-Lube Bearing Inspection	8-10	WINDOWS	8-19
Brakes	8-10	Sticking Windows	8-19
Breakaway Switch.	8-10	ELECTRICAL DIAGRAMS	8-20
POWER JACK.	8-11	12-Volt Main Schematic	8-20
Power Jack Maintenance	8-11	120-Volt/50-Amp Diagrams	8-21
		Solar Panel Wiring	8-27
		FRESH WATER LAYOUTS	8-28
		FAQS AND ANSWERS	8-31

Maintenance

Maintenance Schedule

⚠ WARNING

Failure to maintain your trailer can cause premature and unexpected parts breakage and/or erratic operation that may be hazardous.

NOTICE

See appliance manufacturer's literature for further information.

Every 14 days of Alde System Use

Hot water tank air cushion	Maintain/restore air cushion; see Maintaining the Water Tank Air Cushion on page 8-18 .
----------------------------	---------------------------------------------------------------------------------------------------------

Every 1,000 miles or 60 days

Escape Window	Check operation of latches and upper hinge.
Smoke Alarm & CO Detector	Test and replace battery as required.
Tires	Check tire pressure; see Specifications on page 4-4 .
Hitch	Check for loose bolts or unusual wear.
GFI Circuit Breaker	Test and record.
Shower Door Sweep/Seal	Inspect/clean/replace as needed; see Shower Door Sweep/Seal on page 5-4

Every 5,000 miles or 90 days

Main Door Latch	Lubricate with dry graphite
Exterior Door Locks	Lubricate with dry graphite.
Exterior Hinges	Lubricate with light household oil.
LPG Hold-Down	Lubricate with light household oil.
LPG Regulator	Check bottom vent for obstructions.
Wheel Lug Nuts	Torque to specifications; see Specifications on page 4-4 .
Breakaway Switch	Pull pin and lubricate with household oil, see Breakaway Switch on page 8-10 .
7-Way Plug	Spray with contact cleaner.
Hitch Ball	Lubricate with hitch ball lube or wheel bearing grease.

Every 5,000 miles or 90 days, continued

Range Exhaust Hood	Clean fan blades and wash filter.
Main Door Step	Lubricate and inspect moving parts.

Every 10,000 miles or 6 months

Tires	Inspect and rotate.
Nev-R-Lube	Visually inspect wheel bearings at tire rotation. Refer to Dexter's recommendation www.dexteraxle.com or call (574) 295-7888.
Spare Tire Carrier	Lubricate moving parts.
Windows, and Door Seals	Clean with mild detergent and apply 303 Aerospace Protectant.
Exterior	Wax.
Escape Window	Lubricate latches with silicone grease every 6 months or as needed.

Every 12,000 miles or every year

Brakes	Inspect or replace as necessary every year or 12,000 miles; see Brakes on page 8-10 .
Batteries	Check terminals are secured.
LPG Tanks	Have purged by LPG supplier every year.
Seams	Check and reseal exterior seams, windows, lights, and vents as needed.
Hitch Coupler and Ball	Ensure all parts operate freely. Replace any component if worn or damaged.
Interior Cabinetry	Visual Inspection of latches Locks, Hinges and Slides. Silicone Spray as needed.
Power Jack	Inspect and lubricate; see Power Jack on page 8-11

Every 2 years

Alde Glycol fluid	Drain and replace. Use only Glycol recommended by Alde.
-------------------	---------------------------------------------------------

Suggested Maintenance and Replacement Parts

Part numbers listed are Airstream part numbers and can be ordered by calling a Certified Airstream Dealer.

⚠ WARNING

Always replace the bulb or light fixture with the correct bulb for that light or matching fixture. Failure to heed this warning could cause fire, property damage, personal injury, or death.

Exterior 12-Volt Lighting

License Plate LED	PN – 514065-01
LED Clearance Light, Amber	PN – 512859
LED Clearance Light, Red	PN – 512860
LED Step Light Bulb	PN – 512490
LED Flex Light Strip	PN – 512918-02
Convenience Light (Dump Valve)	PN – 513752

NOTE: Most Exterior Lighting is LED and a replacement fixture will be required.

Interior 12-Volt Lighting

LED Eyeball Light	PN – 513200
LED Light w/Switch	PN – 513707
LED Spot Light w/Frosted Lens	PN – 513136
LED Ceiling Light	PN – 512830
LED Shower Light	PN – 513961
LED Aisle Light, Motion Activated	PN – 513070
LED Light Bar, Surface Mount	PN – 513160
Courtesy Light w/Push Lens	PN – 512829

NOTE: Most Interior Lighting is LED and a replacement fixture will be required.

Replacement Fuses

1 Amp Blade Fuse	PN – 500773-01
15 Amp Blade Fuse	PN – 500773-15
20 Amp Blade Fuse	PN – 500773-20
30 Amp Blade Fuse	PN – 500773-30

Replacement Breakers - USA Breakers

Breaker, Blade-Style, 30A (Power Jack)	PN – 514198-01
Breaker, Bryant, 20 Amp	PN – 510564-01
Breaker, Bryant, 15-15 Amp	PN – 510564-03
Breaker, Bryant, 15 GFCI Amp	PN – 510564-07
Breaker, Bryant, 15 Amp	PN – 510564-09
Breaker, 12V DC Type II, 20 Amp	PN – 510947-20
Breaker, 12V DC Type II, 30 Amp	PN – 510947-30
Breaker, 12V DC Type II, 50 Amp	PN – 510947-50

Replacement Rivets						
	Interior		Exterior		Underbelly	
Part Number	330127-05	330127-08	330126-03	330126-04	330034-100	330038
Rivet Name	AD45ABS	AD48ABS	SSD44SSBS	SSD45SSBS	AD68ABSLF	AD54ABSLF
Head Style	Dome Head	Dome Head	Dome Head	Dome Head	Large Flange	Large Flange
Body Diameter (Inches)	0.125 (1/8)	0.125 (1/8)	0.125 (1/8)	0.125 (1/8)	0.187 (3/16)	0.156 (5/32)
Hole Size	0.129-0.133	0.129-0.133	0.129-0.133	0.129-0.133	0.192-0.196	0.160-0.164
Drill Number	30	30	30	30	11	20
Grip Range In (Inches)	0.251-0.312	0.376-0.500	0.188-0.250	0.251-0.312	0.376-0.500	0.126-0.250
Length Under Head (Max. Inches)	0.453	0.640	0.400	0.438	0.690	0.415
Head Diameter (Nominal)	0.250	0.250	0.250	0.250	0.625	0.468
Head Height (Max. Inches)	0.040	0.040	0.040	0.040	0.092	0.075
Typical Sheer Strength (lb.)*	155	155	520	520	85	225
Typical Tensile Strength (lb.)*	235	235	600	600	135	350

*Values shown are a guide only and may vary depending upon the application.

Replacement Filters	
Range Hood	PN – 512210-100
Merv 8 Return Grill Filter	PN – 382766-01
Merv 8 Filter Sponge	PN – 382766-02

Glycol	
Alde Glycol (1 Gallon)	PN – 360371-301C
Alde Glycol (5 Gallons)	PN – 360371-201C

Interior Touch-up	
Seamfil, Crisp Linen	PN – 360301-37
Seamfil, Planked Coffee	PN – 360301-41
Seamfil, Tuscan Gray	PN – 360301-42
Fil-Stik, Planked Coffee	PN – 360406-21
Fil-Stik, Tuscan Gray	PN – 360406-22
Stain Marker, Crisp Linen	PN – 365504-02
Stain Marker, Planked Coffee	PN – 365504-07
Stain Marker, Tuscan Gray	PN – 365504-11

Exterior Care

The following exterior care products are recommended by Airstream. Read and follow label directions. Exterior sealant should be checked and resealed once a year.

Walberize Super Seal (PN - 28433W) - Use on exterior aluminum of trailer; recommend two applications a year.

Acryl-R Seam Sealer (PN - 28430W-01 [16 oz can-Gray]) - Use anywhere a fine bead of Gray sealant is required.

AdSeal Premium Quality Sealant Adhesive (PN - 365330-01 [10 oz tube-White]) - Use anywhere a thicker bead of White sealant is required.

AdSeal Premium Quality Sealant Adhesive (PN - 365330-03 [10 oz tube-Gray]) - Use anywhere a thicker bead of Gray sealant is required.

AdSeal Premium Quality Sealant Adhesive (PN - 365330-04 [10 oz tube-Black]) - Use anywhere a thicker bead of Black sealant is required.

Tires

Your trailer is equipped at the factory with name brand trailer tires. Most Airstream dealers cannot make adjustments to tires. An Airstream or tire dealer that handles that particular brand must do this. If you experience tire problems, contact the nearest dealer.

Tire Changing

To change a tire with a jack, see the label affixed to the underbelly located to the rear of the wheels. This label reads **JACK** with an arrow pointing to a plate riveted to the mainframe rail where the jack head must be placed.

Jack Location



NOTE

Airstream does not supply a jack with the trailer.

Leveling blocks can be used instead of a jack to change a flat tire. Position the leveling block under the trailer's good tire. This will raise the flat tire clear of the ground. All tire and wheel assemblies are balanced at the factory. Be sure to rebalance the tire and wheel assemblies each time a tire is changed.

⚠ WARNING

Do not exceed the maximum speed rating of the tires installed on your trailer. Failure to heed this warning could cause catastrophic tire failure resulting in property damage, personal injury, and/or death. Refer to the Tire Safety Information Addendum in your Owner's packet for more information.

⚠ WARNING

Never attempt to change any tire on the trailer without securely chocking the trailer's remaining wheels. Never position yourself in a manner where a raised trailer can come down on you if it should become dislodged from a jack or ramp.

⚠ WARNING

When removing aluminum-forged wheels from spindle, it is very important to mark them to ensure the wheel is placed in the same position of the drum when reinstalling. If the aluminum-forged wheel is to be mounted on a different drum, it is important to sand all loose corrosion from the mating surfaces.

⚠ WARNING

WHEEL SEPARATION CAN OCCUR

1. **When removing/reinstalling wheels: torque lug nuts at the beginning of the first trip, and at 5, 25, and 50 miles.**
2. **Thereafter, check lug nuts before each trip.**
3. **Following winter storage, check lug nuts before beginning a trip**
4. **Following excessive braking, inspect and torque.**

⚠ WARNING

Use a torque wrench to tighten lug nuts. Tightening by hand or with an impact wrench is not recommended. For lug nut torque values, see [Specifications on page 4-4](#).

In an emergency, remove a flat tire. The independent suspension of the rubber torsion axle allows four- or six-wheeled units to be safely towed on three or five wheels for a short distance (100 miles maximum) and only at a low speed (30 MPH).

Be especially careful when crossing holes or dips in the road. Under these circumstances, it is good practice to set your rear view mirrors so that you can observe your tires at all time.

Tire Load and Inflation Information

Maintaining proper tire inflation pressure is essential for both tire safety and performance.

Proper Tire Inflation

The level of air in your tires affects your vehicle's overall performance. A maximum inflation pressure specification is found on the trailer's exterior on a metal tag riveted to the lower front, roadside of the trailer, as well as on the original equipment tires.

Air pressure should be checked based on the load on each individual tire. Cold Inflation Pressure should be adjusted to handle the maximum tire load, and all tires on the axle should carry the same inflation pressure. *Cold tire inflation pressure* is the tire pressure checked in the morning before you drive more than a few miles, or before rising ambient temperatures or the sun's radiant heat affects it.

Under Inflated Tires

Under inflation brings a higher risk of damage due to road hazards, reduces casing durability, causes a loss in fuel economy, and will result in uneven or irregular tire wear. Severe under inflation brings about an increased risk of tread separation, handling difficulties, and possible tire failure, caused by overheating.

When minimum inflation pressure requirements are not met, tire durability and optimum operating conditions are compromised. Tire inflation pressure should always meet the guidelines for vehicle weight.

Observe the following:

- It may be necessary to inflate your tires at a truck stop or truck service center in order to achieve adequate air pressure for your trailer's needs.
- Only permanent air seal metal valve caps should be used.
- Be safe - if a tire has been run in a 20% under inflated condition, it must be dismantled and inspected by a trained professional. It should not be aired up without a full inspection or without using a safety cage. Use a calibrated gauge. If your tire is rated for higher inflation pressures, a special gauge will be required designed for larger tires.

⚠ WARNING

Due to RISK OF EXPLOSION damaged tires or tires run with more than a 20% underinflation (approximate) must be dismantled, inspected by a qualified technician, and should not be inflated without using a safety cage.

- Do not bleed air from warm tires to reduce pressure buildup.
- Do not inflate tires to cold psi rating beyond rim specifications.

How Overloading Affects Your Tires

Tire pressure is what enables your trailer tire to support loads, thus, overloading can have serious consequences. Too much weight can cause stress on the suspension system components, brake failure, handling and steering problems, irregular tire wear, and possible tire failure. If you discover your tires cannot handle the load, lighten the weight of the load on your tires.

Weighing Your Trailer Or Towed Vehicle

Since a trailer or towed vehicle adds to the load on the tires, it is crucial to properly weigh towed vehicles; [see Loading on page 7-3](#) and [see Weighing Your Trailer on page 7-4](#).

Tire Care

The most important function of tires is to provide traction while moving and grip when steering or stopping. The tires on your trailer are designed for highway use and must be properly maintained in order to maximize tire life, as well to provide a safe mode of transportation.

Tire Care Tips

To reduce the risk of tire failure, we strongly recommend the following:

1. Check the pressure in your tires, including your spare, at least monthly when the tires are cool (after the vehicle has been stopped for three hours and then driven less than one mile). Do not reduce pressure when tires are hot. Use a tire gauge to check pressure and maintain it at the recommended level.
2. Never overload your tires. Heed the maximum load-carrying capability of your tires.
3. Check your tires frequently for scrapes, bulges, separations, cuts, or snags resulting from use. See your tire dealer immediately if any such condition is discovered.
4. Never operate your vehicle in excess of lawful speeds, the maximum speeds justified by driving conditions, or in excess of speeds recommended for the tires you are using.
5. Make every effort to avoid running over objects that may damage the tire through impact or cutting, such as chuck holes, glass, metal, etc.
6. Never drive on smooth tires. Tires should be removed when 2/32 in. of tread depth remains. In most states, it is illegal to drive with less than 2/32 in. remaining tread depth.
7. Park out of the sun whenever possible when in warm climates. In desert regions, use tire covers to prevent ultra violet light deterioration to tires.

Tire Inspection and Storage

Before taking your trailer on a trip or when removing it from an extended storage period, make it a practice to inspect the overall condition of your tires. Check for any type of condition or damage that might result in failure. A thorough check should include both inside and outside sidewalls, tread area and the condition of hardware such as valve stems, valve caps, and wheels. The tread should be checked for any unusual wear, cracking, penetrations, and/or cuts. An uneven wear pattern can indicate misalignment or worn suspension parts.

Since many RVs are used seasonally and sometimes stored for extended times, it is possible that tires will take many years to wear out. Tires, as any rubber product, will age over time. If tires show cracking in the sidewall or tread surfaces that are more than 2/32 in. deep, they should be replaced before your next

trip or vacation. Store your RV in a cool, dry area away from major heat sources and extreme cold. An enclosed storage area is best with no exposure to electromagnetic sources such as generators or transformers. If you must keep your trailer outside, cover your tires from direct sunlight. Take your trailer to your tire dealer for service to check or correct any of these conditions.

Tire and Wheel Replacement

It is possible to replace your tires with a different size, in some instances. If there is a reason to replace your tires with a different size, make sure the following checks are made before the purchase:

- Does the replacement tire have the load capacity that is needed for my trailer and will it fit properly inside the wheel well?
- Will the overall diameter difference affect the braking system?
- Is the increase in air pressure compatible with the maximum rated pressure stamped on the rim?

Most trailers are towed at or near maximum loads during hot weather and then are left idle for months. In normal use, oils in the tire come to the surface during flexing and protect the rubber from ultraviolet light. But when the trailer tires sit idle too long, natural aging may cause the rubber to crack prematurely, especially in the sidewall area. Trailer tires over 5 years old should be inspected by a tire expert for cracking and replaced even if it has no apparent tread wear.

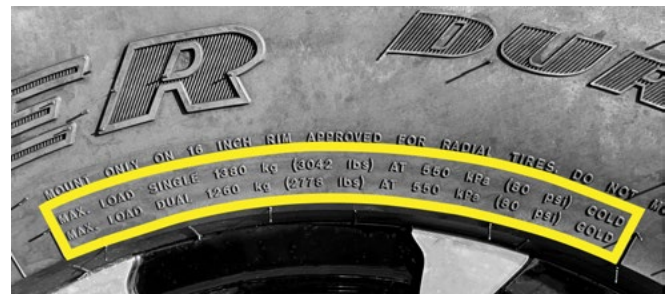

Choosing a Tire

Every tire sold in the United States has a tire rating stamped on the sidewall that shows a tire's maximum load at a defined pressure. Use the example above to help locate the max load rating in pounds (lbs) and tire pressure in pounds per square inch (psi) on your original equipment tires. Choose a tire with equal load ratings. For tire size, inflation and load specifications, [see Specifications on page 4-4.](#)

Maintenance

Max Load Single vs. Max Load Dual

Max Load Single refers to the tire rating for applications with only one wheel on each end of a single axle. *Max Load Dual* refers to the tire rating for dually wheels, where there are two wheels on each end of an axle for a total of 4 wheels on a single axle.

Don't confuse the terms Single and Dual with Tandem. A tandem axle refers to trailers with two axles, one behind the other.

For Airstream Travel Trailers, refer to the Max Load Single rating.

⚠ WARNING

Do not mismatch wheels and tires.

Axle systems are installed with hubs and drums that are compatible with many wheels used in the recreational vehicle industry that have matching bolt patterns. If the original manufacturer-installed equipment is in need of replacement, the wheel manufacturer should be contacted for proof of compatibility prior to replacement and use.

Customers replacing original with equipment that has not been tested for compatibility must ensure the replacements are compatible to the hub and drum assembly installed. Such elements of compatibility include, but are not limited to:

- Diameter of the hub-mounting surface.
- Stud length and diameter.
- Location and number of studs.
- Center hole diameter for the wheel.
- Wheel-mounting offset from the rim center.
- Rated capacity of the wheel.
- Wheel fastener torque.
- Wheel nut size and shape.
- Impact of any added wheel accessories (such as decorative center caps) that could affect proper seating of the wheel to the hub surface.

Refer to the following table for wheel specifications.

Wheel Specifications		
Size/Center Size In Inches	Lug Pattern	Model
16 x 6 / 5.5	6	All
All wheels have zero offset.		

Updating the TPMS Monitor and Multiplex Link

Any time you physically move a tire to a different position, such as changing or rotating tires, you must also update the TPMS monitor's sensor configuration and the link between the monitor and the Multiplex System.

A manual for the TPMS monitor has been provided with your owner's packet. Their manual contains warnings, cautions, and information on updating the sensors that should be reviewed.



1. Locate the TST Gateway transmitter (above). In the 28RB Classic, it is located behind a finished wood panel at the bottom of the galley. In the 30RB Classic, it is located in the compartment below the wardrobe closet. In the 33FB Classic, it is located by removing the drawer below the convection oven.
2. Press and hold **GO** on the TPMS monitor display for approximately 3 seconds until the screen displays **ACCEPT**.
3. Press **+** five times until the screen displays **SEND**.
4. Place the TPMS display close to the Gateway transmitter. Press the transmitter's button (which is actually a red blinking light) five times rapidly. The transmitter will then emit a beep.
5. Press and hold **SET** on the TPMS monitor until both the transmitter and monitor emit a beep, and the screen displays **ACCEPT**.

Lug Nut Torquing

Trailer wheels must carry much higher loads per wheel than passenger car or truck wheels. Each wheel may carry 1000 pounds and higher. Furthermore, wheels on tandem axle trailers do not steer, and are subjected to very high side load stress whenever the trailer makes a tight turn. When going around corners, especially on slow, tight turns, the wheels are subject to very strong side loads. This tends to flex the wheel and gradually loosen the wheel nuts. Although the materials and manufacturing methods are maximized for this kind of service, these extra loads can cause stress, which can result in flexing and loosening of wheel nuts.

Before each trip and any time a wheel is replaced, be sure to tighten the wheel nuts, following the lug-pattern sequence shown below. If the wheel was replaced, check the torque every 5, 25, and 50 miles.

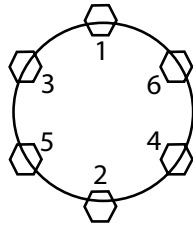

If you notice wheel wobbling, or hear a rattling sound coming from a wheel, especially at low speeds, a wheel lug nut may have come loose. This problem is usually caused by improper tightening, or by faulty or damaged lug bolt threads.

If suspicious of a loose lug nut, safely stop vehicle as soon as possible. Put up warning devices and check the tightness of all the lug nuts. Tighten all lug nuts to the specified torque, using a torque wrench. If stud threads are damaged or faulty, get professional service help.

⚠ WARNING

Use a torque wrench to tighten lug nuts. Tightening by hand or with an impact wrench is not recommended. For lug nut torque values, see [Specifications on page 4-4](#).

Spare Tire Carrier

The spare tire for Airstreams are stored under the front of the trailer. The front handle of the tire carrier is a 1 in. tube protruding out from under the front A-frame on the curbside. It is secured by a bracket and bolt along the inside of the A-frame rail. Removing the bolts allows the front of the tire carrier to be lowered and the spare tire to be removed.

⚠ WARNING

The spare tire carrier is designed to carry an undamaged tire and rim assembly of the type and size specified for the trailer. Never place a severely damaged wheel assembly with a damaged partial tire, or a rim only, in the carrier.

Tire Rotation

(10,000-mile intervals)

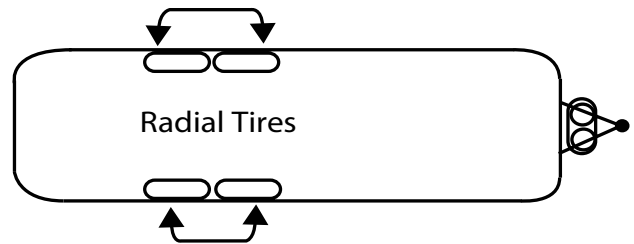

Axles and Brakes

 The following sections provide an overview of the inspection and maintenance requirements of the axle and brake components, as well as requirements for the breakaway switch. Consult the Dexter Operation Maintenance and Service Manual for detailed axle and brake information, and required maintenance intervals. It can be found by scanning the QR code above or visiting <https://www.dexteraxle.com/>.

⚠ WARNING

Read and follow all warnings and cautions and adhere to all required maintenance intervals found in the axle and brake component manufacturer's manual. Failure to properly maintain these components could lead to an accident, resulting in serious injury or death.

Axles and Bearings

⚠ WARNING

Never apply heat to the axle tube because the rubber providing the spring torsion action will be severely damaged.

Maintenance

Rubber Torsion Axle Alignment Specifications

Toe-In and Camber Specifications	
Toe-In each side 1/16 in.	Tolerance 1/8 in. + or -
Camber each side 3/4 degrees positive	Tolerance 3/4 degrees + or -

Nev-R-Lube Drums/Bearings

Dexter's Nev-R-Lube bearings are comprised of opposed tapered roller bearing cones sealed inside of a precision ground, one-piece double cup arrangement. These bearings are designed with a small amount of axial end-play. The end-play is essential to the longevity of the bearings service life.

Nev-R-Lube Bearing Inspection

1. Jack the trailer at the marked **JACK** location pad behind the axle on the main frame.
2. Check for excessive wheel end-clearance by pulling the tire assembly toward you and pushing the assembly away from you. Slight end-play is acceptable (0.001 to 0.010 in.).
3. Rotate the tire slowly forward and backward. The wheel assembly should turn freely and smoothly.
4. Excessive wheel end-play, restriction to rotation, noise, or bumpy rotation should be remedied by replacing the bearing unit.
5. Bearing units should be inspected when tires are rotated, or at least every year or 12,000 mi., whichever comes first.

A slight amount of grease-weeping from the seal area is normal. Excessive leakage may indicate abnormal bearing operation. See the Dexter Operation Maintenance and Service Manual for bearing end-play inspection, drum removal/installation, and bearing replacement procedures.

NOTICE

Airstream recommends that a qualified Dexter service technician perform these procedures due to the need for specialized tools and training.

Brakes

Brakes must be inspected and serviced immediately if performance loss is indicated. With normal use, servicing at 12-month or 12,000-mile intervals is usually adequate (whichever occurs first). With increased usage, this work should be done more frequently as required.

Breakaway Switch

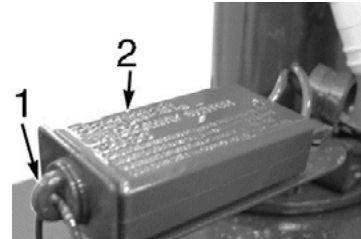

1. Pin
2. Breakaway Switch

To prevent corrosion within the breakaway switch, pull the pin out and spray the inside of the switch through the hole with an electric contact cleaner (such as Spra-Kleen). Applying a drop of light household oil on the pin and the groove near the base of the pin will allow the pin to operate freely. Immediately reinsert the pin. Perform this procedure every 90 days.

⚠ WARNING

Allow no more than 20 to 30 seconds pin separation as damage to brake magnets may occur.

Power Jack

 The power jack manufacturer's owner's instructions and parts list can be found by scanning this QR code and navigating to the instructions on Barker's website at <https://www.barkerimg.com/>. The following are basic maintenance requirements. Please refer to Barker's instructions for jack and bubble level adjustments, installation, and additional maintenance.

Power Jack Maintenance

- Once a year, the powerhead should be removed, and a liberal amount of grease (preferably grease with a high melting point) applied directly to the coupling on which the drive pin rests. Do not pour oil into the top of the jack post.
- Once a year, the housing cover should be removed and the gears inspected for proper lubrication. Remove all four screws and tap around the edge of the housing to free the cover. Do not use or insert a screwdriver blade to remove the cover, as it may damage mating surfaces. If lubrication is needed, use Mobilith SHC™ 460 or equivalent. Clean the mating surfaces before replacing the cover.

⚠ WARNING

Avoid the risk of injury to yourself and others. Keep hands and feet from under the foot plate when using the jack. Do not use or install dolly wheels on the power jack. Do not operate the toggle switch with the manual crank handle in place. Failure to comply could result in serious injury.

NOTE

When operating the power jack, pause briefly between switching up and down. Rapidly switching from up or down may cause the breaker to trip, momentarily interrupting power to the jack.

NOTICE

Never actuate the drain valve lever as long as the water heater is under pressure and/or is still warm.

Water Pump

Water Pump Access Locations

28RB Classic: under the galley; accessed by removing the bottom drawer.

30RB Classic: under the refrigerator; accessed by removing the bottom drawer.

33FB Classic: in the lavy under the wardrobe; pull outward on the finished wood panel to release it from the spring-loaded catches holding it in place.

Strainer Cleaning



Locate the strainer housing (on the water line leading to the water pump inlet). Remove the transparent bowl (turn counterclockwise), and carefully pull out the strainer/screen. Clean and rinse with water (use a household detergent if necessary). Reinstall the strainer and bowl, being careful not to damage the seal. The bowl collects sediment and should be positioned under the housing as depicted above. Check for leaks prior to resuming normal operation.

Fresh Water Tanks and Draining

Drain Valves



Drain valve locations are listed below by model; however, it may be helpful to know how to locate them should this information become outdated due to a change mid-production.

To locate internal low-point drain valves:

1. Look for a water line (usually white, red, or blue) protruding from the exterior underbelly. It will be a bare line with no valve. There may be two or more.
2. Establish a reference point to something inside the trailer, such as a window or vent.
3. Once inside, use your reference point to locate where the water line comes out of the floor. Trace the water line to the nearby low-point drain valve connection.

You can find where water lines come through the floor and locate valves by removing access panels inside or under furniture near your reference point; others are accessible by removing a drawer or opening a cabinet/compartment door. Sometimes access to internal valves is gained externally from inside a storage compartment.

To locate external fresh water tank valve(s), look for a stainless steel valve (right photo, above) and/or in-line brass valve(s) mounted to the galvanized steel underbelly (left photo, above).

For more information on the plumbing layout, [see Fresh Water Layouts on page 8-28](#).

Drain Valve Locations

The fresh water line drain valves are located on the exterior of the trailer for easier access. Between the tires you will see a galvanized steel box that is a few inches lower than the trailer frame. The line drains will be the two brass valves extending from the end of the pan. The stainless steel valve you will see is to drain the water tank. A second cold water low point valve is located in the outside utility compartment between the city water fill and waste tank flush.

Opening and Closing Valves

To open valves, turn the handle to align it with the waterline.

Fresh Water Tank Draining

Pumping the water out with the self-contained water pump can empty the fresh water tank. Simply turn on the pump switch and open a couple of faucets until the water will no longer drain out. Be sure to watch closely and turn the pump off when the tank runs dry. Pump damage can occur if the pump runs dry for more than a few minutes.

Water Heater Draining

Locate the drain valve on the Alde furnace/water heater located under the dinette seat. Before draining, switch off the fresh water pump and open all water taps to allow air to enter the hot water reservoir as water is emptied out. Open the drain valve by turning the lever. The water heater will drain directly below the trailer through the drain valve hose. If storing the trailer be sure to leave the valve in the open position until the next time the heater is used.

The hot water reservoir should be flushed if:

- The boiler has not been used for some time.
- The boiler is in continuous use supplying hot water (the trailer is being used full time). In this case the hot water reservoir should be emptied once a month.

NOTE

Refer to the Alde Operating Instructions for further information on the water heater.

NOTICE

The water heater and its plumbing should always be drained of fresh water when there is a risk of freezing or when the trailer is not in use. The warranty does NOT cover frost damage.

Sanitizing

Potable water systems require periodic maintenance to deliver a consistent flow of fresh water. Depending on use and the environment the system is subject to, sanitizing is recommended prior to storing and before using the water system after a period of storage. Systems with new components, or ones that have been subjected to contamination should also be disinfected as follows:

1. Use one of the following methods to determine the amount of common household bleach needed to sanitize the tank.
 - a. Multiply "gallons of tank capacity" by 0.13; the result is the ounces of bleach needed to sanitize the tank.
 - b. Multiply "Liters of tank capacity" by 1.0; the result is the milliliters of bleach needed to sanitize the tank.
2. Mix the proper amount of bleach into a container of water.
3. Pour the correct amount of solution (water/bleach) into the Fresh Water tank and fill with potable water.
4. Open all faucets (hot and cold) allowing the water to run until the distinct odor of chlorine is detected.
5. The standard solution must have 4 hours of contact time to disinfect completely. Doubling the solution concentration will allow for contact time of one (1) hour.
6. When the contact time is completed, drain the tank. Refill with potable water and flush the plumbing of all sanitizing solution.

Drain and Waste System

Your Airstream's drain and waste system includes holding tanks made from corrosion-free molded plastic. All tanks are emptied through a dump valve equipped with "T" handles, allowing you to individually open and drain each tank through a shared outlet and attached sewer hose.

Check your monitor panel frequently. The toilet bowl cannot be emptied when the waste water holding tank is full. If the gray water holding tank is overfilled, drain water will back up into the shower floor pan, resulting in unsanitary conditions.

Draining the tanks as described in this section will protect them from freezing during storage. When traveling in sub-freezing temperatures, use a winterizing solution designed for RV use. Follow the directions on the container.

Never drain the tanks at any place other than an approved dumping station. Almost all campgrounds will have a dump station. Online resources and park directories like Woodalls and Rand McNally usually list dumping stations.

CAUTION

Failure to monitor holding tank levels could result in unsanitary wastewater overflow.

NOTICE

Do not use a pipe snake on clogged drains; it could damage internal drain system components.

NOTICE

Never flush hard or solid objects, sanitary napkins, facial tissue, or paper towels down the toilet and into the holding tank. They can get caught in the dump valve mechanism. Colored toilet tissue is slower to dissolve than white. Most motorhome accessory stores offer tissue designed for RVs that will dissolve.

28RB Model:

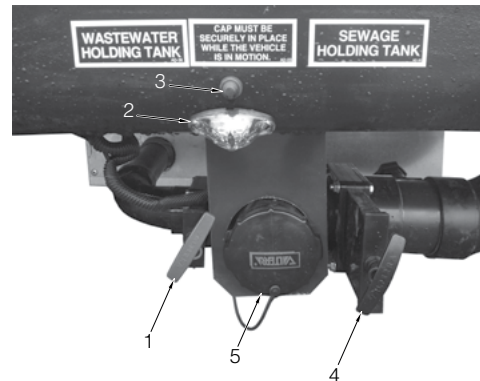

1. Gray Water Tank Dump Valve
2. Light
3. Light Switch
4. Waste Water Tank Dump Valve
5. Drain Cap (Drain Hose Hookup)

30RB and 33FB Models:

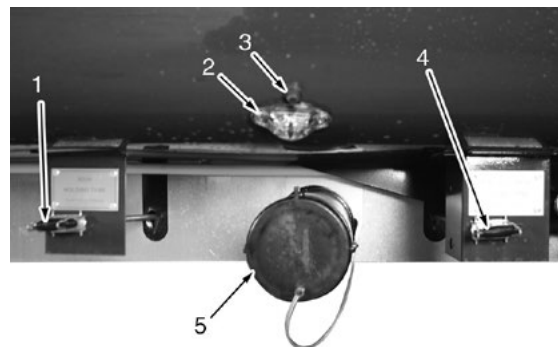

1. Waste Water Tank Dump Valve
2. Light
3. Light Switch
4. Gray Water Tank Dump Valve
5. Drain Cap

Emptying the Holding Tanks

Dump the waste water tank before the gray water tank. Doing so will help rinse the valve outlet and hose with gray tank water. Should solids accumulate, close the dump valve, fill the tank about half full with water, and then tow the trailer for a few miles. The turbulence of the water will usually dissolve the solids into suspension so the tank can be drained. To empty the tank(s):

1. Attach the sewer hose by pressing the bayonet fitting onto the dump valve outlet; rotate clockwise until secure.
2. Attach the outlet end of the hose to the disposal site; position the hose on a slope to ensure it drains completely.
3. Attach a water hose to the waste tank flush inlet on the side of the trailer (do not use the fresh water tank hose for this purpose).
4. Pull the waste tank dump valve handle outward to the stop and wait for the tank to fully drain.
5. Close the dump valve and flush the waste tank; [see Waste Tank Flush on page 8-15](#).
6. Pull the gray tank dump valve handle outward to the stop and wait for the tank to fully drain.
7. Close the dump valve and replace the bayonet ring cap before traveling.

Extended Stays

When connected to a sewer outlet in a park, keep the waste water holding tank dump valve closed and empty the tank every few days or when it becomes almost full. Draining a large volume of waste ensures toilet paper and other solids are washed entirely away. This practice will avoid the accumulation of solids in the waste holding tank.

Waste Tank Flush



Your Airstream has a garden hose-style connection to flush the waste water holding tank. Airstream advises flushing the waste tank each time it is emptied to prevent clogging of the water jets and accumulating waste solids inside the tank. Start by emptying the waste tank at an approved dump station and close the dump valve. To flush the tank:

1. Attach a water hose to the flush inlet (do not use the fresh water tank hose for this purpose).
2. Turn the water on and monitor the waste tank level. A spray head with multiple holes will spray the tank's interior surface. Fill the tank about half full and turn the water off.
3. Empty the waste holding tank; [see Emptying the Holding Tanks on page 8-15](#).
4. Close the waste holding tank valve and repeat this process until the water runs clear.

NOTICE

Use the waste tank flush regularly to keep the holes on the spray head from becoming clogged.

Drain System Cleaning

The only cleaning agents that can be used without causing harm to the system are household ammonia and tri-sodium phosphate in small quantities. Do not use any product that contains any portion of petroleum distillates. This type of product will attack the rubber seals of your toilet and dump valve. Also, do not use any dish detergent or abrasive cleaners. All products should be marked as approved for ABS drainage systems.

Winterizing and Storage

The main consideration in winterizing your trailer is to guard against freeze damage to the fresh water system, including lines, tank, and pump; the waste drain system, including traps and tanks; the water heater, and the batteries.

When storing your trailer for short or long periods, use the same precautions as you would in your home regarding perishables, ventilation, and rain protection. In addition, for prolonged storage periods, flush out all the drain lines and the holding tanks. Also, drain the entire water system, including the water heater and the water storage tank, using the following instructions.

Winterization Procedure

Below are the basic steps to completing the winterization process. It can be time-consuming and challenging to drain all of the water from the system. These tasks require an average mechanical skill level. If you are unsure of your ability to remove all the water from the system successfully, please seek assistance.

The goal is to get all the water out of the system to prevent freeze damage. We recommend allowing the system to drain for several days. You will need an adapter with an air regulator to connect an air compressor to the city water inlet and access to an air compressor.

1. Level the trailer from side to side and front to rear. Open all faucets.
2. Turn the water pump switch to the ON position to expel water from the storage tank
3. Open all drain valves including drain plug or valve on water heater and exterior water service valve.
4. While the water is draining from the system, open and flush the toilet-flushing valve. Operate the shower head while holding it down inside the tub and drain all water from the flexible hose.
5. Turn the pump switch OFF after all water has been removed from the storage tank.
6. Disconnect outlet hose from water pump. Turn the pump on until all the water is expelled. This water, about 1/2 cup, can be caught in a towel or rag.
7. Reconnect the water pump outlet.
8. Lower the front of the trailer as far as the jack will allow and let the trailer sit until water ceases to drain (no droplets are forming), then crank the jack up as high as it will go until water ceases to drain.

9. Before applying air pressure, set the water line valves as described below for "Blowing Out Water Lines." Once the valves are set, use the adapter mentioned at the beginning and apply, at max, 50 lbs. of air pressure to the city water inlet until only air is coming out of the faucets. You may need to open and close faucets one at a time and repeat this step several times to force out trapped water.

28RB and 30RB Classic

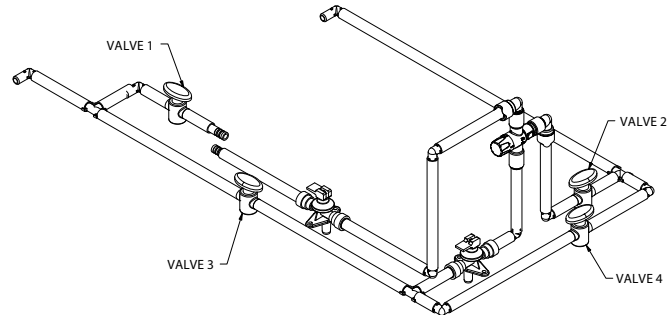

- Normal operation: 1, 2, 3 Open / 4 Closed
- Bypass Alde: 1, 2, 3 Closed / 4 Open
- Draining Water Lines: All Valves Open
- Blowing Out Water Lines, Close 1 & 2

33FB Classic

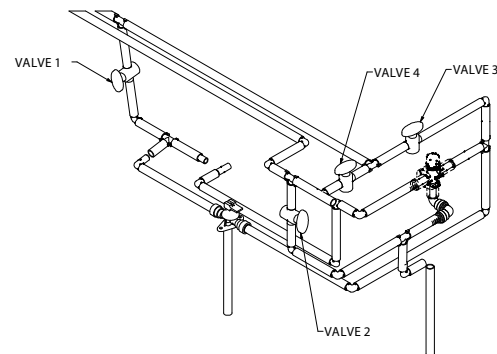

- Normal operation: 1, 2, 3 Open / 4 Closed
- Bypass Alde: 1, 2, 3 Closed / 4 Open
- Draining Water Lines: All Valves Open
- Blowing Out Water Lines, Close 1 & 2

10. Pour a cup of approved non-toxic RV antifreeze that has been listed by a recognized testing authority such as Underwriter Lab into the lavatory, sink, and tub drains to prevent trap freeze-up.
11. Be sure to open the waste-holding tank dump valves, and drain and flush the tanks thoroughly (*this is very important as the sewage in the tanks, if frozen, could seriously damage the tanks*). Plan ahead and have this done at a dump station.
12. For best practices: remove the batteries from your trailer and store in a cool, dry place where there is no danger of freezing. It is very important for optimum life of a battery to check it periodically and to keep it fully charged. This is especially true in winter months, when the temperature may drop below freezing. If the period of storage is for 30 days or less, you may turn off the battery disconnect switch rather than remove the batteries. Continue to check and recharge the batteries as needed, at least weekly in severe weather.

NOTICE

Remove all RV antifreeze spillage from all drain and faucet parts after winterizing. Failure to do so could result in damage to the finish of the plumbing fixtures.

Optional; An additional step to winterization is to consider adding a non-toxic RV antifreeze (approved for drinking water systems) to the water lines using the pre-installed Winterization Kit.

Before beginning, read the RV antifreeze manufacturer's label for instructions specific to the antifreeze you plan to use. It may take 2-3 gallons to fill the entire system so prepare accordingly. It will be helpful to have another person watching and operating the faucets and showerheads as you follow these steps.

The Winterization Kit is near the water pump, [see Water Pump Access Locations on page 8-11](#). For drain valve locations, [see Drain Valve Locations on page 8-12](#).

1. Reconnect all lines and showerheads that were disconnected in the previous steps.
2. Close all the drain valves.
3. Open the sink and shower drains if they are closed.

4. Open all the faucets, including the showerhead faucet handle and, if equipped, the external showerhead.

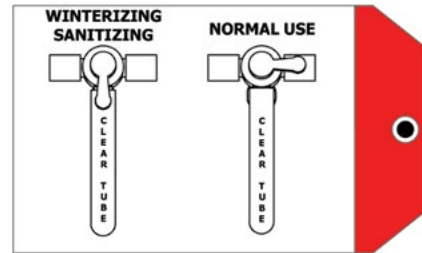

5. Go to the winterization kit and turn the valve handle to the winterizing position as indicated on the tag attached to the kit (shown above).
6. Uncoil the hose attached to the kit, remove the hose cap, and insert the hose down to the bottom of the RV antifreeze container.
7. Turn the pump switch on and run it until antifreeze starts coming out of the faucets. Once antifreeze runs from one tap, turn it off and continue to the next one. Move from one fixture to the next, shutting them off as you go until all the lines are full. As you empty each antifreeze container, turn the pump off, transition to a full container, and turn the pump back on to continue.
8. Allow the antifreeze to flow down drains. Flush the toilet and allow antifreeze to flow down the toilet. If equipped, operate the toilet hand sprayer until antifreeze is coming out. Work the hand shower sprayer while holding it down in the tub until antifreeze is coming out, and if equipped, do the same with the external showerhead. Any remaining antifreeze can be dumped down a drain.
9. Shut the pump off once all the lines are full.
10. Open all the faucets and leave them open.
11. Turn the winterization kit valve back to the normal use position, place the cap back on the hose, and coil it back up for storage.

NOTICE

Remove all RV antifreeze spillage from all drain and faucet parts after winterizing. Failure to do so could damage the plumbing fixture's finish. Do not use water to rinse antifreeze down the drain as it will dilute the antifreeze.

Maintenance

Restoring Service After Winter

1. Re-install the fully charged batteries.
2. Close the dump valve, all water faucets, and fresh water tank drain.
3. Add water to the fresh water tank.
4. Turn on the water pump.
5. Open and close the faucets one at a time until the water runs clear at all faucets signaling RV non-toxic antifreeze is flushed out of lines. Go back and recheck water clarity at all faucets.
6. Turn off the water pump.
7. Hook up to a city water supply, open the faucets again, and recheck water clarity.



Heating and Hot Water System

Please refer to the Alde manual in your owner's packet to ensure all required maintenance is performed. The following information is provided to aid in some of the required periodic maintenance and to locate access areas needed to perform required maintenance.

Checking Glycol Levels

Prior to using the system and periodically thereafter, check the heating system expansion tank fluid level. The tank has markings on the side to indicate the maximum and minimum fluid levels. In a cold tank, the fluid level should be about .4 inches above the minimum line.

The glycol mixture should be replaced every two years. If the glycol fluid is not replaced at appropriate intervals, there is a risk of frost damage, corrosion, bacterial growth and/or overheating. This should be performed by your Airstream dealer.

28RB	30RB	33FB
		

Expansion Tank Locations:

28RB Classic: inside the top cabinet behind the aft dinette seat.

30RB Classic: behind a removable panel inside the bathroom cabinet, above the toilet.

33FB Classic: inside the top cabinet behind between the shower and sofa wall

NOTICE

Only high-quality ready-mixed propylene glycol (with inhibitor) is intended for use in aluminum heating systems. The glycol must carry the label GRAS (generally recognized as safe). Alde recommends using only the ALDE brand glycol formulated explicitly for the Alde heating system.

NOTICE

The freshwater in the boiler should be drained during extended breaks and when there is a risk of frost; otherwise, the boiler may freeze, causing damage. The warranty does not cover frost damage.

Maintaining the Water Tank Air Cushion

The Alde boiler has an air cushion (air space) at the top of the hot water tank that must be maintained. The air cushion allows the water to expand when heated and absorbs any pressure shocks caused by the water pump in the heating system.



Restore the system's air cushion after 14 days of use. To restore the air cushion, turn off the fresh water pump and open the heating system safety/drain valve for a few seconds. To open the valve, lift the lever upward until it rests in the vertical (open) position, as shown above.

Valve Access: The valve for the 28RB Classic is under the aft dinette seat, and the valve for the 30RB and 33FB is under the forward dinette seat. To access the valve, pull outward on the upholstered panel facing the isle to release it from the spring-loaded catches holding it in place.

Main Door Care

Lubrication

Apply a little paraffin or grease to the striker pockets and a slight amount of household oil to the lock mechanisms to keep the locks operating smoothly. Also, lubricate the hinge pins periodically with household oil. Use the lubricant sparingly and immediately remove any excess from exterior skin.

Adjustment

Main door adjustment can be affected by:

- The trailer being improperly leveled (causing twisting of trailer body/shell).*
- Striker bolt alignment being out of adjustment, (striker bolt is adjustable).
- Screen door being out of adjustment, resulting in a situation of the door rubbing the frame, or not closing flush (which will create pressure on the door).
- Main door has come open at some point, introducing a change to the contour of the door frame (check for sheared rivets on interior skin of door).
- * When using the stabilizers (for eliminating movement-not leveling) on your Airstream, be sure to check the fit of your main door before and after extending stabilizers. The fit of the main door can be affected if trailer is not level side to side and front to back.

Windows

Sticking Windows

Forcing the window open may cause the window to shatter. Always follow the guidelines below for releasing a stuck window.

1. Unlatch the window latches securing the windows on the interior.
2. Apply some 303 Aerospace Protectant to a nylon wedge window tool.
3. Starting in the corner, tuck the end of the nylon tool under the glass and gently slide to opposite end.

⚠ WARNING

Prying up or applying pressure to the window may cause the window to shatter, resulting in personal injury or unit damage.

4. Once the window is released, wash the gasket with a mild soap and water solution, and dry.
5. Apply 303 Aerospace Protectant (Airstream part # 44845WR-01) to the window gasket. To apply, spray/pour 303 onto a soft rag or sponge and apply a generous coating directly to the gasket. Remove any residue that comes in contact with the exterior aluminum skin. This may be ordered through the Airstream dealer or at the Airstream online store at www.airstream.com.

Electrical Diagrams

12-Volt Main Schematic

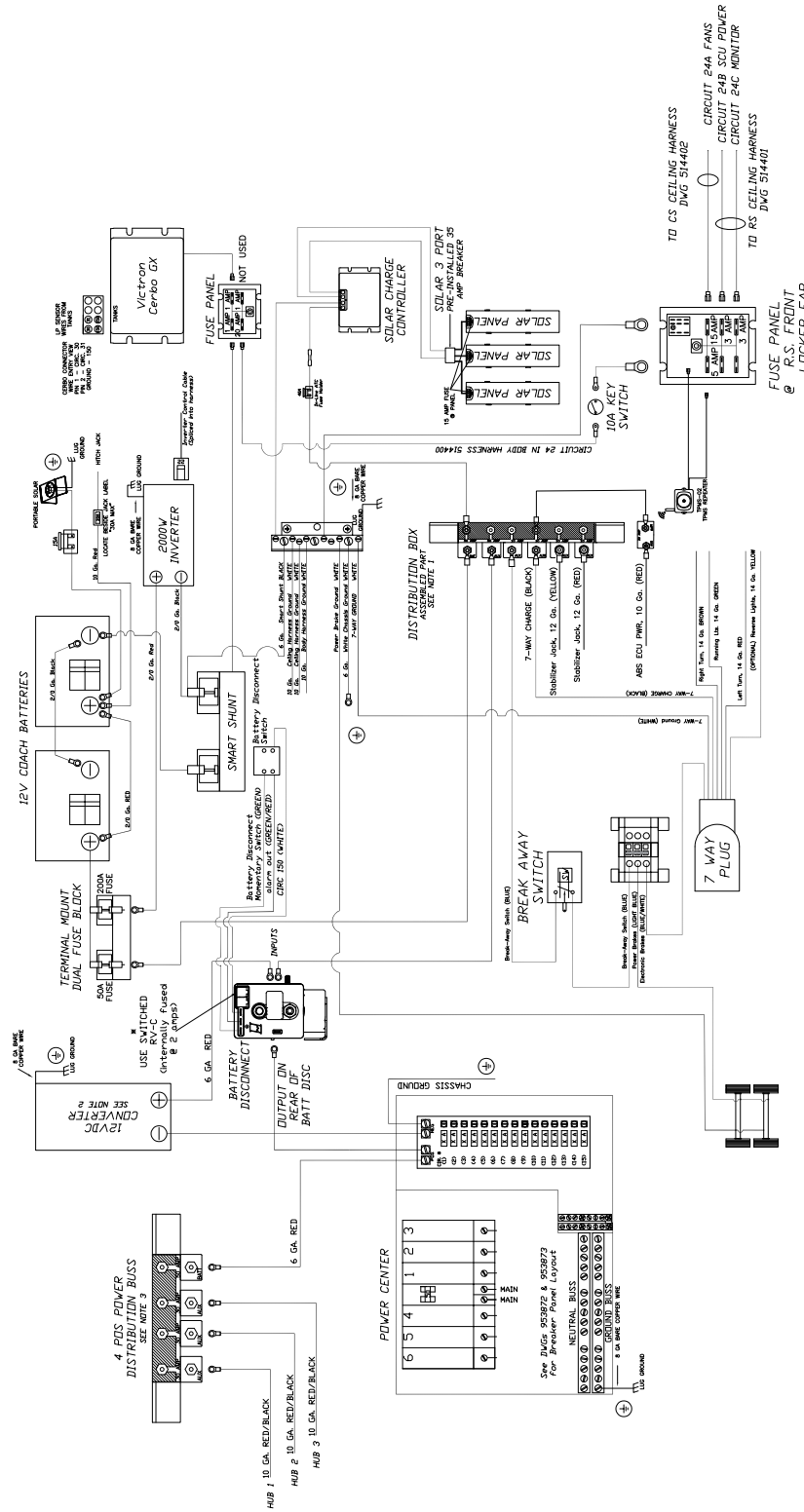

NOTE: THE LINE SIDE OF THE BREAKER IS INDICATED BY A COPPER STUD. ALL COPPER STUDS CONNECT TO THE COPPER BUS BAR, EXCEPT:

1. CB1 & CB2 TYPE 2, 30AMP BREAKERS
CB3, CB5, & CB6 TYPE 2, 30AMP BREAKERS
2. 50A CONVERTER IS A SEPARATE GROUND DEVICE TO DC FUSE PANEL WITH 8 GA. WHITE TEW 10SC RATED WIRE.
3. SEE DWG 953849 FOR NETWORK SCHEMATIC
SEE DWG 514457 FOR 4 PDS DISTRIBUTION BUSS ASSEMBLY

THIS DOCUMENT IS FOR REFERENCE ONLY. FOR BOM PARTS LIST SEE 953874

28RB Classic (50 Amp) - CSA

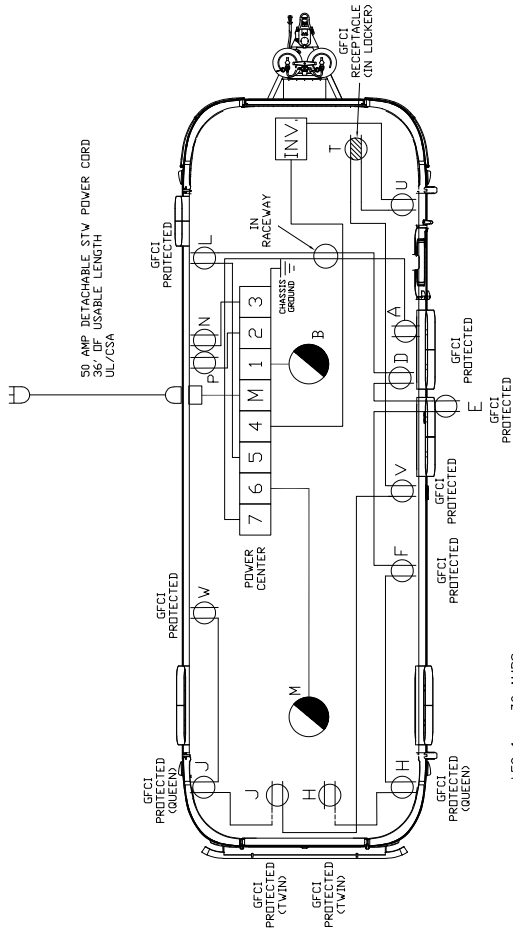

- LEG. 1 36 AMPS
- CIR. 1 20 AMP HACR BREAKER 12-2 ROMEX W/GND
 - B. FRONT A/C (LIVING AREA) 16.00 AMPS
 - CIR. 2 15 AMP HACR BREAKER 14-2 ROMEX W/GND
 - P. CONVERTER (15A SINGLE RECEPT) 8.00 AMPS
 - CIR. 3 15 AMP HACR BREAKER 14-2 ROMEX W/GND
 - N. MICROWAVE RECEPT (15A SINGLE RECEPT) 12.00 AMPS
- LEG. 2 44.00 AMPS
- CIR. 4 15 AMP HACR BREAKER 14-2 ROMEX W/GND
 - S. 2000 WATT INVERTER WITH 15A TRANSFER SWITCH 0.00 AMPS
 - CIR. 4I 2000W INVERTER 12-2 ROMEX W/GND
 - T. BRING YOUR OWN DEVICE (GFCI RECEPT) 1.00 AMPS
 - U. CURBSIDE LIVING AREA RECEPT 1.00 AMPS
 - V. MAIN LIVING AREA TV RECEPT 1.00 AMPS
 - W. BEDROOM TV RECEPT 1.00 AMPS
 - J. R.S. BEDROOM NIGHTSTAND RECEPT 1.00 AMPS
 - D. DINETTE RECEPT 1.00 AMPS
 - E. OUTSIDE RECEPT 1.00 AMPS
 - F. BATH RECEPT 1.00 AMPS
 - H. C.S. BEDROOM NIGHTSTAND RECEPT 1.00 AMPS
 - L. GALLEY RECEPT 1.00 AMPS
- TOTAL = 6.00 AMPS
- TOTAL = 6.00 AMPS
- CIR. 6 20 AMP HACR BREAKER 12-2 ROMEX W/GND
 - M. REAR A/C (BEDROOM) 16.00 AMPS
 - CIR. 7 20 AMP HACR BREAKER 12-2 ROMEX W/GND
 - A. ALDE SYSTEM (20 AMP SINGLE) 16.00 AMPS

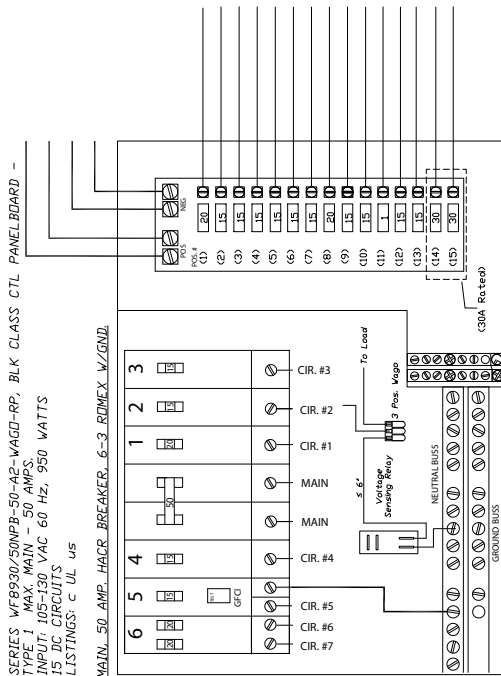

BREAKER LABEL	DESCRIPTION
CHR 3	15 AMP MICROWAVE RECEPT
CHR 2	15 AMP CONVERTER
CHR 1	20 AMP FRONT A/C (LIVING AREA)
MAIN	50 AMP MAIN BREAKER
CHR 4	15 AMP INVERTER RECEPTS: C.S. FRONT, FRONT & REAR TV, BYOD, RS NIGHTSTAND RECEPT
CHR 5	15 AMP GFI C.S. NIGHTSTAND RECEPT (BEDROOM)
CHR 6	20 AMP ALDE SYSTEM
CHR 7	20 AMP ALDE SYSTEM

- NOTE 1:
DC TO AC 2000W INVERTER RATED AT 16.6 AMP INVERTING TRANSFER SWITCH RATED AT 30 AMPS
LISTING(S): UL 458 TESTED, ULC
2/0 GA. STRANDED POSITIVE RUNS FROM THE BATTERIE(S) THROUGH A 200 AMP IN-LINE FUSE BEFORE ATTACHING TO THE INVERTER.
NEGATIVE CABLE RUNS FROM THE BATTERIE(S) THROUGH A GROUND TERMINAL OR SHUNT BEFORE ATTACHING TO THE INVERTER.
- NOTE 2:
NON-CURRENT CARRYING METAL PARTS THAT COULD BECOME ENERGIZED BY 120 VOLTS ARE GROUNDED BY A GROUND PIGTAIL FROM THE BARE COPPER WIRE OF THE ROMEX CABLE TO EITHER A GROUND SCREW OR GROUND CLIP ON THE PART.
- NOTE 3:
ALL INTERIOR RECEPTACLES 15A DUPLEX UNLESS OTHERWISE NOTED
ALL RECEPTACLES BLACK UNLESS OTHERWISE NOTED

30RB Classic (50 Amp)

CRT. SYM	DESCRIPTION	RATED (AMPS)	WIRE GA.	BREAKER TYPE
1 A	ALDE SYSTEM (SINGLE 20AMP)	16.00	12-2	20A HACR
2 B	FRONT AIR CONDITIONER	16.00	12-2	20A HACR
3	GFCI CIRCUIT	9.00	14-2	
C	GALLEY END PANEL RECEPT	1.50	14-2	
D	GALLEY RECEPT	1.50	14-2	
E	OUTSIDE RECEPT (WHITE RECEPT)	1.50	14-2	15A HACR GFI
F	BATHROOM RECEPT	1.50	14-2	
G				
H	RS LIVING AREA RECEPT	1.50	14-2	
J	CS LIVING AREA RECEPT	1.50	14-2	
4 K	REAR AIR CONDITIONER	16.00	12-2	20A HACR
L	INVERTER (SINGLE 20AMP)	14.20	12-2	20A HACR
6	REAR ROOM RECEPTS & CONVERTER	11.00	14-2	
M	AC TO DC CONVERTER	8.00		
N	CS NIGHTSTAND RECEPT	1.50	14-2	15A HACR
P	RS NIGHTSTAND RECEPT	1.50	14-2	
7	INVERTER	6.00	12-2	
S	INVERTER (2000VA)	0.00	12-2	
T	BEDROOM TV RECEPT	1.50	12-2	
U	BRING YOUR OWN DEVICE RECEPT	1.50	12-2	15A HACR
V	DINETTE TV RECEPT	1.50	12-2	
W	DINETTE RECEPT	1.50	12-2	
TOTAL POTENTIAL CURRENT				88.20

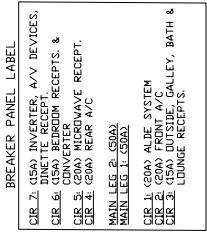
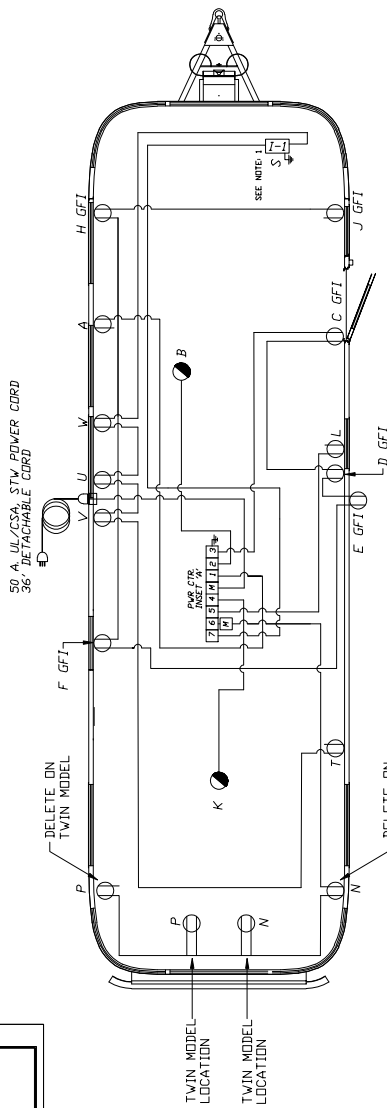
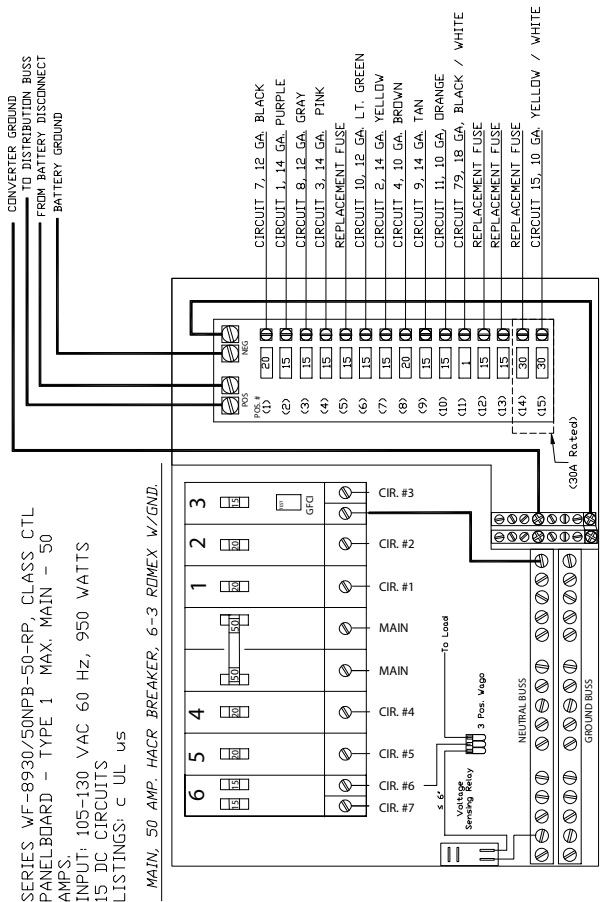

NOTE 1:
2000VA INVERTER, A/V DEVICES, 20A BEDROOM RECEPTS, & CONVERTER
NON-CURRENT CARRYING METAL PARTS THAT COULD BECOME ENERGIZED BY 120 VOLTS ARE GROUNDED BY A GROUND PUTTAL FROM THE BARE COPPER WIRE OF THE RDMEX CABLE TO EITHER A GROUND SCREW OR GROUND CLIP ON THE PART.

NOTE 2:
NON-CURRENT CARRYING METAL PARTS THAT COULD BECOME ENERGIZED BY 120 VOLTS ARE GROUNDED BY A GROUND PUTTAL FROM THE BARE COPPER WIRE OF THE RDMEX CABLE TO EITHER A GROUND SCREW OR GROUND CLIP ON THE PART.

NOTE 3:
ALL INTERIOR RECEPTS ARE BLACK UNLESS NOTED OTHERWISE
ALL RECEPTS ARE 15A DUPLEX UNLESS NOTED OTHERWISE

30RB Classic (50 Amp) - CSA

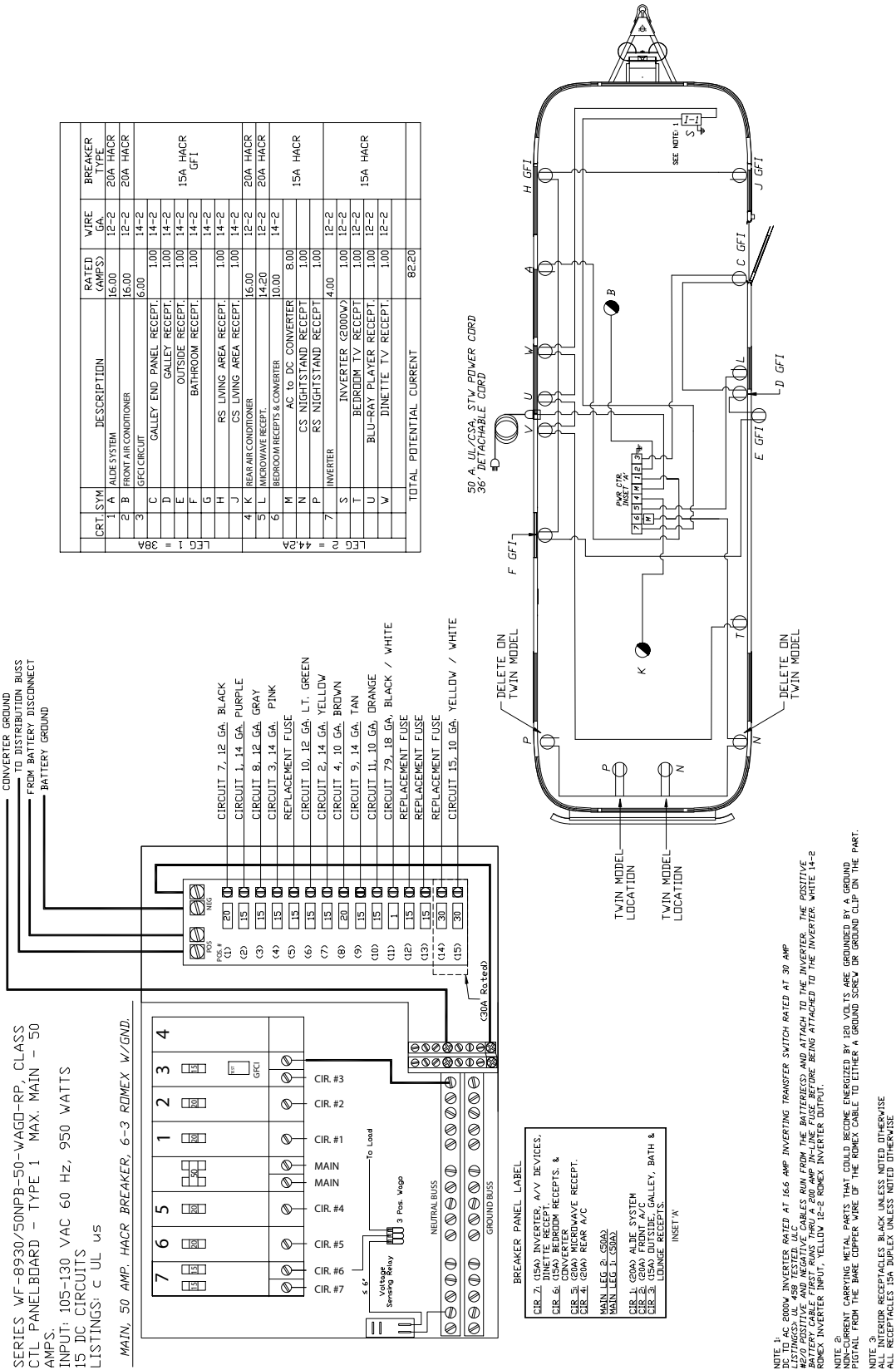

33FB Classic (50 Amp)

CRT. SYM	DESCRIPTION	RATED (AMPS)	WIRE GA.	BREAKER TYPE
1 A	ALDE SYSTEM (SINGLE 20AMP)	16.00	12-2	20A HACR
2 B	REAR AIR CONDITIONER	12.70	12-2	20A HACR
3	GFCI CIRCUIT	6.00	14-2	
C	BATHROOM RECEPT.	1.50	14-2	
D	DESK RECEPT. (SINGLE)	1.50	14-2	
E	GALLEY RECEPT.	1.50	14-2	15A HACR GFCI
F	OUTSIDE RECEPTACLE (WHITE RECEPT.)	1.50	14-2	
4 G	FRONT AIR CONDITIONER	12.70	12-2	20A HACR
5 H	AC to DC CONVERTER	8.00	14-2	15A HACR
6 J	MICROWAVE RECEPT (SINGLE 20AMP)	14.20	12-2	20A HACR
7 K	INVERTER	8.70	12-2	
K	INVERTER	0.00	12-2	
L	DINETTE RECEPT.	1.50	12-2	
M	BRING YOUR OWN DEVICE RECEPT.	1.50	12-2	
N	TV/LIFT RECEPT	3.00	12-2	15A HACR
Q	SOUND BAR RECEPT (15A SINGLE)	1.20	12-2	
P	BEDROOM TV RECEPT.	1.50	12-2	
8	BEDROOM RECEPTS:	3.00	14-2	
R		1.50	14-2	15A HACR
T	TOTAL POTENTIAL CURRENT	81.30		

TO DISTRIBUTION BUSS FROM BATTERY DISCONNECT BATTERY GROUND

LEG 1 = 380A
LEG 2 = 50.2A

MAIN, 50 AMP HACR BREAKER, 6-3 ROMEX W/GND.

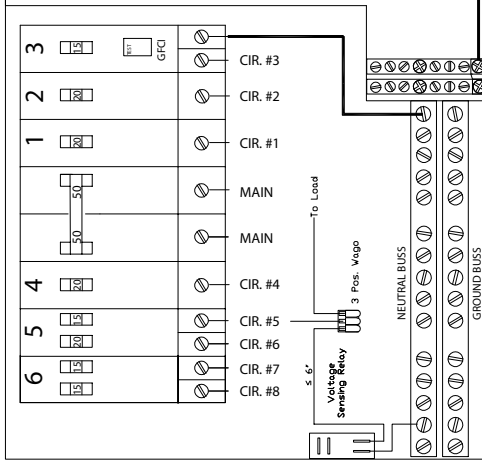

CIRCUIT #,

- CIRCUIT 1, 14GA. PURPLE
- CIRCUIT 2, 10GA. YELLOW
- CIRCUIT 3, 14GA. PINK
- CIRCUIT 4, 14GA. ORANGE
- CIRCUIT 5, 12GA. BLUE
- REPLACEMENT FUSE
- CIRCUIT 7, 12GA. BLACK
- CIRCUIT 8, 14GA. GRAY
- CIRCUIT 9, 16GA. TAN
- CIRCUIT 10, 12GA. LT. GREEN
- CIRCUIT 14, 16GA. PINK
- CIRCUIT 79, 18GA. BLACK/WHITE
- REPLACEMENT FUSE
- CIRCUIT 11, 10GA. GREEN
- CIRCUIT 15, 10 GA. YELLOW / WHITE

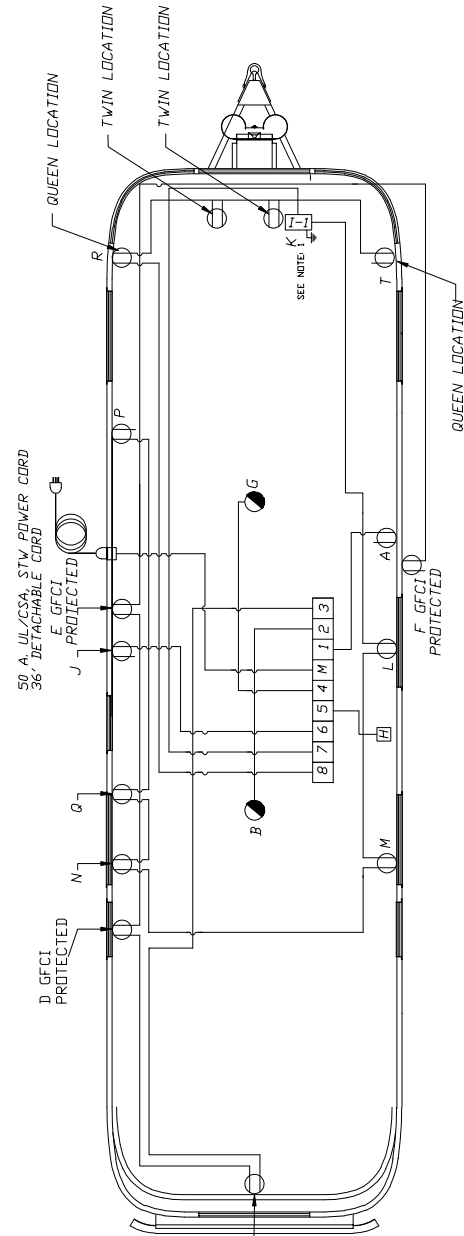

BREAKER PANEL LABEL
 CIR. 8. (15A) BEDROOM RECEPTS
 CIR. 7. (15A) INVERTER, A/V DEVICES, DINETTE RECEPT.
 CIR. 6. (20A) MICROWAVE RECEPT.
 CIR. 5. (15A) AC to DC CONVERTER
 CIR. 4. (15A) FRONT A/C
 MAIN LEG 2. (50A)
 MAIN LEG 1. (50A)
 CIR. 1. (20A) ALDE SYSTEM
 CIR. 2. (20A) REAR A/C
 CIR. 3. (15A) OUTSIDE, GALLEY, BATH & LOUNGE RECEPTS.
 INSET 'A'

- NOTE 1: AC 200MA INVERTER RATED AT 16.6 AMP INVERTING TRANSFER SWITCH RATED AT 30 AMP LISTINGS: UL 458 TESTED ULC #270 POSITIVE AND NEGATIVE CABLES RUN FROM THE BATTERIES) FIRST RUNS THRU A 200 AMP IN-LINE FUSE BEFORE BEING ATTACHED TO THE INVERTER WHITE 14-2 ROMEX INVERTER INPUT. YELLOW 12-2 ROMEX INVERTER OUTPUT.
- NOTE 2: NON-CURRENT CARRYING METAL PARTS THAT COULD BECOME ENERGIZED SHOULD BE GROUNDING METAL FROM THE BASE COPPER WIRE OF THE ROMEX CABLE TO EITHER A GROUND SCREW OR GROUND CLIP ON THE PART.
- NOTE 3: ALL INTERIOR RECEPTACLES BLACK UNLESS NOTED OTHERWISE ALL RECEPTACLES 15A DUPLEX UNLESS NOTED OTHERWISE

33FB Classic (50 Amp) - CSA

CRT. SYM	DESCRIPTION	RATED (AMPS)	WIRE GA.	BREAKER TYPE
1 A	ALDE SYSTEM (SINGLE 20AMP)	16.00	12-2	20A HACR
2 B	REAR AIR CONDITIONER	12.70	12-2	20A HACR
3	GFCI CIRCUIT	4.00	14-2	
	BATHROOM RECEPT.	1.00	14-2	
	DESK RECEPT.	1.00	14-2	
	GALLEY RECEPT.	1.00	14-2	
	OUTSIDE RECEPTACLE(WHITE RECEPT.)	1.00	14-2	
4 G	FRONT AIR CONDITIONER	12.70	12-2	20A HACR
5 H	AC TO DC CONVERTER	8.00	14-2	15A HACR
6 J	MICROWAVE RECEPT(SINGLE 20 AMP)	14.20	12-2	20A HACR
7 K	INVERTER	6.70	12-2	
	INVERTER	0.00	12-2	
L	DINETTE RECEPT.	1.00	12-2	
M	BRING YOUR OWN DEVICE RECEPT.	1.00	12-2	
N	T.V./TV LIFT RECEPT	2.50	12-2	15A HACR
Q	SOUNDBAR RECEPT(SINGLE 15A)	1.20	12-2	
P	BEDROOM TV RECEPT.	1.00	12-2	
8	BEDROOM RECEPTS.	2.00	14-2	
R		1.00	14-2	15A HACR
T		1.00	14-2	
TOTAL POTENTIAL CURRENT				76.30

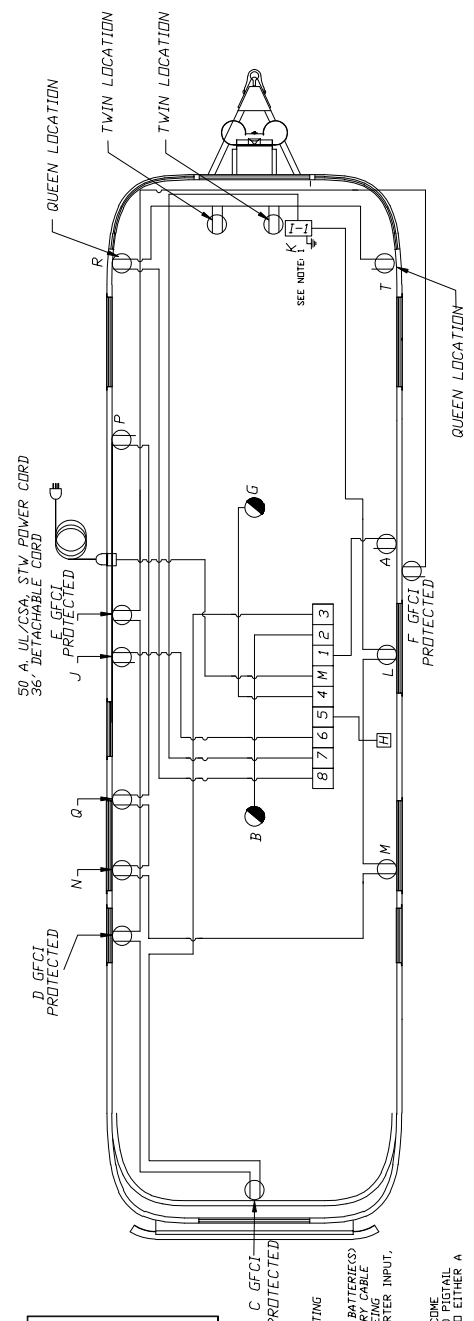
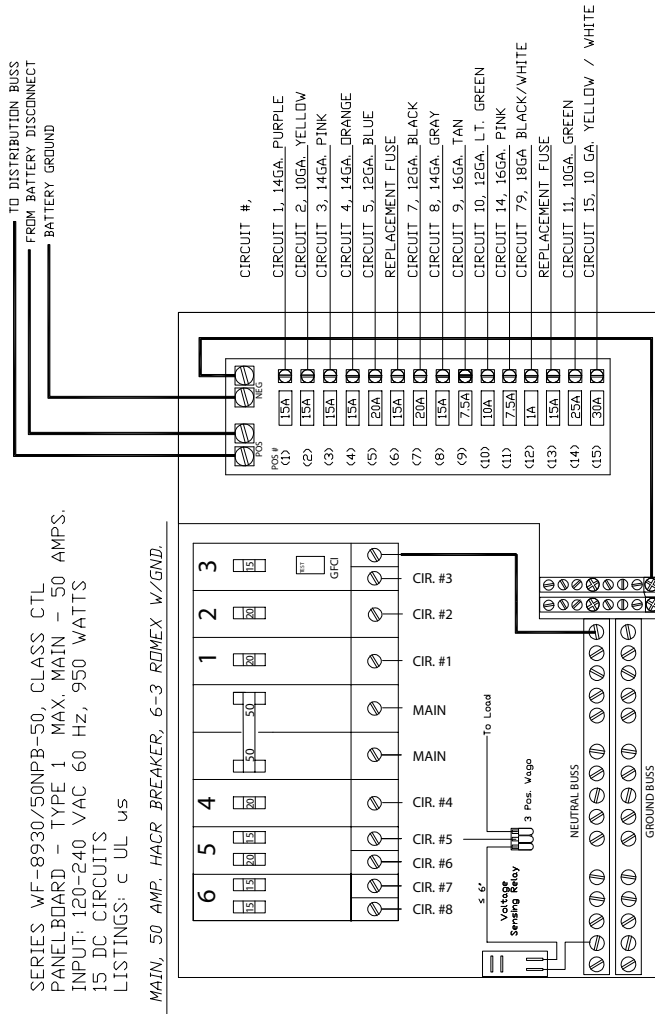

BREAKER PANEL LABEL

CIR. 3: (15A) BEDROOM RECEPTS (GALLEY, DINETTE, A/V DEVICES, DINETTE RECEPT.)

CIR. 4: (20A) MICROWAVE RECEPT.

CIR. 5: (15A) AC TO DC CONVERTER

CIR. 8: (20A) FRONT A/C

MAIN LEG. 2: (50A)

MAIN LEG. 1: (50A)

CIR. 1: (20A) ALDE SYSTEM

CIR. 2: (16A) AC GALLEY, BATH & LOUNGE RECEPTS.

INSET 'A'

NOTE 1: AC 2000V INVERTER RATED AT 16.6 AMP INVERTING DC TO AC. NON-CURRENT CARRYING METAL PARTS THAT COULD BECOME ENERGIZED BY 120 VOLTS ARE GROUNDING BY A GROUND PIGTAIL ATTACHED TO THE INVERTER. THE POSITIVE BATTERY CABLE AND A TACH TO THE INVERTER. THE POSITIVE BATTERY CABLE ATTACHED TO THE INVERTER. WHITE 14-2 ROMEX INVERTER INPUT, YELLOW 12-2 ROMEX INVERTER OUTPUT.

NOTE 2: NON-CURRENT CARRYING METAL PARTS THAT COULD BECOME ENERGIZED BY 120 VOLTS ARE GROUNDING BY A GROUND PIGTAIL ATTACHED TO THE INVERTER. THE POSITIVE BATTERY CABLE TO EITHER A GROUND SCREW OR GROUND CLIP ON THE PART.

NOTE 3: RECEPTOR RECEPTACLES BLACK UNLESS NOTED OTHERWISE ALL RECEPTACLES 15A DUPLEX UNLESS NOTED OTHERWISE

Solar Panel Wiring

Your Classic comes factory equipped with solar panels on the roof. For your convenience Airstreams has also installed a plug for a portable solar panel at the front of the trailer near the battery box. Simply plug the power cord from your portable solar panel into the front port for extra solar power. The solar panel has a charge controller that is mounted close to the battery buss bars, as the battery leads and Cat 5 wire are hooked into it to sense the actual battery charge. For a detailed drawing of the 12V and solar system, see the 12V Main Schematic at the beginning of this section.

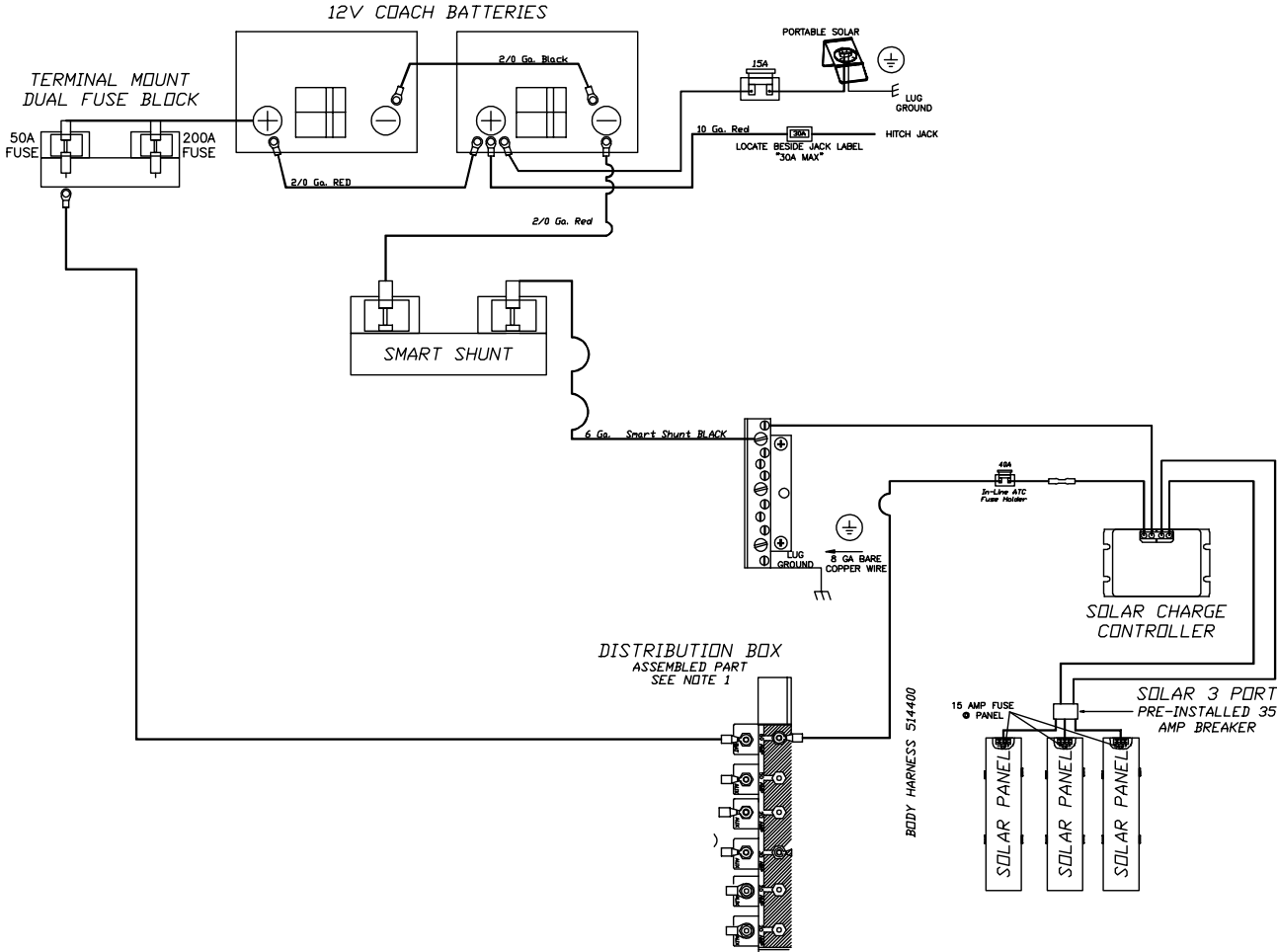

Fresh Water Layouts

28RB Classic

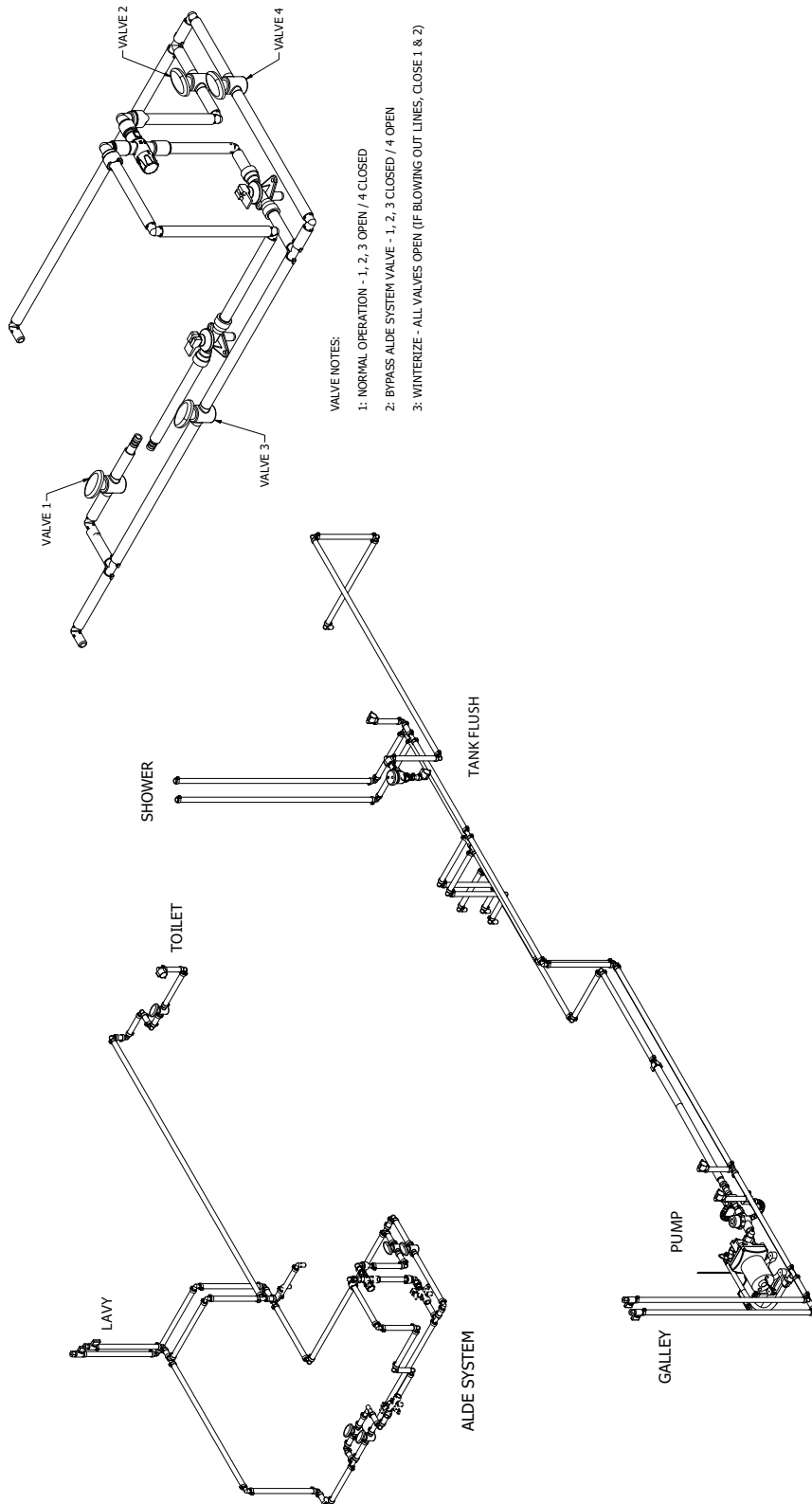

Fresh Water Layout - 30RB Classic

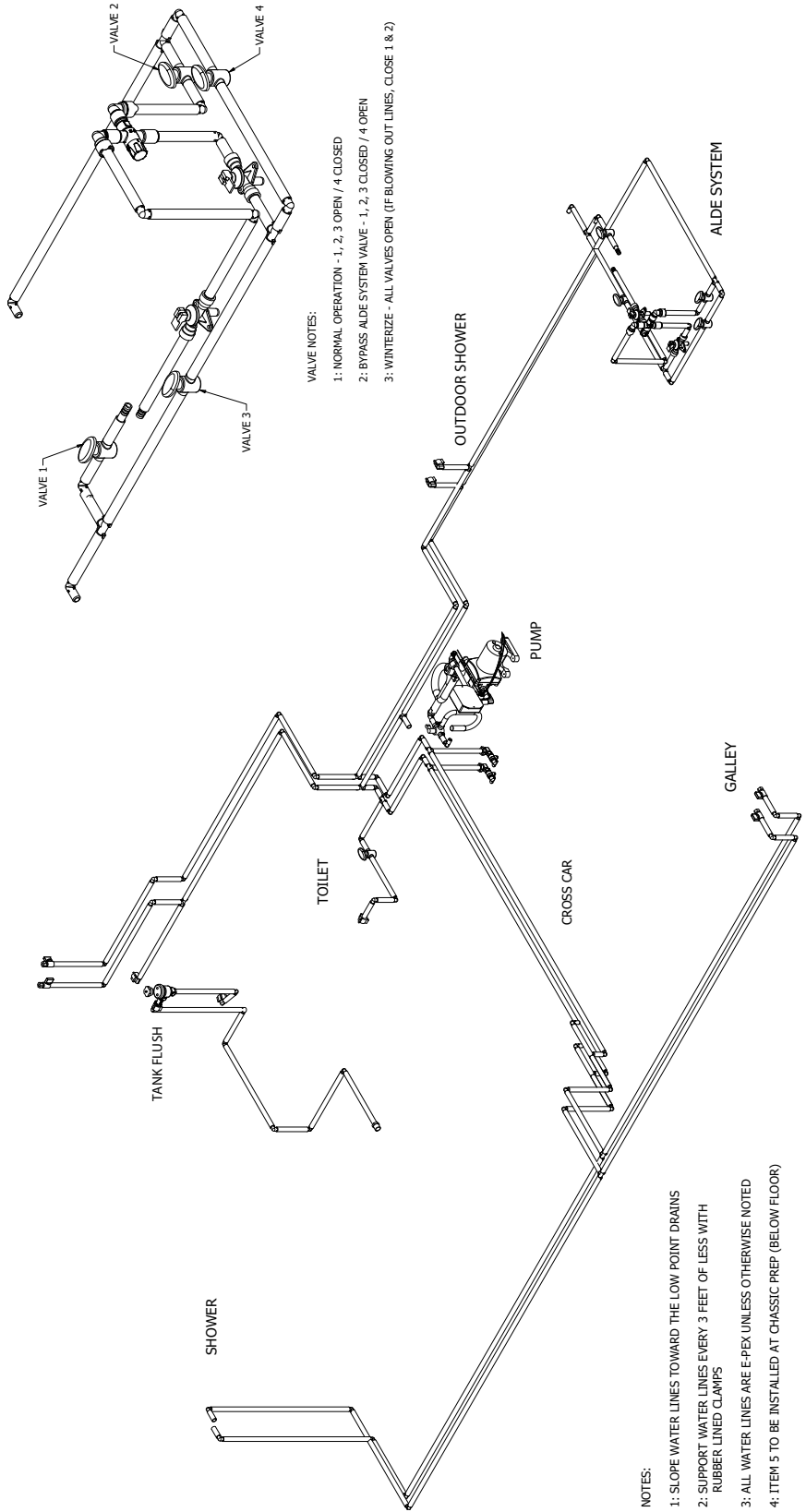

Fresh Water Layout - 33FB Classic

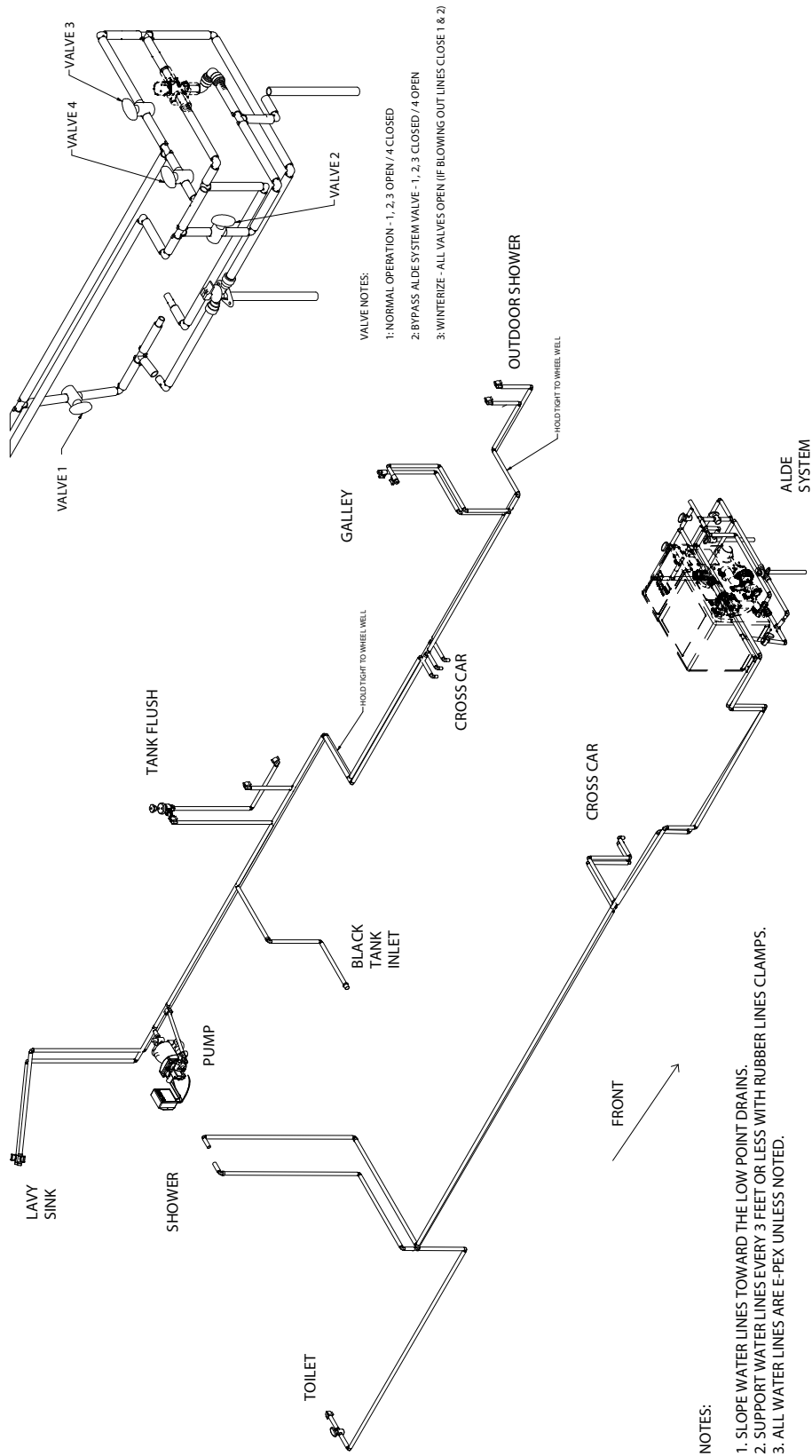

NOTES:

1. SLOPE WATER LINES TOWARD THE LOW POINT DRAINS.
2. SUPPORT WATER LINES EVERY 3 FEET OR LESS WITH RUBBER LINES CLAMPS.
3. ALL WATER LINES ARE E-PEX UNLESS NOTED.

FAQs and Answers

Electrical

1. *What size of generator is needed to operate my Airstream?*

Answer: A 1,000-watt generator may be used to charge just the batteries. However, if you are wanting to run appliances such as microwave or AC units, it is recommended to have at least 4,000 watts or more, which is enough power to run one major appliance. (This is for a 30 amp system).

* Many Airstreamers accomplish this using two portable generators running in parallel.

2. *What can I plug into the inverter outlets in my Airstream?*

Answer: These plugs are intended for charging things such as laptops and phones, and TV usage. Plugging in items such as vacuums, hair dryers, etc., may harm the system; [see Inverter on page 5-10](#).

3. *What size batteries are in my Airstream?*

Answer: Your Airstream is equipped with two BattleBorn 100Ah 12V LiFePO4 batteries; [see Batteries on page 5-12](#).

4. *Do you recommend using a surge protector when plugged into shore power?*

Answer: Your Airstream is breaker protected. However, with the use of more personal electronic devices and the number of RV users in parks, added protection is always a plus.

5. *What is the battery disconnect switch function?*

Answer: The disconnect switch separates the batteries from the 12-volt distribution panel. If the trailer is disconnected from shore power and the switch is turned OFF, the batteries are disconnected, the 12-volt fuse panel will not receive power from the converter or batteries and the inverter will turn off.

The batteries will be charged through the converter charging system, solar system, and tow vehicle regardless of whether the battery switch is ON or OFF.; [see Battery Disconnect on page 5-12](#).

6. *What can I do if the power jack will not function?*

Answer: The jack may be raised and lowered using the hand crank provided. Check for 12V power and proper grounding at the jack. For more information, [see Power Jack on page 6-9](#) and [see Power Jack on page 8-11](#).

7. *What does the power converter do in my trailer?*

Answer: The converter takes 120-volt AC shore power and turns it into 12-volt DC to keep batteries charged and power 12-volt items in your trailer; [see Converter/Charger on page 5-10](#).

Appliances

1. *I am planning for a trip in my Airstream. How should I get the refrigerator cooled down?*

Answer: Cooling time will vary with exterior temperatures and time of day. Start by pre-cooling your refrigerator at least 12 hours prior to loading your refrigerator. Always pre-cool food in your refrigerator or freezer to reduce cooling time. Don't pack food too tightly in compartment as to prevent circulation around food items. Normal refrigerator operating temperatures are 34 to 40°F; [see Refrigerator on page 5-26](#).

2. *My air conditioner freezes up. What is the problem?*

Answer: In high humidity conditions, the AC manufacturer recommends you operate your AC (manual mode) on the high fan setting and all vents should be open to have maximum air flow over the coils; this helps reduce icing. Also, dirty air conditioner filters can restrict air flow and cause the AC to ice up; [see Air Conditioner and Integrated Heat Pump on page 5-23](#).

Maintenance

Plumbing

1. ***Is it recommended to leave the dump valves open when connected to a sewer hookup?***

Answer: No. This would cause a buildup inside the tank; [see Extended Stays on page 8-15](#).

2. ***How does the waste tank flush work?***

Answer: For information on how to use the tank flush, [see Waste Tank Flush on page 8-15](#).

3. ***Do I need a water regulator?***

Answer: No, your Airstream is equipped with a built in regulator rated for 50 psi.

4. ***How do I get fresh water into my trailer?***

Answer: You can use the on board fresh water tank and 12-volt pump for your water supply when boon docking, or hook to an external water source via non-toxic water hose to exterior water inlet when parked at a campground; [see Gravity Water Fill on page 6-6](#) and [see City Water Hookup on page 6-6](#).

5. ***What is the difference between the gray water tank and the waste water tank?***

Answer: The gray water tank holds water from shower and sink drains. The waste water tank holds sewer water from the toilet.

Audio-Video

1. ***My TV reception is poor. What can I check?***

Answer: Verify your antenna booster is set to proper selection (On- for antenna and Off- for cable satellite). You should also make sure connections are tight on your TV; [see All-In-One Antenna on page 5-22](#).

Maintenance

1. *Where can I find my trailer serial number?*

Answer: A label is attached on the roadside sheet at the front side sheet seam. This label will also provide the inflation pressure of the tires and GVWR. The serial number of the trailer is also stamped on the street side of the A frame by the LPG tanks.

2. *Awning suggestions:*

Your Zip Dee awning is intended to provide shade. Your awning can be used in light rain conditions if front or rear is tilted to let water run off. Light winds should not affect awning use. If you are leaving your trailer for long periods or in threatening weather, the awning should be retracted. Visit <https://support.airstream.com> to view User Guide Videos on this subject.

3. *Cleaning the exterior of my Airstream. Suggestions:*

Airstream recommends washing the trailer using a mild auto detergent safe for clear coated surfaces. Airstream also recommends waxing a minimum of twice a year. Walbernize Superseal is a product that was designed specifically for Airstream and provides good wax protection; see [Cleaning on page 6-2](#).

4. *Can I use a nylon cover for my Airstream?*

Answer: Airstream does not recommend using any type of cover. The installation and movement of the cover in windy conditions could scratch the clearcoat.

5. *What type of attachments can I install on the rear of my Airstream?*

Answer: Airstream only recommends the installation of a Fiamma bike rack (Airstream part number: 209397) on the rear of trailers.

6. *My main door is hard to open, is this normal?*

Answer: Your main door is designed differently than a flat surface door. The door is over bent in order to apply more pressure at the top and bottom of door for better sealing. Also, on uneven surfaces, the trailer can be in a slight twist that could affect closing. Make sure trailer is as level as possible.

7. *What is a rubber torsion axle?*

Answer: Your trailer has Dexter rubber torsion axles. This type axle has internal rubber cords that provide load carrying capacity verses leaf spring type axles. Reminder - never jack up trailer using rubber torsion axle tubes; see [Axle and Running Gear Assembly on page 6-8](#)

8. *My windows are sticking and don't open easily; what is wrong?*

Answer: Your windows have rubber seals around the edges which in extreme heat and dusty conditions can become sticky. You can help prevent this by regularly cleaning window seals with soapy water and applying a silicone product or Aerospace Protectant 303 to the seals.

9. *The mattress in my Airstream is an odd shape, where can I buy sheets?*

Answer: Airstream has a selection of sheets for your Airstream and can be purchased by calling (937) 596-6111 extension 7400 or 7418. You can also access our store website at <https://www.airstreamsupplycompany.com>.

Index**A**

Air Conditioner 5-23
 Air Conditioner Control Screen 5-18
 Airstream Academy ii
 Alarms 2-4
 Alde 5-24
 Alde System 5-24, 8-18
 Aluminum Wheels 6-2
 Antenna 5-22
 Appliances 5-22
 Awning 5-18, 6-5

B

Batteries
 Battery Charging 5-14
 Battery 5-11, 5-12, 5-26
 Battery Disconnect 5-17
 Battery Disconnect Switch 5-12
 Brakes 7-2, 8-10
 Electronic Brake Controller 7-2
 Proper Electric Brake Use 7-2
 Breakaway Switch 7-3, 8-10
 Breakers 8-3

C

Cable/Satellite and Ethernet Inlet 6-7
 Cable/Satellite Connection 5-22
 Camber 8-10
 Camping 3-7
 Effects Of Prolonged Occupancy 3-9
 Extended Stay 3-8
 Pre-Travel Check List 3-7
 Carbon Monoxide 2-4
 Detector 2-4
 Important Safety Precautions 2-6
 Symptoms of Carbon Monoxide Poisoning 2-7
 Ceiling Vent Fan 5-23
 Charging 5-15
 Chemical Sensitivity 2-3
 Circuit Breaker Protection 5-9
 Circuit Breakers 8-2
 Breaker Test 5-9
 City Power 5-10
 City Water Hookup 6-6
 Cleaning
 Exterior 6-2
 Interior 5-3

Clothesline 5-4
 Coach-Net 3-6
 Control Panel Pushbuttons 5-20
 Converter 5-10
 Converter Operation 5-11
 Cooktop 5-23
 Cordset 6-7

D

Detectors 2-4
 Dinette 5-5
 Door
 Lubrication and Adjustment 8-19
 Main 6-3
 Screen 6-3
 Doormat and Rug Selection 5-4
 Drain and Waste System 5-6, 8-14
 Drain System Cleaning 8-15
 Drain Valves 8-12

E

Electrical 5-8
 7-Way Plug 7-5
 12-Volt System Information 5-11
 City Power 5-10
 Shoreline Power Supply 6-7
 Electrical Diagrams 8-20
 Exhaust Vent 5-24

F

Fan 5-23
 Ceiling and Bath Vent Fan Control Screen 5-19
 FAQs and Answers 8-31
 Filters 5-23, 8-4
 Fire Extinguisher 2-8
 Flooring 5-4
 Floor Plans 4-2
 Formaldehyde 2-3
 Freeze Damage Protection 3-11
 Fresh Water Layouts 8-28
 Fresh Water Tank Draining 8-12
 Front End Protection 6-4
 Furnace 5-24
 Fuses 8-3

G

Gas Regulator 6-11
 GFCI 5-9
 Glycol Levels 8-18
 Gravity Water Fill 6-6

H

HDMI/Ethernet wall port 5-21
 Hitch
 7-Way Plug 7-5
 Hitching Up 7-4
 Measuring Hitch Ball Height 4-5
 Hitch/Coupler 6-8
 Hitching Up 7-4
 Holding Tanks 8-15
 Home Screen 5-16, 5-17

I

Internet 5-22
 Inverter 5-10, 5-17

J

Jack
 Power Jack 6-9, 8-11
 Stabilizing Jacks 3-9
 Tire Changing 8-5
 Jack Locations 8-5

K

Key Switch 5-12

L

Leveling 3-8
 License Plate LED 8-3
 Lighting 8-3
 Lights 5-18, 5-20
 Liquid Petroleum Gas 6-10
 Detector 2-4
 Detector Test 2-5
 Low Voltage 2-5
 Load Distribution 7-5
 Equalizing 7-5
 Loading 7-3
 LPG 5-22, 6-10, 6-11, 6-12, 8-33
 Basic Rules For LPG Safety 2-7
 Detector 2-4
 Fill Valve 6-10
 Port 6-12
 Safety 2-7, 6-12
 Tanks 6-11
 LPG Port 6-12
 Lug Nut Torquing 2-2, 8-9
 Lug-Pattern Sequence 8-9

Index

M

Main Door 6-3
 Lubrication and Adjustment 8-19
Maintenance Schedule 8-2
Micro-Controller Operation 5-15
Microwave 5-25
Modes 5-17
Mold 2-2, 3-5, 3-9
Monitor Panel 5-25
Multiplex System 5-16
MyAirstream App 5-20

O

Outlets/Receptacles 5-10
Overnight Stop 3-8

P

Parts 8-3
Plumbing 5-6
Power Center 5-8
Power Head
 Maintenance 8-11
Power Inlet and Cordset 6-7
Power Jack 6-9, 8-11
Pushbuttons 5-20

R

Receptacles 5-10
Refrigerator 5-26
Restoring Service After Winter
 8-18
Roadside Assistance 3-6
Rug Selection 5-4

S

Safety 2-2
 Controlling Sway or Fishtailing
 7-8
Sanitizing 8-13
Satellite Connection 5-21
Screen Door 6-3
Service 3-6
Shell Protection 6-4
Shoreline Connection 5-15
Shoreline Detection 5-17
Shoreline Power Supply 6-7
Shower, Exterior 6-6
SmartPlug 5-15
SmartPlug Cable/Satellite and
 Ethernet Inlet 6-7
SmartPlug Cordset 6-7

SmartPlug Inlet 6-7
Smoke Alarm 2-4
Solar Panel Wiring 8-27
Sound System 5-21
Spare Tire Carrier 8-9
Specifications 4-4
Sprayer Port 6-6
Stabilizing Jacks 6-9
Step 6-4
 Operation 6-4
Stereo 5-21
Stone Guards 6-4

T

Tank Flush 8-15
Tank Heaters 3-11, 5-17
Tank Levels 5-26
Tanks
 Drain System Cleaning 8-15
 Emptying the Holding Tanks 8-15
 Fresh Water Tanks and Draining
 8-12
Tire Pressure Monitor System 5-17
Tires 8-5
 Tire Changing 8-5
Toe-In 8-10
Toilet 5-7
Touchscreen 5-16
Touch-up 8-4
Towing 2-2
 7-Way Plug 7-5
 Backing Up 7-7
 General Information 7-5
Tow Vehicle 7-2
Tow Vehicle to Trailer Charging
 5-15
Trailer
 Weight 7-4
TV and Audio Component Pairing
 5-21
TV and Sound System 5-21
TV Lift 5-21

U

User Guide Videos ii

V

Vent
 Ceiling and Bath Vent Fan Con-
 trol Screen 5-19
 Exhaust Vent 5-24
Ventilation 2-3
Vinyl Floor 5-4

W

Warranty 3-2
 Obtaining Warranty Service 3-4
Waste Tank Flush 8-15
Wastewater System 3-10
Water Fill 6-6
Water Heater 5-24
 Water Heater Draining 8-13
Water Pump 5-6, 5-17
 Access Locations 8-11
 Strainer Cleaning 8-11
Water System 5-6
Water Tank Air Cushion 8-18
Water Tank Draining 8-15
Weighing Your Trailer 7-4
Weight Distribution 2-2
Wheel Bearing Maintenance 8-9
Windows 8-19
Window Stone Guards 6-4
Winterizing and Storage 8-16
Winter Traveling 3-11

AIRSTREAM®

1001 West Pike Street

P.O. Box 629

Jackson Center, OH. 45334-0629

Phone: (937) 596-6111 Fax: (937) 596-7939

www.airstream.com