

# AIRSTREAM®

Roll With The Best®



 SCAN ME

2025 TOMMY BAHAMA ATLAS

**ATLAS™**

*Tommy Bahama®*

Owner's Manual

## User Guide Videos and Airstream Academy

Scan the QR code on the cover or visit <https://support.airstream.com> to view model-specific User Guide Videos that explore topics discussed in this manual. Visit Airstream Academy at <https://www.airstream.com/academy/> to learn the ins and outs of Airstreaming by exploring videos, articles, and frequently asked questions covering a wide range of popular RV topics.

### **⚠ WARNING**

**Operating, servicing and maintaining a passenger vehicle or off-road vehicle can expose you to chemicals including engine exhaust, carbon monoxide, phthalates, and lead, which are known to the State of California to cause cancer and birth defects or other reproductive harm. To minimize exposure, avoid breathing exhaust, do not idle the engine except as necessary, service your vehicle in a well-ventilated area and wear gloves or wash your hands frequently when servicing your vehicle. For more information go to [www.P65Warnings.ca.gov/passenger-vehicle](http://www.P65Warnings.ca.gov/passenger-vehicle)**

## Disclaimer And Copyright

All information, illustrations and specifications contained in this manual are based on the latest product information available at the time of publication approval. If and when new materials and production techniques are developed that can improve the quality of its product, or material substitutions are necessary due to availability, Airstream reserves the right to make such changes.

Airstream Tommy Bahama Atlas Owner's Manual

©2024 Airstream, Inc. All rights reserved

**Publication Date: June 2024**

**REV# 02**

# AIRSTREAM®

## TABLE OF CONTENTS

|   |      |   |      |
|---|------|---|------|
| INTRODUCTION . . . . .                              | 1-1  | SPRINTER VAN . . . . .                                | 7-1  |
| SAFETY . . . . .                                    | 2-1  | Important Sprinter Information . . . . .              | 7-2  |
| Safety Precautions . . . . .                        | 2-2  | Tires . . . . .                                       | 7-4  |
| Chemical Sensitivity and Ventilation . . . . .      | 2-2  | Changing A Tire . . . . .                             | 7-6  |
| Alarms and Detectors . . . . .                      | 2-3  | Installing and Removing A Wheel . . . . .             | 7-8  |
| Fire Extinguisher . . . . .                         | 2-9  | Tire Rotation . . . . .                               | 7-9  |
| Emergency Exits . . . . .                           | 2-9  | Air Ride Suspension . . . . .                         | 7-10 |
| GENERAL INFORMATION . . . . .                       | 3-1  | DRIVING . . . . .                                     | 8-1  |
| Limited Warranty Policy . . . . .                   | 3-2  | Loading . . . . .                                     | 8-2  |
| Service . . . . .                                   | 3-6  | Safety . . . . .                                      | 8-4  |
| Camping . . . . .                                   | 3-7  | Trailer Towing and Driving Tips . . . . .             | 8-4  |
| FLOOR PLANS AND SPECIFICATIONS . . . . .            | 4-1  | Towing a Trailer . . . . .                            | 8-6  |
| Floor Plans . . . . .                               | 4-2  | Towing Your Touring Coach . . . . .                   | 8-9  |
| Specifications . . . . .                            | 4-3  | Safety Check List . . . . .                           | 8-10 |
| INTERIOR . . . . .                                  | 5-1  | MAINTENANCE . . . . .                                 | 9-1  |
| General Information and Cleaning . . . . .          | 5-3  | Maintenance Schedule . . . . .                        | 9-2  |
| Electrical System Overview . . . . .                | 5-9  | Suggested Maintenance and Replacement Parts . . . . . | 9-3  |
| Electrical System Operation . . . . .               | 5-13 | Tire Care . . . . .                                   | 9-5  |
| Entertainment Systems . . . . .                     | 5-22 | LPG System . . . . .                                  | 9-6  |
| Appliances . . . . .                                | 5-24 | Plumbing . . . . .                                    | 9-7  |
| EXTERIOR . . . . .                                  | 6-1  | Drain and Waste System . . . . .                      | 9-10 |
| Exterior Care . . . . .                             | 6-2  | Winterizing and Storage . . . . .                     | 9-12 |
| Waxes and Polishes . . . . .                        | 6-2  | Electrical Diagrams . . . . .                         | 9-17 |
| How to Care for Your Touring Coach Finish . . . . . | 6-2  | Fresh Water Layout . . . . .                          | 9-31 |
| Roadside Exterior Components . . . . .              | 6-4  | FAQs and Answers . . . . .                            | 9-32 |
| Curbside Exterior Components . . . . .              | 6-5  |   |      |
| Exterior Features . . . . .                         | 6-6  |   |      |
| Exterior Doors . . . . .                            | 6-9  |   |      |
| Awning . . . . .                                    | 6-10 |   |      |
| Hydraulic Leveling System . . . . .                 | 6-11 |   |      |
| Hitch Cover . . . . .                               | 6-12 |   |      |



# AIRSTREAM®

## Section 1 INTRODUCTION

The Owner's Manual for your new Airstream Atlas is designed to respond to the most frequent inquiries regarding the operation, function, and care of the many systems that enhance your travel and camping experience.

The Airstream Atlas is integrated into a Sprinter Van, designed and manufactured by Mercedes-Benz. Operation of the Sprinter, its engine, power train, and other related components are discussed in the Mercedes-Benz Sprinter Operator's Manual and other literature provided by Mercedes-Benz. As a point of reference, those systems discussed in the Sprinter literature are warranted by Mercedes-Benz or their suppliers.

Airstream realizes our customers possess varying degrees of expertise in the area of maintaining and repairing the appliances in their touring coach. For this reason, the service and trouble-shooting information found in this manual is directed toward those with average mechanical skills. We also realize you may be more familiar in one area than you are in another. Only you know your capabilities and limitations.

We want you to use this manual, and hope you will find the information contained in it helpful; however, should you ever feel you may be "getting in over your head," please see your dealer to have the repairs made.

The operation and care of component parts such as, refrigerator, furnace, water heater and others are briefly explained in this manual.

All information, illustrations, and specifications contained in this manual are based on the latest product information available at the time of publication approval. Airstream reserves the right to make changes if and when new materials and/or production techniques are developed that can improve the quality of its product, or when material substitutions are necessary due to availability.

Optional items may be available on all, or particular models. Additionally, some optional items can only be included during the manufacturing phase and cannot later be added to the touring coach. The inclusion of optional items information in this manual does not imply or suggest the availability, application, suitability, or inclusion for any specific unit.

### NOTE

**Your Mercedes-Benz Sprinter Van Operator's and Warranty Manuals contain important cautions, warnings, operational, and warranty information on the Sprinter and its components. All information in the Sprinter manual should be reviewed and followed for your safety. The Airstream Owner's Manual may provide additional information and tips on the use of the van as a touring coach; however, no information in the Airstream manual should be interpreted as advice or directions to disregard or void the warnings, cautions, or other information contained in the Sprinter's manuals.**

Airstream uses the  safety alert symbol and signal words Danger, Warning, and Caution to alert you to potential personal injury hazards. Obey all safety messages that follow this symbol to avoid possible injury or death. The following are examples of each type of signal word, safety message, and information message found throughout this manual.

## **DANGER**

Indicates a hazardous situation which, if not avoided, will result in death or serious injury.

## **WARNING**

Indicates a hazardous situation which, if not avoided, could result in death or serious injury.

## **CAUTION**

Indicates a hazardous situation which, if not avoided, could result in minor or moderate injury.

## **NOTICE**

Indicates a potential situation which, if not avoided, may result in damage to your Airstream. Addresses practices not related to personal injury.

## **NOTE**

Provides noteworthy information and tips about your Airstream.

# AIRSTREAM®

## Section 2 SAFETY

|  |     |  |     |
|--|-----|--|-----|
| SAFETY PRECAUTIONS . . . . .                   | 2-2 | ALARMS AND DETECTORS . . . . .   | 2-3 |
| Weight Distribution . . . . .                  | 2-2 | Smoke Alarm/Carbon Monoxide Detector . . . . .                                 | 2-3 |
| Tire Safety . . . . .                          | 2-2 | Smoke Alarm . . . . .  | 2-3 |
| Appliance and Equipment Safety . . . . .       | 2-2 | Batteries Low . . . . .  | 2-4 |
| Mold . . . . .                                 | 2-2 | This Carbon Monoxide Detector Is Not . . . . .                                 | 2-4 |
| CHEMICAL SENSITIVITY AND VENTILATION . . . . . | 2-2 | Important Safety Precautions . . . . .   | 2-4 |
| Chemical Sensitivity . . . . .                 | 2-2 | What Is Carbon Monoxide . . . . .  | 2-5 |
| Formaldehyde . . . . .                         | 2-2 | Conditions that can result in potentially<br>dangerous CO situations . . . . . | 2-5 |
| Ventilation . . . . .                          | 2-3 | Symptoms of Carbon Monoxide Poisoning . . . . .                                | 2-5 |
| Do Not Smoke . . . . .                         | 2-3 | Regular Maintenance of Smoke/CO Detector . . . . .                             | 2-6 |
| Medical Advice . . . . .                       | 2-3 | Testing the Smoke/CO Detector . . . . .  | 2-6 |
|  |     | Liquid Propane Gas (LPG)/Carbon<br>Monoxide (CO) Detector . . . . .            | 2-6 |
|  |     | Low Voltage . . . . .  | 2-6 |
|  |     | Detector Test . . . . .  | 2-7 |
|  |     | Basic LPG Safety Information . . . . .   | 2-7 |
|  |     | If you smell gas . . . . .   | 2-7 |
|  |     | Basic Generator Safety Information . . . . .                                   | 2-8 |
|  |     | FIRE EXTINGUISHER . . . . .  | 2-9 |
|  |     | EMERGENCY EXITS . . . . .  | 2-9 |
|  |     | Safety . . . . .   | 2-9 |

## Safety Precautions

Many things can be construed as safety related, but the most important is your common sense. If you are careless with matches, cigarettes, flammable material, or any other hazardous material, you surely realize your potential for accidents is greatly increased.

You will find many safety recommendations in this section and throughout the manual. The following recommendations are the ones we consider to be the most important.

### Weight Distribution

Touring coach's have fresh water and waste water tanks, a water heater, and storage areas. It gives you great flexibility in loading. If you want to load down all the storage compartments, the amount of fluids may have to be reduced. It is a trade off so plan wisely. Distribute your additional cargo as evenly as possible with the heaviest objects located as low as possible. For detailed information on loading and weight distribution, [see Loading on page 8-2](#).

### Tire Safety

Properly maintained tires improve the steering, stopping, traction, and load-carrying capability of your vehicle; [see Tire Care on page 9-5](#)

### Appliance and Equipment Safety

The stove, heating and hot water systems, and generator typically operate on liquefied petroleum (LP) gas. LP gas is flammable and is contained under high pressure. Improper use may result in a fire and possible explosion. Follow all instructions and warnings in this manual as well as those in each of the appliance and equipment manufacturer's manuals; [see Basic LPG Safety Information on page 2-7](#) and [see LPG System on page 9-6](#).

Do not operate the generator or the heating and hot water system in an enclosed building or in a partly enclosed area, such as a garage. Follow all instructions and warnings in this manual as well as those in each of the equipment manufacturer's manuals; [see Basic Generator Safety Information on page 2-8](#) and [see Generator on page 5-16](#).

### Mold

Mold and mold spores exist throughout indoor and outdoor environments. There is no practical way to eliminate all mold and mold spores in the indoor environment; however, the way to control indoor mold growth is to control moisture; [see What factors contribute to mold growth on page 3-10](#).

## Chemical Sensitivity and Ventilation

### Chemical Sensitivity

Immediately after the purchase of your new recreational vehicle and sometimes after it has been closed up for an extended period of time, you may notice a strong odor and/or experience a chemical sensitivity. This is not a defect in your recreational vehicle. Like your home, there are many different products used in the construction of recreational vehicles, such as carpet, linoleum, plywood, insulation, upholstery, etc. Formaldehyde is also the by-product of combustion and numerous household products, such as some paints, coatings, and cosmetics. However, recreational vehicles are much smaller than your home and therefore, the exchange of air inside a recreational vehicle is significantly less than in a home. These products, when new or when exposed to elevated temperatures and/or humidity, may off-gas different chemicals, including formaldehyde. This off-gassing, in combination with the minimal air exchange, may cause you to experience irritation of the eyes, nose, and throat, as well as sometimes headache, nausea, and a variety of asthma-like symptoms. Elderly persons and young children, as well as anyone with a history of asthma, allergies, or lung problems, may be more susceptible to the effects of off-gassing.

### Formaldehyde

Formaldehyde is a naturally occurring substance and is an important chemical used widely by industries to manufacture building materials and numerous household products. It is also a by-product of combustion and certain other natural processes. Thus, it may be present inside the touring coach. Ventilation of the unit normally reduces the exposure to a comfortable level.

Trace levels of formaldehyde are released from smoking, cooking, use of soaps and detergents, such as carpet shampoos and cosmetics, and many other household products. Some people are very sensitive to formaldehyde while others may not have any reaction to the same levels of formaldehyde. Amounts released decrease over time.

Your Airstream Atlas was manufactured using low formaldehyde-emitting (LFE) wood products, the use of which is typical in the recreation vehicle industry. Formaldehyde has an important role in the adhesives used to bind wood products used in recreation vehicles. The wood products in your coach are designed to emit formaldehyde at or lower than industry guidelines and should not produce symptoms in most individuals.



While LFE wood products typically do not emit formaldehyde at a level that would cause symptoms in most individuals, it is possible, though not likely, for symptoms to occur when the touring coach is not properly ventilated. Ventilation is an essential requirement for touring coach use for many reasons. Any effects of formaldehyde can be greatly reduced by actions such as opening windows, opening roof vents, running the air conditioner, or some combination thereof. In addition, the emission of formaldehyde by these products naturally decreases rapidly over time.

Airstream strongly suggests you take measures to properly ventilate your touring coach on a regular basis. If you have any questions with respect to proper ventilation of your touring coach, please do not hesitate to contact your dealer or Airstream.

### Ventilation

To reduce or lessen exposure to chemicals from off-gassing, it is of utmost importance that you ventilate your recreational vehicle. Ventilation should occur frequently after purchase and at times when the temperatures and humidity are elevated. Remember, off-gassing is accelerated by heat and humidity. Open windows, exhaust vents, and doors. Operate ceiling and/or other fans, roof AC, and use a fan to force stale air out and bring fresh air in. Decreasing the flow of air by sealing the recreational vehicle increases the formaldehyde level in the vehicle's indoor air.

### Do Not Smoke

It is recommended you do not smoke inside your recreational vehicle. In addition to causing damage to your recreational vehicle, tobacco smoke releases formaldehyde and other toxic chemicals.

### Medical Advice

Questions regarding the effects of formaldehyde on your health should be submitted to your doctor or local health department.

## Alarms and Detectors

Parts of this section on the combination Smoke/Carbon Monoxide Detector are a reprint of the manual included with the device and provided to you in the Airstream owner's packet.

Carefully read and understand the contents of the provided instruction manual before using the detector. Store the manual in a safe place for future reference. Pay particular attention to the safety warnings. Pass the manual on to any subsequent users of the alarm.

If you have not received the manual, contact your dealership to obtain one, or contact Airstream Customer Relations at 937-596-6111.

### **⚠ WARNING**

**Dangers, Warnings, and Cautions alert you to important operating instructions or to potentially hazardous situations. Pay special attention to these items.**

### Smoke Alarm/Carbon Monoxide Detector



#### Smoke Alarm

**Power/Smoke LED:** Flashes RED

**Horn:** 3 BEEPS, pause, 3 BEEPS, pause

**CO LED:** Off

#### Carbon Monoxide Alarm

**CO LED:** Flashes RED

**Horn:** 4 BEEPS, pause, 4 BEEPS, pause

**Power/Smoke LED:** Off

### **⚠ WARNING**

**If either alarm sounds, exit immediately and call the Fire Department. In the event of a carbon monoxide alarm, exit immediately and move everyone to a source of fresh air. Do not remove the batteries.**

## Batteries Low

The Smoke/Carbon Monoxide Detector will “chirp” once a minute for at least 30 days when the batteries are weak. The battery must immediately be replaced with a fresh one. The unit may beep briefly when you install the batteries. This is normal. The GREEN light flashes about every 60 seconds when the unit is receiving battery power.

### **⚠ WARNING**

Smoke/Carbon Monoxide detectors have a limited life. The unit should be replaced immediately if it is not operating properly. You should always replace an alarm after 5 years from the date of purchase. Write the purchase date on the space provided on the back of unit.

### **⚠ WARNING**

This product is intended for use in ordinary, indoor locations of family living units. It is not designed to measure compliance with occupational safety and health administration (OSHA) commercial or industrial standards. Individuals who are at special risk from Carbon Monoxide exposure by reason of age, pregnancy, or medical condition may consider using warning devices which provide audible and visual signals for Carbon Monoxide concentration under 30 ppm. If in doubt, consult your medical practitioner.

### **⚠ WARNING**

Activation of your Carbon Monoxide alarm’s audible horn indicates the presence of Carbon Monoxide that can kill you. Leave the area immediately!

## This Carbon Monoxide Detector Is Not

- Designed to detect any gas other than Carbon Monoxide.
- To be seen as a substitute for the proper servicing of fuel-burning appliances.
- To be used on an intermittent basis, or as a portable alarm for spillage of combustion products from fuel-burning appliances.

### **⚠ WARNING**

This Carbon Monoxide detector is designed for indoor use only. Do not expose to rain or moisture. Do not knock or drop the alarm. Do not open or tamper with the alarm as this could cause malfunction. The detector will not protect against the risk of Carbon Monoxide poisoning when the batteries are dead or missing. The alarm will only indicate the presence of Carbon Monoxide gas at the sensor. Carbon Monoxide gas may be present in other areas.

## Important Safety Precautions

- Ideally, it is recommended that a Carbon Monoxide detector should be installed in or near every room that has a fuel burning appliance such as any room heaters, water heaters, cookers, grills, etc.
- Ensure that the alarm horn can be heard by all those who are intended to hear it. Seek medical help if it is suspected that a user of the RV is suffering from Carbon Monoxide poisoning.
- If the alarm sounds, make sure to investigate the problem. Ignoring the alarm may result in sickness, injury or death. (CO may be present even if nothing is seen or smelled by the user.)
- Room spaces should be well ventilated when household cleaning supplies are used as these may cause a false alarm.
- Alarm should be tested once per week. If further details are required, which do not appear in this manual, contact BRK Brands Inc. First Alert.

## What Is Carbon Monoxide

Carbon Monoxide (CO) is a highly poisonous gas that is released when fuels are burned. It is invisible, has no smell, and is therefore very difficult to detect with the human senses. Under normal conditions, in a room where fuel-burning appliances are well maintained and correctly ventilated, the amount of CO released into the room by appliances is not dangerous.

These fuels include wood, coal, charcoal, oil, natural gas, gasoline, diesel fuel, kerosene, and propane. Common appliances are often sources of CO. If they are not properly maintained, are improperly ventilated, or malfunction, CO levels can rise quickly. CO is a real danger in air-tight vehicles with added insulation, sealed windows, and other weatherproofing that can trap CO inside.

### **Conditions that can result in potentially dangerous CO situations**

1. Excessive spillage or reverse-venting of fuel-burning appliances caused by outdoor conditions, such as:
  - Wind direction and/or velocity, including high gusts of wind.
  - Heavy air in the vent pipes (cold/humid air with extended periods between cycles).
  - Negative pressure differential resulting from use of exhaust fans.
  - Simultaneous operation of several fuel-burning appliances competing for limited internal air.
  - Vent-pipe connections vibrating loose from clothes dryers, furnaces, or water heaters.
  - Obstructions in or unconventional vent-pipe designs which can amplify the above situations.
2. Extended use of un-vented fuel burning devices.
3. Temperature increase that can trap exhaust gases near the ground.

## Symptoms of Carbon Monoxide Poisoning

- Mild Exposure - Slight headache, nausea, vomiting, fatigue (flu-like symptoms).
- Medium Exposure - Throbbing headache, drowsiness, confusion, fast heart rate.
- Extreme Exposure - Convulsions, unconsciousness, heart and lung failure. Exposure to CO can cause brain damage and/or death.

### **⚠ WARNING**

**The Smoke/CO detector is shipped with batteries deactivated. Ask your dealer to activate batteries or activate batteries immediately upon delivery. Failure to follow this warning will remove your protection.**

### **⚠ DANGER**

**Many causes of reported CARBON MONOXIDE POISONING indicate that while victims are aware that they are not well, they become so disoriented that they are unable to save themselves by either exiting the area or calling for assistance. Also young children and pets may be the first to be affected.**

### **⚠ WARNING**

**Test Units in your touring coach after the vehicle has been in storage, before each trip, and at least once a week while in use. If the alarm ever fails to test correctly, have it replaced immediately. If the alarm is not working properly, it cannot alert you to a problem. Failure to test units used in RVs as described may remove your protection.**

## Regular Maintenance of Smoke/CO Detector

The Smoke/CO detector has been designed to be as maintenance-free as possible, but there are a few simple things you must do to keep it working properly. Use replacement batteries as indicated in the manual included with the device and provided to you in the Airstream owner's packet. The unit may not operate properly with other batteries. Never use rechargeable batteries since they may not provide a constant charge.

### Testing the Smoke/CO Detector

PRESS and HOLD the TEST/SILENCE button 3-5 seconds until the unit starts to alarm. During testing, you will see and hear the following sequence:

- The Horn will sound 3 BEEPS, pause, 3 BEEPS. The Power/Smoke LED flashes Red and the CO LED will be Off.
- Next the Horn will sound 4 BEEPS, pause, 4 BEEPS. The Power/Smoke LED will be Off and the CO LED flashes Red.
- Test it at least once a week.
- Clean the Smoke/CO Alarm at least once a month: gently vacuum the outside of the alarm using your household vacuum's soft brush attachment. A can of clean, compressed air (sold at computer or office supply stores) may also be used. Follow manufacturer instructions for use. Never use water, cleaners, or solvents, since they may damage the unit.
- If the alarm becomes contaminated by excessive dirt, dust, and/or grime, and cannot be cleaned to avoid unwanted alarms, replace the unit immediately.

### **⚠ WARNING**

**The battery door will resist closing unless batteries are installed. This warns you that the unit will not operate without batteries.**

### **⚠ DANGER**

**Carbon Monoxide is poisonous and can cause confusion, unconsciousness, and death. Follow all instructions, cautions, and warnings in this section and the generator operator's manual.**

### **⚠ WARNING**

**NEVER ignore any alarm. Failure to respond can result in injury or death. The Silence Features are for your convenience only and will not correct a problem. Always check your touring coach for a potential problem after any alarm. Failure to do so can result in injury or death.**

## Liquid Propane Gas (LPG)/Carbon Monoxide (CO) Detector



This detector has a five-year life; see end-of-life notification in the detectors manual. Please read the entire detector manual before operating the unit.

The LPG/CO detector is located in the galley area. LPG is a mixture of gases produced and sold commercially as a fuel for heating and cooking appliances. LPG is highly flammable and, as a result, can be explosive if ignited under certain circumstances. LPG is heavier than air and, if confined in a closed space, will accumulate close to the floor. The LPG/CO detector is designed to alarm when propane gas exceeds 10% of the lower-explosive-limit for more than 30 seconds or if CO gas reaches unsafe levels. When propane gas is detected the horn will sound with constant beeps and the red LED will be on. If CO gas is detected the horn will sound with 4 rapid chirps followed by a 4 second pause and the red LED will flash rapidly.

Your LPG/CO detector is wired directly to your touring coach battery and incorporates a 1-amp, in-line fuse. It has no internal battery backup. In normal stand-by mode, the LED indicator will be green.

### **Low Voltage**

The operating voltage for the detector is 12 VDC. The actual voltage supplied to the detector in a recreational vehicle may drop below the minimum 8 VDC. The detector provides the user with a low voltage warning before reaching that level and will provide additional distinct, clear warnings and alarms after the 8 VDC

level is reached. However, if available power supplied to the unit is below the operating voltage of 8 VDC, the detector will not detect gas or provide protection against dangerous levels of LPG.

## **⚠ WARNING**

**If the low voltage warning sounds, the detector will need to be reset by disconnecting the battery, before normal operation will occur.**

### **Detector Test**

If the Silence/Test button is pressed while in normal operation, the alarm will perform a self test of the CO sensor, propane sensor and battery voltage. It is recommended to perform a self test weekly, after power up from storage, and before each trip. If the self test passes, the alarm will perform 2 cycles of the CO horn pattern (4 rapid chirps followed by a 4 second pause), followed by 2 cycles of the propane horn pattern (constantly beeping).

## **⚠ WARNING**

**Activation of this detector indicates the possible presence of LPG, which can cause an explosion and/or fire, causing serious injury or death. This normally indicates a leak in the LPG installation or an LPG appliance. Extinguish all open flames, open your windows and door, and evacuate the unit immediately. Do not activate any electrical switch. Turn off the LPG using the remote shut off switch. Do not re-enter your unit until a qualified repair technician has corrected the problem and certified the system as safe.**

## **NOTICE**

It is not recommended that the detector be disconnected from the battery during periods of storage. There is a small heater on the sensor of the device that burns away impurities in the air during periods of normal use. During periods when power is interrupted, impurities can build up on the sensor. When power is returned to the detector, the detector alarm may activate until the impurities are burned off. This could take a number of hours, during which time the alarm will be constantly on.

## **⚠ WARNING**

**Have a qualified technician check your LPG system annually or if you detect any signs of leaks or malfunctions.**

## **NOTE**

**For additional LPG warnings and safety information, see [Section 5](#) and [Section 6](#).**

### **Basic LPG Safety Information**

Unlike homes, the amount of oxygen supply is limited due to the size of the recreational vehicle, and proper ventilation when using appliances will avoid dangers of asphyxiation. Portable fuel burning equipment, including wood and charcoal grills and stoves, must not be used inside the recreational vehicle.

## **⚠ DANGER**

**The use of portable fuel burning equipment inside a recreational vehicle may cause fires or asphyxiation. DO NOT use cooking appliances or portable gas heaters for comfort heating. Before operation, open overhead vent or turn on exhaust fan and open a window.**

A Warning Label has been located near the LP gas container. This label reads: **DO NOT FILL CONTAINER(S) TO MORE THAN 80% PERCENT OF CAPACITY.** A properly filled container will contain approximately 80% of its volume as liquid LP gas.

## **⚠ DANGER**

**Overfilling the LP gas container to more than 80% of capacity can result in uncontrolled gas flow that can cause a fire or explosion.**

## **⚠ DANGER**

**DO NOT store LP containers within vehicle. LP containers are equipped with safety devices that vent gas should the pressure become excessive.**

### **If you smell gas**

- Extinguish any open flames, pilot lights and all smoking materials.
- Do not touch electrical switches.
- Shut off the gas supply using the remote shut off switch.
- Open doors and other ventilating openings.
- Leave the area until odor clears.
- Have the gas system checked and leakage source corrected before using again.

LP gas regulators must always be installed with the diaphragm vent facing downward. Regulators that are not in compartments have been equipped with a protective cover. Make sure that regulator vent faces downward and that cover is kept in place to minimize vent blockage that could result in excessive gas pressure causing a fire or explosion.

## **⚠ WARNING**

**The regulator vent must face downward. Vent blockage could result in excessive gas pressure causing a fire or explosion.**

The regulator at the LP tank is under a gray, plastic cover. The protective cover helps to keep the vent on the regulator from being clogged by wasps or ice, but the regulator should be checked regularly to make sure the vent remains clear.

## **⚠ WARNING**

**Check vent each time tank is filled to make sure it is clear of obstructions. Do not attempt to seal the regulator cover.**

## **⚠ WARNING**

**Have a qualified technician check your LP Gas system annually or if you have any signs of leaks or malfunctions.**

## **Basic Generator Safety Information**

1. Never sleep in the vehicle with the generator running without ensuring the Carbon Monoxide detector is working. Primary protection against inhaling Carbon Monoxide is daily (every eight hour) inspection for visible and audible generator exhaust system leaks.
2. DO NOT operate the generator in an enclosed building or in a partly enclosed area such as a garage.
3. Review the safety precautions for fuel and exhaust fumes in the generator manual.
4. DO NOT operate the generator when the recreation vehicle is parked in high grass or brush. Heat from the exhaust could cause a fire in dry conditions.
5. DO NOT simultaneously operate generator and a ventilator which could result in the entry of exhaust gas. When exhaust ventilators are used, we recommend that a window on the opposite side of the unit "upwind" of exhaust gases be opened to provide cross ventilation.
6. When parked, orient the vehicle so that the wind will carry the exhaust away from the vehicle. DO NOT open nearby windows, ventilators, or doors into the passenger compartment, particularly those which can be "down wind", even part of the time.
7. DO NOT operate the generator when parked in close proximity to vegetation, snow, buildings, vehicles, or any other object that could deflect the exhaust under or into the vehicle.
8. DO NOT touch the generator when running, or immediately after shutting off. Heat from the generator can cause burns. Allow the generator to cool before attempting maintenance or service.

## **⚠ DANGER**

**Your touring coach is equipped with an Automatic Generator Start System. Exposure to carbon monoxide, moving parts, and electricity hazards are possible due to unexpected automatic starting.**

## **NOTE**

**The generator is located in the exterior curbside rear compartment of the touring coach.**

## Fire Extinguisher



The fire extinguisher should be checked for charge on a regular basis. Make sure your family knows how to release the extinguisher storage bracket and how to properly operate the extinguisher. Check with your local fire department for professional advice on its operation and use if you find the directions on the extinguisher unclear. They will be able and willing to assist you and your family.

### **⚠ WARNING**

Read the directions carefully on the fire extinguisher. If there is any doubt on the operation you and your family should practice, then replace or recharge the extinguisher. You will find your local fire department will be happy to assist you and answer any questions.

### **⚠ WARNING**

Do not smoke inside the touring coach. Keep matches out of reach of small children. Do not bring flammable liquids inside the RV or clean with flammable materials. Keep flammable materials away from open flames. We have all heard these warnings many times, but they are still among the leading causes of fires.

## Emergency Exits

There are three avenues of escape from the touring coach in the event of an emergency, the driver's door, the passenger door, and the side entry door. As always, safety should be one of your top priorities. Make sure you and everyone traveling with you can operate these doors and exit rapidly without light. A little planning and a quick practice session at each camping site is well worth the time it may take. Remember the side entry door steps take a few seconds to extend once the door is opened. If power is unavailable the step may not extend at all. Always look before exiting the side entry door.

### **Safety**

As always, safety should be a top priority. Ensure that you, and everyone traveling with you, can quickly operate the main door in the dark. Plan for other means of escape in case the designated exit is blocked.

### **⚠ DANGER**

At each campsite, make sure you have not parked in such a manner as to block the operation of the doors or the escape avenues by being too close to trees, fences, or other impediments. Scenic views are one reason for traveling, but do not park so the beautiful lake or steep cliff is just outside your doors. Do not block access to the doors from the inside or outside of the vehicle.





# AIRSTREAM®

## Section 3 GENERAL INFORMATION

|  |     |   |      |
|--|-----|---|------|
| LIMITED WARRANTY POLICY . . . . .  | 3-2 | CAMPING . . . . .                                 | 3-7  |
| This Limited Warranty Covers . . . . .   | 3-2 | Suggested Pre-Travel Check List . . . . .         | 3-7  |
| Coverage Ends . . . . .  | 3-2 | Exterior . . . . .                                | 3-7  |
| Limitation Of Implied Warranties . . . . .   | 3-2 | Interior . . . . .                                | 3-7  |
| Disclaimer Of Incidental And<br>Consequential Damages . . . . .                        | 3-2 | Touring Coach Equipment and Accessories           | 3-7  |
| Repair Remedy . . . . .  | 3-2 | Motoring Essentials . . . . .                     | 3-7  |
| Back-Up Remedy . . . . .   | 3-3 | Overnight Stop . . . . .                          | 3-8  |
| What Is Not Covered . . . . .  | 3-3 | Overnight or Weekend Trips . . . . .              | 3-8  |
| Obtaining Warranty Service . . . . .   | 3-4 | Longer Trips . . . . .                            | 3-8  |
| Consumer Arbitration Program . . . . .   | 3-5 | Extended Stay . . . . .                           | 3-8  |
| Events That Discharge Airstream's<br>Obligations Under This Limited Warranty . . . . . | 3-5 | Leveling . . . . .                                | 3-9  |
| Legal Remedies . . . . .   | 3-5 | Effects of Prolonged Occupancy . . . . .          | 3-9  |
| Airstream Limited Warranty Excludes . . . . .  | 3-5 | About Molds . . . . .                             | 3-10 |
| Normal Wear . . . . .  | 3-5 | What are molds . . . . .                          | 3-10 |
| Accident . . . . .   | 3-5 | What factors contribute to mold growth . . . . .  | 3-10 |
| Abuse . . . . .  | 3-5 | How can mold growth be inhibited . . . . .        | 3-10 |
| Exposure . . . . .   | 3-5 | Waste Water System. . . . .                       | 3-10 |
| Overload . . . . .   | 3-5 | Things Not to Put into Toilet or Drains . . . . . | 3-10 |
| Chemical Gassing . . . . .   | 3-5 | Drain System . . . . .                            | 3-10 |
| Sprinter Van . . . . .   | 3-6 | Winter Traveling . . . . .                        | 3-11 |
| SERVICE . . . . .  | 3-6 | Heated Tanks . . . . .                            | 3-11 |
| Coach-Net® Roadside Assistance . . . . .   | 3-6 |   |      |
| Service Centers . . . . .  | 3-6 |   |      |
| Reporting Safety Defects . . . . .   | 3-7 |   |      |

## Limited Warranty Policy

### This Limited Warranty Covers

(i) The first retail owner and any subsequent owners  
(ii) ONLY those portions of a NEW motorhome not excluded under the section “What is Not Covered”, when sold by an authorized dealership and used for its intended purpose of recreational travel and camping; and, (iii) ONLY defects in workmanship performed and/or materials used to assemble those portions of your motorhome not excluded under the section “What is Not Covered”. “Defect” means the failure of the workmanship performed and/or materials used to conform with the design and manufacturing specification and tolerances of Airstream. The Limited Warranty is transferable and the subsequent owner’s warranty coverage period shall be the unexpired balance of the original warranty coverage period. A completed copy of the Warranty Transfer Form must be submitted to Airstream at the time of resale.

When you request and accept the performance of warranty repairs under the terms of this Limited Warranty, you are accepting all terms of this Limited Warranty, including by way of example, warranty limitations and disclaimers, the forum selection clause and the clause reducing the time period when suit must be filed for breach.

If any term of condition in this limited warranty conflicts with your state’s Uniform Commercial Code (“UCC”) as interpreted by courts within your state, the provisions of your state’s UCC are varied as allowed for by USS 1-302.

### Coverage Ends

36 months after the first retail owner first takes delivery of the motorhome from an authorized dealership or after the odometer reaches 36,000 miles, whichever occurs first. Any action for breach of this warranty or any implied warranties must be commenced not more than 37 months after breach. Some states do not allow the reduction of the time when a breach of warranty claim must be commenced, so the reduction in time when a breach of warranty claim must be commenced may not apply to you.

## Limitation Of Implied Warranties

Implied warranties arising under applicable law, if any, including but not limited to implied warranties of merchantability or fitness for a particular purpose, are hereby limited in duration to the term of this limited warranty and are limited in scope of coverage to those portions of the motorhome covered by this limited warranty. There are no express warranties or any implied warranties of merchantability on those portions of the motorhome excluded from coverage. There is no warranty of any nature made by airstream beyond that contained in this limited warranty. No person has authority to enlarge, amend or modify this limited warranty. The dealer is not Airstream’s agent. Airstream is not responsible for any undertaking, representation or warranty made by any dealer or others beyond those expressly set forth within this limited warranty. Some states do not allow limitations on how long an implied warranty lasts, so the above limitations may not apply to you.

## Disclaimer Of Incidental And Consequential Damages

Airstream disclaims any and all incidental and consequential damages, including but not limited to expenses such as transportation to and from dealerships and Airstream repair facilities, loss of time, loss of pay, loss of use, inconvenience, commercial loss (including but not limited to lost profits), towing charges, bus fares, vehicle rental, service call charges, gasoline expenses, incidental charges such as telephone calls and facsimile transmissions, and expenses for lodging and moisture damage such as mold and mildew as well as rust and corrosion. This disclaimer is independent of any failure of the essential purpose of any warranties provided with the motorhome, and shall survive any determination that a warranty failed of its essential purpose. Some states do not allow the exclusion or limitation of incidental or consequential damages, so the above limitation or exclusion may not apply to you.

## Repair Remedy

Airstream’s sole and exclusive obligation is to repair any covered defects discovered within the warranty coverage period if: (1) within 10 days of your discovery of a defect you notify Airstream OR an authorized dealership of the defect; AND (2) you deliver your Motorhome to Airstream OR an authorized dealership at your cost and expense.

## Back-Up Remedy

If the primary repair remedy fails to successfully cure any defect after a reasonable number of repair attempts, your sole and exclusive remedy shall be to have Airstream pay an independent service shop of your choice to perform repairs to the defect OR if the defect is incurable, have Airstream pay diminution in value damages. The repair remedy and the back-up remedy must both be exhausted and these remedies must fail to fulfill their essential purpose before you can seek other legal or equitable remedies for breach of this express warranty or for breach of any implied warranty. This limited warranty is not a warranty that promises or extends to future performance because the warranty does not make a representation on how your motorhome will perform in the future but instead represents only what the remedy will be if a defect exists.

Unless prohibited by state law, repairs will not extend the time when you must commence a breach of warranty claim and shall not extend the warranty coverage period. Any performance of repairs after the warranty coverage ends OR any performance of repairs to those portions of your motorhome excluded from coverage shall be considered "good will" repairs. Warranty repairs should be expected. Airstream may use new and/or remanufactured parts and/or components of substantially equal quality to complete a repair. Damage to interior or exterior surfaces, trim, upholstery and other appearance items may occur at the factory during assembly, during delivery of the motorhome to your selling dealer or on the selling dealer's lot. Normally, any damage is detected and corrected at the factory or by the selling dealer during the inspection process. If you discover any damage when you take delivery of your motorhome, you MUST notify your dealer OR Airstream within 10 days of the date of purchase to have damage repaired at no cost to you. Minor adjustments, such as adjustments to the interior or exterior doors, drawers, latches will be performed at no cost to you by your selling dealer during the first 90 days of warranty coverage; thereafter, such adjustments are your exclusive responsibility as normal maintenance.

## What Is Not Covered

1. Tires, batteries, lithium power system, stereo, television, range/stove, furnace, refrigerator, air conditioner, toilet, water heater, microwave, generator, glass breakage, and other materials, parts and components warranted by persons or entities other than Airstream. Please refer to the warranties of component manufacturers for terms and conditions of coverage;
2. Accessories and equipment that are working as designed, but which you are unhappy because of the design
3. Any part or component of the vehicle that was not manufactured or installed by Airstream;
4. Normal deterioration due to wear or exposure, including but not limited to upholstery, flooring rust, corrosion, oxidation, and cosmetic blemishes;
5. Normal maintenance and service items, including but not limited to light bulbs, fuses, lubricants, sealants and seals, door adjustments, and awning tension;
6. After-market equipment or accessories installed on the vehicle after completion of manufacture by Airstream, or any defects or damage caused by such items;
7. Vehicles not purchased through an authorized dealer of Airstream and vehicles purchased directly or indirectly through auction, salvage, repossession, or other non-customary sale means;
8. Any motorhome used other than for temporary recreation purposes, including, but not limited to, use of the motorhome for residential, rental, business and commercial purpose or any motorhome purchased by, registered by, or titled in the name of a business association (such as any LLC, corporation, or partnership). If the motorhome owner or user files a tax form claiming a business or commercial tax benefit or income related to the motorhome, it shall be irrefutable that the motorhome has been used for rental, commercial or business purposes.

## General Information

---

9. Defects or damage caused by, in whole or in part, or in any way related to: Accidents, misuse (including off-road use), or negligence; Failure to comply with the instructions set forth in any owner's manual provided with the vehicle; Alteration or modification of the vehicle except such alterations or modifications approved in writing by Airstream; Acts of God or other environmental conditions, such as lightning, hail, salt causing rust, or other chemicals in the atmosphere; De-icing agents or other chemicals applied to the vehicle; Failure to properly maintain or service the vehicle, including but not limited to the maintenance of lubricants, sealants, and seals; Condensation and the results of condensation including water damage and the growth of mold or mildew. Mold and mildew are natural growths given certain environmental conditions and are not covered by the terms of this Limited Warranty; The addition of weight to the vehicle that causes the total weight to exceed applicable vehicle weight ratings, or addition of weight causing improper distribution of the weight of the vehicle; Failure to seek and obtain repairs in a timely manner; Failure to use reasonable efforts to mitigate damage caused by defects' Failure to properly ventilate the vehicle; Improper electric power supply or improper vehicle hookup to other facilities; and, Acts or omissions of any person or entity other than Airstream. (Note: An irrefutable presumption arises that the motorhome has been used for commercial and/or business purposes if the motorhome owner or user files a tax form claiming any business or commercial tax benefit related to the motorhome, or if the motorhome is purchased, registered or titled in a business name.)

### Obtaining Warranty Service

In order to obtain warranty service under this Limited Warranty, the owner must do all of the following:

1. Owner and dealer representative must complete and return the Customer Performance Checkout within 10 days from delivery of the vehicle,
2. Notify Airstream or one of its authorized, independent dealers of any claimed defect within the warranty period or 10 days thereafter,
3. Provide notification of a defect within 10 days of discovery of that defect, and
4. Promptly return the motorhome to an authorized Airstream dealer or Airstream for repairs.

If you believe a defect covered by this Limited Warranty still exists after an attempted repair by an authorized Airstream dealer, you must contact Airstream in one of the following manners, and specify:

1. The complete serial number of the vehicle,
2. The date of original purchase and the date of original delivery,
3. The name of the selling dealer, and
4. The nature of the problem and the steps or service which have been performed.

Email: [support@airstream.com](mailto:support@airstream.com)

Phone: (937) 596-6111

Mail: AIRSTREAM, INC., 428 West Pike Street, P.O. Box 629, Jackson Center, Ohio 45334-0629, Attention: Owner Relations Department

Airstream may direct you to an authorized Airstream dealer, or may request that you bring your motorhome to the Airstream factory in Jackson Center, Ohio for repairs.

Airstream does not control the scheduling of repairs at its authorized Airstream dealers, and repairs at the Airstream factory may not be immediately available. Therefore, you may encounter delays in scheduling repairs and/or completion of repairs. All costs associated with transporting the motorhome for any warranty service shall be the sole responsibility of the owner.

### Consumer Arbitration Program

For recreation vehicles purchased in the State of California, Airstream, Inc. participates in the Consumer Arbitration Program for Recreation Vehicles (CAP-RV). This third-party dispute resolution program is available, at no charge to you, to settle unresolved warranty disputes for recreation vehicles. This dispute resolution program reviews eligible product and service related complaints involving warranty covered components. To find out more about this program, or to request an application/brochure, please call the Arbitration Administration office toll-free 800.279.5343. The CAP-RV program operates as a certified mechanism under the review of the California Arbitration Certification Program. Members of the armed forces who purchased the vehicle in California, or who were stationed in or a resident of California at the time of purchase (regardless of state of purchase) or who are stationed in California at the time of application to this program may utilize the CAP-RV program.

### Events That Discharge Airstream's Obligations Under This Limited Warranty

Misuse or neglect, accidents, unauthorized alteration, failure to provide reasonable and necessary maintenance (see Owner's Manual), damage caused by off road use, collision, fire, theft, vandalism, explosions, overloading in excess of rated capacities, odometer tampering, and use of the motorhome for commercial, business, or rental purposes shall discharge Airstream from any express or implied warranty obligation to repair any resulting defect.

### Legal Remedies

Exclusive jurisdiction for deciding legal disputes relating to alleged breach of express warranty and breach of implied warranties arising by operation of law as well as those relating to representations of any nature rests in the courts within the state of manufacture, which is Ohio. Also, this limited warranty shall be interpreted and construed in accordance with the laws of the state of Ohio. Any and all claims, controversies, and causes of action arising out of or relating to this limited warranty, whether sounding contract, tort or statute, shall be governed by the laws of the state of Ohio, including its statute of limitations, without giving effect to any conflict of law rule that would result in the application of the laws of a different jurisdiction.

### Airstream Limited Warranty Excludes

#### **Normal Wear**

Items such as curtains, upholstery, floor coverings, and window, door, and vent seals will show wear or may even wear out within the 3-year warranty period, depending upon the amount of usage, weather, and atmospheric conditions.

#### **Accident**

We strongly urge our dealers and customers to inspect the touring coach upon receipt of delivery for any damage caused by accident while being delivered to the dealer, or while it is on the dealer's lot. Damage of this nature becomes the dealer or customer's responsibility upon acceptance of delivery, unless Airstream is notified and the person making the delivery verifies the damage. Glass breakage, whether obviously struck or mysterious, is always accidental and covered by most insurance policies.

#### **Abuse**

Lack of customer care and/or improper maintenance will result in early failure for which Airstream cannot be held responsible.

#### **Exposure**

Deterioration by sunlight is possible to such items as tires, curtains or upholstery. Steel or metal surfaces are subject to the elements, causing rust and corrosion that is normal and beyond the control and responsibility of Airstream.

#### **Overload**

Overload Damage due to loading beyond capacity or to cause improper balance is not covered by the Airstream Limited Warranty. The Airstream Touring Coach is engineered to properly handle any normal load. There are limits to the amount of load that can be safely transported depending upon speed and road conditions. If these limits have been exceeded, the Airstream Limited Warranty will not cover resulting damage. For additional information on the load capacity of your touring coach, consult your Sprinter and Airstream Owner's Manuals or gross vehicle weight rating plate.

#### **Chemical Gassing**

Chemical gassing is not a "Defect" in your recreational vehicle and is not covered by the Limited Warranty. Please follow the recommendations in this manual to address this concern.

# General Information

## Sprinter Van

Airstream, Inc., does not accept any responsibility in connection with any of its touring coach's for the Sprinter Van or its components. The Sprinter Van and its components are covered by Mercedes-Benz Warranties as explained by Sprinter literature provided. Your Sprinter Van and its components are pre-checked by its manufacturer before delivery to Airstream. All service to the Sprinter Van and its components must be performed by Mercedes-Benz Sprinter designated service points according to the manufacturer's warranty and service policies. The literature provided with each touring coach gives important information concerning its warranty coverage, maintenance, and operation.

The Airstream Atlas Owner's Manual may provide additional information and tips on the use of the van as a touring coach, however, no information, in whole or in part, in any Airstream manual should be interpreted as advice or directions to disregard or void the Warnings, Cautions, Notices, or other information contained in the Sprinter's manuals.

### **⚠ WARNING**

**Your Mercedes-Benz Sprinter Van Operator's and Warranty Manuals contain important cautions, warnings, operational, and warranty information on the Sprinter and its components. All information in the Sprinter manual should be reviewed and followed for your safety.**

## Service

### Coach-Net® Roadside Assistance



Every new Airstream comes with a three-year, transferable subscription to Coach-Net which includes a long list of premium services to help quickly solve issues or learn about your Airstream.

To learn more, scan the QR code above, navigate to <https://www.airstream.com/owners/coach-net/>, or call Coach-Net at 855-817-1885. On-call technicians are always ready to answer questions.

## Service Centers

Before leaving the factory, every vital part of the touring coach is tested for performance. Each test is signed and certified by an inspector. After the touring coach arrives on your dealer's lot, all vital parts and systems are again tested. When you take delivery of your new touring coach, you will receive a complete check out.

At that time, a specified list of performance checks on your touring coach equipment will be conducted, and any deficiencies you have experienced since taking delivery will be corrected.

Please contact your dealer if your touring coach needs service. Major service under your Airstream Limited Warranty is available through our nationwide network of Airstream Dealer Service Centers. To find a dealer, please visit, [www.Airstream.com](http://www.Airstream.com) to use our dealer locator.

Occasionally, dealerships change, or new dealers are added that may not appear on the website immediately. Please note that all centers operate on an appointment basis for the utmost efficiency.

When you require service for your touring coach from the Airstream Factory Service Center or a Certified Dealer Service Center, please contact the service manager for an appointment, and inform them if you are unable to keep the appointment date or wish to change it. Service may be arranged at the Factory Service Center by contacting the Service Coordinator at:

Airstream Factory Service Center

428 West Pike Street

P.O. Box 629

Jackson Center, Ohio 45334-0629

Phone: (937) 596-6111 or (877) 596-6111

### **NOTE**

**Connected RV features and systems may be turned off while in a service facility for the safety of our technicians. You might have to re-pair your personal device after service appointment.**

### Reporting Safety Defects

If you believe your vehicle has a defect which could cause a crash or could cause injury or death, you should immediately inform the National Highway Traffic Safety Administration (NHTSA), in addition to notifying Airstream, Inc.

If NHTSA receives similar complaints, it may open an investigation, and if it finds that a safety defect exists in a group of vehicles, it may order a recall and remedy campaign. However, NHTSA cannot become involved in individual problems between you, your dealer, or Airstream Inc.

To contact NHTSA, you may either call the Vehicle Safety Hotline toll-free at 1-888-327-4236 (TTY: 1-800-424-9153), go to <http://www.safercar.gov>, or write to:

Administrator

NHTSA

1200 New Jersey Avenue, S.E.

Washington, DC 20590

You can also obtain other information about motor vehicle safety from <http://www.safercar.gov>.

### Camping

#### Suggested Pre-Travel Check List

##### *Exterior*

1. Verify power cord is stored.
2. Verify water and sewer hoses are stored.
3. Double check all hitch connections (if towing).
4. Look under, over, and around the vehicle for any overlooked items.
5. Ensure all exterior compartments are closed and latched.
6. Check exterior lighting.
7. Check torque of wheel bolts or lug nuts
8. Check tires for correct pressure.

##### *Interior*

1. Turn off water pump, water heater, and furnace.
2. Close windows and vents.
3. Close all interior cabinet doors.
4. Latch refrigerator door. (Seal containers first.)
5. Secure, stow, and latch for travel anything that will move, fall, or open.
6. Drain toilet bowl.
7. Turn off 12-volt lights.

##### *Touring Coach Equipment and Accessories*

1. Water hose, 5/8-in. high-pressure, tasteless, odorless, non-toxic (two 25-ft. sections).
2. Y connection - water hose.
3. Holding tank cleaner and deodorizer.
4. Power cord adapter, 30-amp capacity.
5. 30-ft. electric cord, 30-amp capacity.
6. Wheel chocks.
7. Torque wrench.
8. Quality tire gauge.
9. Verify emergency light and first aid kits.

##### *Motoring Essentials*

1. Touring coach registration.
2. Carry driver's license.
3. In Canada, bring along a non-residence liability insurance card and your passport.
4. In Mexico, you must have special auto insurance.
5. Carry an extra set of the ignition keys in a separate pocket or in your wallet.
6. Keep an operating flashlight with fresh batteries in the glove compartment.
7. Pack so that you can reach tools without completely unpacking.
8. Carry your pet's dish, food, leash, and health and registration papers.

# General Information

---

## Overnight Stop

In time you will develop a knack for spotting wonderful little roadside locations by turning off the main highway and exploring. There are many modern recreational vehicle parks, including State, County, and Federal parks with good facilities, where you may obtain electrical, water, and sewer hookups and connections. Directories are published which describe in detail these parks and tell what is available in the way of services and hookups.

All you need to do to enjoy the self-contained luxury while boondocking is to:

1. Turn on the 12-volt battery disconnect switch to provide power to your components.
2. Turn on the exterior LP gas supply, if you need to cook or start the generator.
  - Generator must be started to run the air conditioner.
  - Inverter will need to be turned on to power the entertainment devices. To conserve battery power, turn off the inverter when not in use.
3. Turn on the water pump and open faucets until air is expelled from the system.

Before moving on, turn off the LP gas and water pump. Check your campsite, both for cleanliness and to be sure you have not left anything behind. Make sure everything is properly stowed.

## Overnight or Weekend Trips

On overnight or weekend trips, chances are you will not use up the capacity of the holding tanks. Deplete the water supply, if using the system moderately or conservatively. You will need to maintain the level of your batteries during this time. The batteries will shut down at 10.5 volts. It is recommended you charge the batteries, by plugging into shore power or by starting your generator, when they reach 12 volts.

## Longer Trips

On a longer trip, when you have stayed where sewer connections and utility hookups were not available, it will be necessary for you to stop from time to time to dispose of the waste in the holding tank and replenish the water supply. Many truck stops and gas stations, chain and individually owned, have installed sanitary dumping stations for just this purpose. Booklets are available that list these facilities.

When you stop for the night, your Airstream Touring Coach is built to be safely parked in any spot that is relatively level and where the ground is firm. Your facilities are with you. You are self-contained. Try to pick as level a parking spot as possible.

## Extended Stay

Making a long trip is not very different from making a weekend excursion. Since everything you need is right at hand, you are at home wherever you go. When packing for an extended trip, take everything you need, but only what you need.

Hook up to water by attaching a ½ -inch minimum high-pressure water hose to the city water service.

Plug the 120-volt, 30-amp electrical cable into the city power service. The SmartPlug incorporates a reverse polarity feature which will include a series of light codes to let you know the condition of the power coming from the campsite power pedestal. Please refer to the provided SmartPlug owner's manual for more information on reverse polarity and the light codes; also [see Shoreline Power Inlet and Cordset on page 6-8](#).

To use the generator, you simply start it. All switching is done automatically. The generator can be started from the main Multiplex control panel just inside the entry door. It is easier on your generator, and appliances, if you'll allow the generator to reach its normal operating speed (about a minute) prior to applying heavy current loads.

Your Touring Coach is equipped with an Automatic Generator Start System (AGS). The purpose of an AGS system is to automatically start (and run) the generator when the 12 volt electrical system (house batteries) drops to a pre-determined level; [see Automatic Generator Start \(AGS\) on page 5-17](#).

Turn on the exterior LP remote power switch. Lighting a top range burner to bleed any air from the system will make it easier to start other appliances including the furnace.

When you stay for extended periods where electric or water hookups are not available, make sure to regularly check on the condition of your lithium batteries and the contents of your tanks. Both can be viewed from any of the Multiplex control panels. Carry drinking water in a clean bucket to refill your tank. When your waste tank nears capacity, move your touring coach to a dumping location.



### Leveling

When you plan to park and enjoy the features of your coach, it needs to be as level as possible.

#### NOTICE

**Level the coach before extending the slide-out room. Extending the slide-out room without first leveling could cause the slide out mechanism to bind and become damaged.**

Select an area that is as firm and level as possible. Most campgrounds provide this type of parking. For instructions on how to operate the Leveling System, see [Hydraulic Leveling System on page 6-11](#).

Airstream does not recommend placing tires in a hole for leveling. Check the tire section of the chassis portion of this manual for information on tire support; see [Tires on page 7-4](#).

### Effects of Prolonged Occupancy

Your touring coach was designed primarily for recreational use and short-term occupancy. If you expect to occupy the touring coach for an extended period, be prepared to deal with condensation and the humid conditions that may be encountered. The relatively small volume and tight compact construction of modern recreation vehicles mean that the normal living activities of even a few occupants will lead to rapid moisture saturation of the air contained in the touring coach and the appearance of visible moisture, especially in cold weather.

Just as moisture collects on the outside of a glass of cold water during humid weather, moisture can condense on the inside surfaces of the touring coach during cold weather when relative humidity of the interior air is high. This condition is increased because the insulated walls of a recreation vehicle are much thinner than house walls. Estimates indicate that two adults can vaporize up to one-and-a-half gallons of water daily through breathing, cooking, bathing, and washing. Unless the water vapor is carried outside by ventilation or condensed by a dehumidifier, it will condense on the inside of the windows and walls as moisture, or in cold weather as frost or ice. It may also condense out of sight within the walls or the ceiling where it will manifest itself as warped or stained panels. Appearance of these conditions may indicate a serious condensation problem. When you recognize the signs of excessive moisture and condensation in the touring coach, action should be taken to minimize their effects.

#### NOTICE

**Your touring coach is not designed, nor intended, for permanent housing. Use of this product for long term or permanent occupancy may lead to premature deterioration of structure, interior finishes, fabrics, carpeting, and drapes. Damage or deterioration due to long-term occupancy may not be considered normal, and may under the terms of the warranty constitute misuse, abuse, or neglect, and may therefore reduce the warranty protection.**

To avoid condensation problems, try to follow these tips to help alleviate excess moisture:

- Allow excess moisture to escape to the outside when bathing, washing dishes, hair drying, laundering, and using appliances and non-vented gas burners. Always use an exhaust fan when cooking.
- Keep the bathroom door closed and the vent or window open when bathing and for a period of time after you have finished.
- If you are experiencing condensation, you may want to reconsider hanging wet clothes in the touring coach to dry.
- In hot weather, start the AC early as it removes excess humidity from the air while lowering the temperature.
- Keep the temperature as reasonably cool during cold weather as possible. The warmer the vehicle, the more cold exterior temperatures and warm interior temperatures will collide on wall surfaces, thus creating condensation.
- Use the ceiling vent to keep air circulating inside the vehicle so condensation and mildew cannot form in dead air spaces. Allow air to circulate inside closets and cabinets (leave doors partially open). Please keep in mind that a closed cabinet full of stored goods prevents circulation and allows the exterior temperature to cause condensation.
- The natural tendency would be to close the vehicle tightly during cold weather. This will actually compound the problem. Simply put, you need to remove some of the warm air and allow some cool outside air to get inside the vehicle so the furnace will not recycle the humid interior air.
- Minimize the use of incandescent lights, which produce heat and contribute to condensation.

# General Information

## About Molds

### What are molds

Molds are microscopic organisms that naturally occur in virtually every environment, indoors and out. Outdoors, mold growth is important in the decomposition of plants. Indoors, mold growth is unfavorable. Left unchecked, molds break down natural materials, such as wood products and fabrics. Knowing the potential risks is important for any type of homeowner to protect their investment.

### What factors contribute to mold growth

For mold growth to occur, temperatures, indoor or outdoors, must be between 40°F and 100°F and, there must be a source of moisture, such as humidity, standing water, damp materials, etc. Indoors, the most rapid growth occurs with warm and humid conditions.

### How can mold growth be inhibited

By controlling relative humidity, the growth of mold and mildew can be inhibited. In warm climates, use of the air conditioner will reduce the relative humidity. Vents are located in the bathing and cooking areas and constant use is advised during food preparation and bathing, even during colder weather. Additionally, opening a window during these activities will assist in ventilation. In extremely humid conditions, the use of a dehumidifier can be helpful. If using a dehumidifier, please read and follow all manufacturer instructions and recommendations to the use and cleaning of the dehumidifier.

Frequent use of your touring coach or cleaning regularly is an important preventive measure. Further, any spills should be wiped up quickly and dried as soon as possible. Avoid leaving damp items lying about. On safe surfaces, use mold or mildew killing cleaning products. Check sealants regularly, and reseal when necessary to avoid water leaks. Proper preventive maintenance to the touring coach and its accessories, as described both in this manual and in accompanying literature, will provide the best protection to the touring coach.

## Waste Water System

The main parts of the waste water system are the toilet, holding tanks, and tank dump valves; [see Drain and Waste System on page 9-10](#). The system is designed to provide complete self-contained toilet facilities, while on the road or parked, without being connected to a sewage line. It may also be used when parked while connected to a sewage hose.

Keep the dump valves closed with either method and empty the tanks when they are nearly full. The idea is to send a large volume of water through the tanks and hose at the same time to float solids away.

After the sewage tank has been emptied, close the dump valves and charge the tank by putting a few gallons of water in the sewage holding tank using the black tank flush inlet. This will spray the interior of the tank with water and help prevent solids from building up in the sewage holding tank. The addition of a deodorizing agent like Aqua-Kem will help prevent odors.

Should you ever have a buildup of solids, close the valves, fill the tanks about 3/4 full with fresh water, drive a distance to agitate the solids, and drain the tanks.

### Things Not to Put into Toilet or Drains

- Facial tissues and feminine hygiene products (they do not dissolve like toilet paper).
- Automotive antifreeze, ammonia, alcohols, or acetone.
- Table scraps or other solids that may clog the drains.

### Drain System

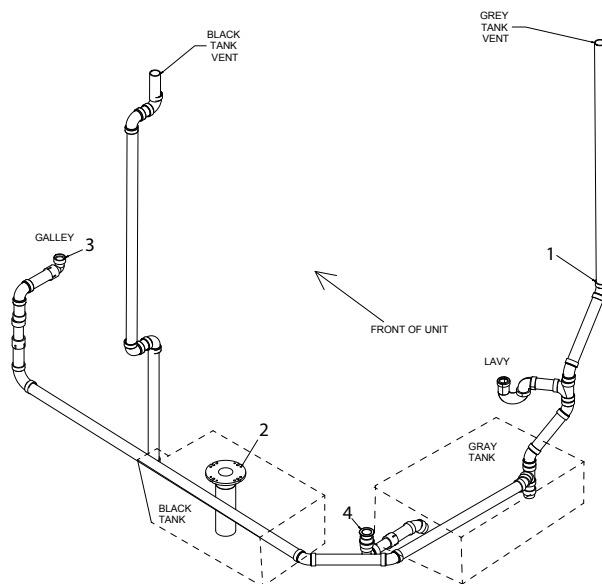

1. Lavatory Drain
2. Black Water Tank (Toilet)
3. Galley Drain
4. Shower Drain

## Winter Traveling

Traveling in sub-freezing temperatures will require certain precautions to protect the plumbing system and your personal belongings from being damaged by freezing.

While traveling, simply use your common sense. How cold is it? How long will it be before you can turn the heat back on? Is the temperature dropping or rising? Remember, when driving at 50 MPH, the wind chill factor will cause the interior of the touring coach to cool much faster than a touring coach that is parked.

1. You must have a plentiful supply of fuel as the heat from the furnace warms the touring coach and keeps the fresh water lines from freezing.
2. If your stay is longer than overnight, you should endeavor to have 120-volt electricity available. Of course, you can run your generator to recharge the batteries, or even use the generator continually. Keep an eye on your generators fuel. Since the generator starts off the house batteries, it is recommended to start the generator prior to running the batteries down.
3. Minimize use of electricity if 120-volt power source is not available.
4. Leave cabinet doors, wet bath doors, and wardrobe doors slightly open at night to allow circulation of air in and around all components.
5. Save 12-volt power by using non-toxic RV-approved antifreeze in the water holding tanks instead of the heating pads to prevent freezing. Quantity of antifreeze needed will vary with ambient temperature and the amount of liquids in tanks.
6. For extended stays in cold weather, insulate all water lines outside the touring coach. You should remember that low temperatures in combination with high winds cause an equivalent chill temperature much below what your thermometer is reading. For instance, with an outside temperature of zero degrees, and the wind velocity of 10 miles per hour, the equivalent chill temperature is -20°F.
7. Remember to remove and drain the exterior shower faucet to prevent freeze damage.

## Heated Tanks



The Atlas Touring Coach has 12-volt heat pads installed with the fresh water, grey water, and black water holding tanks to help prevent freezing. The tank pads are controlled by any of the Multiplex control panels throughout your touring coach. When the outside temperature is near freezing, simply switch “ON” the holding tank heaters. Built-in sensors will activate the heat pads when the contents of the tank drops to 44°F. Once the liquid is heated and rises to 64°F the heat pads will automatically deactivate. Switch the power “OFF” when the ambient outside temperature remains above freezing or the tanks are empty. The tank heaters will quickly deplete the house batteries unless the unit is plugged into an external AC power source or the generator is ran to operate the inverter/charger. To conserve battery power, RV antifreeze may be used to protect the gray and black tanks.

### NOTICE

**Drain and winterize if the water systems are not being used during winter traveling; see [Winterizing and Storage on page 9-12](#).**



# AIRSTREAM®

## Section 4 FLOOR PLANS AND SPECIFICATIONS

|  |      |
|--|------|
| FLOOR PLANS . . . . .                                | .4-2 |
| Tommy Bahama Atlas . . . . .                         | .4-2 |
| SPECIFICATIONS . . . . .                             | .4-3 |
| Tommy Bahama Atlas Specifications . . . . .          | .4-3 |
| Specifications Definitions . . . . .                 | .4-4 |
| Specifications Labels . . . . .                      | .4-4 |
| Occupant and Cargo Carrying Capacity Label . . . . . | .4-4 |
| Tire and Loading Placard . . . . .                   | .4-4 |
| Manufacturer's Certification Label . . . . .         | .4-4 |

# Floor Plans And Specifications

---

## Floor Plans

### Tommy Bahama Atlas

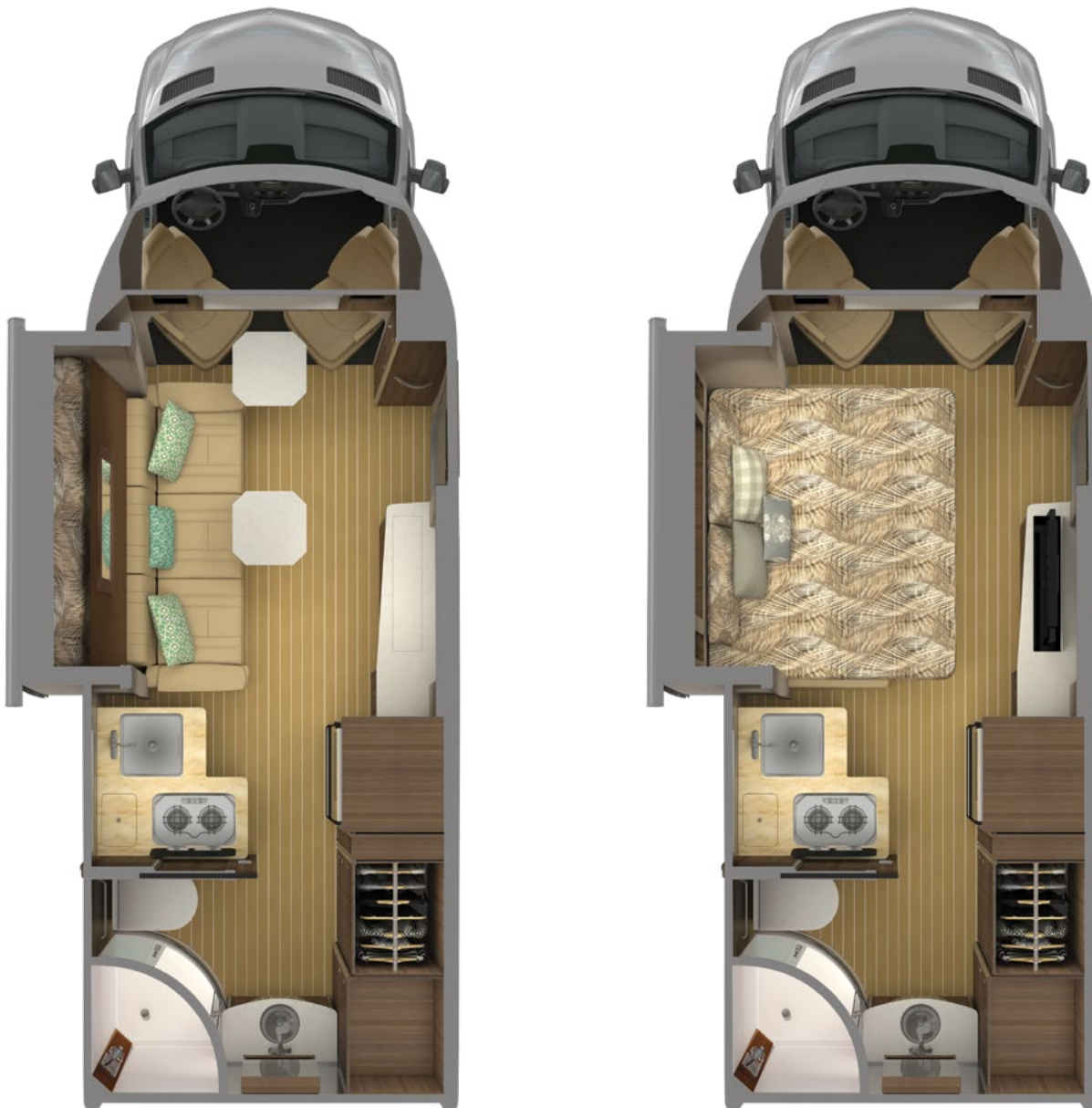

## Specifications

| <b>Tommy Bahama Atlas Specifications</b>                  |   |
|---|---|
| Chassis   | Mercedes-Benz® Sprinter 4500  |
| Engine  | Mercedes-Benz® 2.0L Turbo Charged High Output 4-Cylinder Diesel   |
| Horsepower/Torque   | 208HP/332 lb-ft Torque  |
| Transmission  | 9G-Tronic, 9 Speed Automatic Transmission   |
| Emissions   | BlueTEC SCR Technology, 50 State – EPA/CARB Standards   |
| Axle Ratio  | 4.727   |
| Wheelbase   | 170"  |
| MPG <sup>[1]</sup>  | 16-18 Estimated Highway   |
| Exterior Overall Length                                   | 24' 9"  |
| Exterior Overall Height with A/C and Antenna              | 10' 6"  |
| Exterior Overall Width                                    | 9' 1.5"   |
| Interior Height   | 6' 6"   |
| Interior Width  | 7' 4.5"   |
| GVWR <sup>[2]</sup>                                       | 12,125 lbs  |
| GCWR <sup>[2]</sup>                                       | 15,250 lbs  |
| UVW/UBW <sup>[2]</sup>                                    | Weights are listed on the OCCC Label and Tire and Loading Placard; for more information, <a href="#">see Specifications Labels on page 4-4</a>  |
| OCCC <sup>[2]</sup>                                       |   |
| Tow Capacity/Tongue Weight <sup>[3]</sup>                 | Up To 4,000 lbs/400 lb tongue weight  |
| Fuel Tank   | 24.5 gallon   |
| Fresh Water Tank  | 23 gallon   |
| Gray Water Tank   | 31 gallon   |
| Black Water Tank  | 27 gallon   |
| LPG   | 9.8 gallon  |
| Water Heater  | 60,000 BTU Continuous Flow, LPG   |
| Air conditioner   | 15,000 BTU  |
| Furnace   | 19,000 BTU  |
| Refrigerator w/Freezer (12V - 120V)                       | 9.1 cubic feet  |
| Microwave   | 1.1 cubic feet  |
| Cooktop   | 2 Burner with Integrated Cover  |
| Generator   | Cummins Onan, 30A, 3.6 kW, LPG  |
| Batteries (House)   | (2) 100Ah lithium batteries with built-in heaters   |
| Inverter/Charger  | 1,000 Watt Inverter, 50-Amp Charger   |
| Shore Power   | 30-Amp/120-Volt Service   |
| Solar Power   | 400 Watt Solar System (300W - House/100W - Chassis)   |
| Bed Size (Rear Lounge)                                    | 73" X 73"   |
| Wheel Fastener Torque Value <sup>[4]</sup>                | 133 ft-lbs  |
| Tire Size / Max Cold Inflation Pressure <sup>[2][5]</sup> | Tire size and max cold inflation pressure are listed on the Tire and Loading Placard on the B-pillar (driver's door jamb); For more information, <a href="#">see Tire and Loading Placard on page 4-4</a> |
| Airstream Warranty  | 3 Years/36,000 Miles  |
| Mercedes-Benz® Warranty                                   | 5 Years/75,000 Miles  |
| Mercedes-Benz® Engine Warranty                            | 5 Years/100,000 Miles   |

1. Actual mileage will vary based on load carrying, driving style, and road conditions.
2. For more information, [see Specifications Definitions on page 4-4](#) and [see Specifications Labels on page 4-4](#).
3. Tow capacity will vary with build spec and intended vehicle loading with people, cargo, and fluids.
4. For safety reasons, wheel fastener torque must be checked immediately after reinstalling wheels and again after 30 miles.
5. In this context, cold refers to how long a tire has sat idle. *Max cold inflation pressure* should be checked in the morning (after sitting idle for at least three hours) before driving more than one mile or before rising ambient temperatures and the sun's radiant heat can affect tire pressure.

# Floor Plans And Specifications

## Specifications Definitions

**Unloaded Vehicle Weight (UVW)** or Unit Base Weight (UBW) is the factory manufactured/empty weight of the touring coach. UVW includes fuel, engine and generator operating fluids, LP gas, and all batteries; *UVW is listed as “factory manufactured weight” on the Tire and Loading Placard.*

**Gross Combined Vehicle Weight Rating (GCWR)** is the maximum weight rating of the vehicle with a trailer attached; *GCWR is listed on the previous page.*

**Gross Axle Weight Rating (GAWR)** is the value specified as the load carrying capacity of a single axle system, as measured at the tire-ground interfaces. This is the maximum amount of weight that can be placed on each axle; *GAWR is listed on the Manufacturer’s Certification Label.*

**Gross Vehicular Weight Rating (GVWR)** is the maximum permissible weight of the Touring Coach when fully loaded; *GVWR is listed on the Tire and Loading Placard and Manufacturer’s Certification Label. It is also listed on the previous page.*

**Occupant and Cargo Carrying Capacity (OCCC)** is the maximum total weight of all occupants, cargo, fresh water, and any tongue weight of a towed trailer; *OCCC is listed on the OCCC label and Tire and Loading Placard.*

**GVWR - UVW = OCCC**

**⚠ WARNING**

The combined weight of occupants and cargo should never exceed the limit on OCCC label.

**⚠ WARNING**

Wheel fastener torque must be checked immediately after reinstalling a wheel and again after 30 miles. Torque all wheel fasteners evenly to specification using the proper sequence; see [Wheel Bolt/Lug Nut Tightening on page 7-8](#). For torque values, see [Specifications on page 4-3](#).

**NOTE**

All product information and specifications listed are as accurate as possible at the time of printing. Since we continually strive to improve our products, all specifications are subject to change without notice.

**NOTE**

Specifications labels shown are examples only.

## Specifications Labels

### Occupant and Cargo Carrying Capacity Label

**MOTOR HOME OCCUPANT CARGO CARRYING CAPACITY**  
**VIN: XXXXXXXXXXXXXXX**  
**THE COMBINED WEIGHT OF OCCUPANTS AND CARGO SHOULD NEVER EXCEED**  
**XXX kg OR XXX LBS**  
 Safety belts equipped seating capacity: X  
**CAUTION:**  
 A full load of water equals XX kg or XXX lbs of cargo @ 1kg/L (8.3lb/gal) and the tongue weight of a towed trailer counts as cargo.  
 Motor Home overall length XXX (XXX cm) as manufactured

The Occupant and Cargo Carrying Capacity Label on the edge of the passenger door lists the VIN, OCCC, safety belt equipped seating capacity, the weight of a full load of water, and the motorhome’s overall length.

### Tire and Loading Placard

**TIRE AND LOADING INFORMATION**  
**RENSEIGNEMENTS SUR LES PNEUS ET LE CHARGEMENT**

The combined weight of occupants and cargo should never exceed XXX kg or XXXX lbs.

SEATING CAPACITY TOTAL X FRONT X REAR X

| TIRE PNEU        | SIZE DIMENSIONS | COLD TIRE PRESSURE PRESSION DES PNEUS A FROID | SEE OWNERS MANUAL FOR ADDITIONAL INFORMATION<br>VOIR LE MANUEL DE L'USAGER POUR PLUS DE RENSEIGNEMENTS |
|------------------|-----------------|---|--|
| FRONT AVANT      | XXXXXXXXXX      | XXX kpa (XX Psi)                              |  |
| REAR ARRIERE     | XXXXXXXXXX      | XXX kpa (XX Psi)                              |  |
| SPARE DE SECOURS | XXXXXXXXXX      | XXX kpa (XX Psi)                              |  |

The factory manufactured weight of this motor home is XXXX kgs XXXX (lbs).  
 The GVWR of this motor home is XXXX kgs XXXX (lbs).

The Tire and Loading Placard on the B-pillar (driver’s door jamb) lists OCCC, UVW, GVWR, seating capacity, tire size, tire cold inflation pressure, and the last six digits of the serial number.

### Manufacturer’s Certification Label

**MANUFACTURED BY : AIRSTREAM, INC**

|                 |              |             |                         |  |
|-----------------|--------------|-------------|-------------------------|--|
| GVWR:           | XXXX kg/     | XXXX lb     | DATE: XXXXXXXX          | XXX                                    |
| <b>GAWR</b>     | <b>TIRES</b> | <b>RIMS</b> | <b>COLD INFL.PRESS.</b> |  |
| <b>FRONT</b>    | XXXXXXXXXX   | XXXX        | XXX KPA                 | <b>SINGLE</b> <input type="checkbox"/> |
| XXXX KG/ XXX LB |              |             | XX PSI                  | <b>DUAL</b> <input type="checkbox"/>   |
| <b>INTERM</b>   |              |             | PSI                     | <b>SINGLE</b> <input type="checkbox"/> |
|                 |              |             |                         | <b>DUAL</b> <input type="checkbox"/>   |
| <b>REAR</b>     | XXXXXXXXXX   | XXXX        | XXX KPA                 | <b>SINGLE</b> <input type="checkbox"/> |
| XXXX KG/ XXX LB |              |             | XX PSI                  | <b>DUAL</b> <input type="checkbox"/>   |

THIS VEHICLE CONFORMS TO ALL APPLICABLE U.S. FEDERAL MOTOR VEHICLE SAFETY STANDARDS IN EFFECT ON THE DATE OF MANUFACTURE SHOWN ABOVE ALL WEIGHTS ARE APPROXIMATE

V.I.N./N.I.V.:XXXXXXXXXXXXXXXXXX TYPE/TYPE: XXXXXXXX MODEL: XXXXXX  
 XXXXXXXXXXXXXXXXXXXX XX XXX Serial: XXXXXXXXXXXXXXXXXXXX

The Manufacturer’s Certification Label on the driver’s seat pedestal lists the GVWR, GAWR, date of manufacture, tire size, rim size, tire cold inflation pressure, VIN/NIV number, vehicle type, model, and the full serial number.



# AIRSTREAM®

## Section 5 INTERIOR

|   |     |   |      |
|---|-----|---|------|
| GENERAL INFORMATION AND CLEANING . . . . .            | 5-3 | Power Shades . . . . .                            | 5-8  |
| Upholstery . . . . .                                  | 5-3 | Remote Instructions . . . . .                     | 5-8  |
| PermaBlok3® by Spradling . . . . .                    | 5-3 | ELECTRICAL SYSTEM OVERVIEW . . . . .              | 5-9  |
| Cabinets and Overhead Lockers . . . . .               | 5-3 | Power Center . . . . .                            | 5-9  |
| Aluminum Interior Skin . . . . .                      | 5-3 | Circuit Breaker Protection . . . . .              | 5-9  |
| Counter Area . . . . .                                | 5-3 | Ground Fault Circuit Interrupter (GFCI) . . . . . | 5-10 |
| Sinks . . . . .                                       | 5-3 | GFCI Breaker Test . . . . .                       | 5-10 |
| Luxury Woven Vinyl Floor . . . . .                    | 5-4 | Power Center Fuses . . . . .                      | 5-10 |
| General Cleaning . . . . .                            | 5-4 | Auxiliary Fuse Locations . . . . .                | 5-10 |
| Interior Doormat and Rug Selection . . . . .          | 5-4 | 120 Volt System . . . . .                         | 5-11 |
| Privacy Sun Shades . . . . .                          | 5-4 | City Power Overview . . . . .                     | 5-11 |
| Shower Stall . . . . .                                | 5-4 | Outlets and USB ports . . . . .                   | 5-11 |
| Shower Head . . . . .                                 | 5-4 | Energy Management System (EMS) . . . . .          | 5-11 |
| Toilet . . . . .                                      | 5-4 | Operation . . . . .                               | 5-11 |
| Deodorizers and Biological Chemicals . . . . .        | 5-5 | Display Panel . . . . .                           | 5-11 |
| Faucets . . . . .                                     | 5-5 | 12 Volt System . . . . .                          | 5-12 |
| Faucet Cleaning and Care . . . . .                    | 5-5 | Solar System . . . . .                            | 5-12 |
| Murphy Bed . . . . .                                  | 5-6 | ELECTRICAL SYSTEM OPERATION . . . . .             | 5-13 |
| Preparing the Sofa . . . . .                          | 5-6 | Battery Disconnect Switch . . . . .               | 5-13 |
| Lowering the Bed . . . . .                            | 5-6 | House Batteries . . . . .                         | 5-14 |
| Slide-Out Room . . . . .                              | 5-7 | Battery Management System (BMS) . . . . .         | 5-14 |
| Before Operating the slide out Room . . . . .         | 5-7 | High Voltage Disconnect . . . . .                 | 5-14 |
| Extending and Retracting the Slide-out Room . . . . . | 5-7 | Low-Voltage Disconnect . . . . .                  | 5-14 |
| Entertainment Cabinet . . . . .                       | 5-7 | Battery Charge . . . . .                          | 5-15 |
| Storage Tips . . . . .                                | 5-7 | Temperature Limits . . . . .                      | 5-15 |
| Cabinets, Roof Lockers, and Cubbies . . . . .         | 5-7 | Cold Weather Usage . . . . .                      | 5-15 |
| Pedestal Tables . . . . .                             | 5-8 | Inverter/Charger . . . . .                        | 5-16 |
| Bar Cabinet . . . . .                                 | 5-8 | Generator . . . . .                               | 5-16 |
| Driver and Passenger Seats . . . . .                  | 5-8 | Automatic Generator Start (AGS) . . . . .         | 5-17 |

## Section 5 Interior

|   |       |                                      |       |
|---|-------|--------------------------------------|-------|
| 120-Volt Automatic Switch Over Box . . . . .      | .5-18 | APPLIANCES . . . . .                 | .5-24 |
| Generator/City Power . . . . .                    | .5-18 | Maintenance . . . . .                | .5-24 |
| Battery Charging . . . . .                        | .5-18 | Air Conditioner . . . . .            | .5-24 |
| Charging via Shoreline Connection . . . . .       | .5-18 | Heat Pump . . . . .                  | .5-24 |
| Charging via Generator . . . . .                  | .5-19 | Cooktop . . . . .                    | .5-25 |
| Charging via Alternator . . . . .                 | .5-19 | Ceiling Vent Fan . . . . .           | .5-25 |
| Charging via Solar Power . . . . .                | .5-19 | Operation . . . . .                  | .5-25 |
| Charging the Chassis Battery . . . . .            | .5-19 | Thermostat and Rain Sensor . . . . . | .5-25 |
| Multiplex System . . . . .                        | .5-20 | Cleaning Instructions . . . . .      | .5-25 |
| Systems Controlled By Firefly . . . . .           | .5-20 | Furnace . . . . .                    | .5-26 |
| Multiplex Home Screen/Monitor Panel . . . . .     | .5-20 | Microwave Ovens . . . . .            | .5-26 |
| Multiplex Secondary Screens . . . . .             | .5-20 | Refrigerator . . . . .               | .5-26 |
| Cleaning the Multiplex Touchscreens . . . . .     | .5-20 | Operation . . . . .                  | .5-26 |
| Lighting . . . . .                                | .5-21 | Start up . . . . .                   | .5-26 |
| Multiplex Bluetooth® App . . . . .                | .5-21 | Defrost and Cleaning . . . . .       | .5-26 |
| ENTERTAINMENT SYSTEMS . . . . .                   | .5-22 | Skylight . . . . .                   | .5-26 |
| Digital Media Player . . . . .                    | .5-22 | Water Heater . . . . .               | .5-27 |
| Subwoofer . . . . .                               | .5-22 | Control Center . . . . .             | .5-27 |
| Video . . . . .                                   | .5-22 |                                      |       |
| TV Operation . . . . .                            | .5-22 |                                      |       |
| TV/Radio Antenna . . . . .                        | .5-22 |                                      |       |
| Antenna Pre-Wiring . . . . .                      | .5-22 |                                      |       |
| Roof Mounted Satellite . . . . .                  | .5-22 |                                      |       |
| Portable Satellite Antenna . . . . .              | .5-22 |                                      |       |
| External Hookup . . . . .                         | .5-22 |                                      |       |
| Starlink Internet/Wi-Fi . . . . .                 | .5-23 |                                      |       |
| Starlink Antenna Heater . . . . .                 | .5-23 |                                      |       |
| Airstream Connected RV Antenna Pre-Wire . . . . . | .5-23 |                                      |       |

## General Information and Cleaning

The interior of each Airstream Atlas has been designed for comfort, convenience, durability, and appearance. How you use it and how you take care of it, naturally, depends on you. However, if you learn to operate the interior components and take care of them and the touring coach properly, this knowledge will add to your pleasure, as well as the long life of your touring coach. All material should be professionally dry cleaned to remove any overall soiled condition.

### Upholstery

The best way to keep your Ultraleather seating looking great is regular cleaning to prevent excess dirt from accumulating. To help extend the life of the fabric, wipe up spills as soon as they occur. Clean with soap and water. Sanitize using disinfectants such as (1:5) bleach/water solution. For stubborn stains, wipe off with isopropyl alcohol as soon as possible. Thoroughly rinse all solution residue with clean water and air dry.

#### NOTICE

**Never remove cushion covers for separate dry cleaning or washing. Any tumble cleaning method can destroy the backing, and/or shrink or otherwise damage upholstery fabric.**

### PermaBlok3® by Spradling

PermaBlok3® is a vinyl protective coating that's engineered to create a tough, effective barrier against the three biggest problems: germs, abrasion, and stains. You can not see it or feel it, yet the protection it offers results in extended performance and lasting beauty with minimum care. Most stains can be removed with a damp cloth and cleaned with a 1:1 mix of Ivory® soap and water. A 1:1 mix of ammonia and water, or a 1:4 mix of bleach and water can be used for more stubborn stains. Only if needed a 1:1 mix of isopropyl alcohol and water can be used. Use only a soft cotton cloth and rub the stain in a circular motion. Rinse thoroughly with clean water and pat dry.

### Cabinets and Overhead Lockers

The furniture is manufactured from a high-pressure laminate and can be cleaned with soap and water, or you can use a common solvent on tough spots. Furniture polish can be used sparingly. Plexiglass doors must be cleaned with an antistatic cleaner and cloth. Windex or common ammonia products will damage the coating on the surface.

#### NOTICE

**Do not use any abrasive material, abrasive cleaners, cloths and pads as there is the possibility they could scratch the surface.**

### Aluminum Interior Skin

The metal interior skin on the ceiling is coated with a baked-on acrylic coating. Use soft rags or wash mitts always moving lengthwise with the grain of the aluminum. NEVER rub hard on the coating. Oil, grease, dust, and dirt may be removed by washing with a 5 percent solution of commonly used commercial and industrial multi-purpose detergent in water. Cleaning should be followed by a thorough clean water rinse. Drying the metal with a chamois or a soft cloth may prevent spots and streaks. When washing or waxing the metal, always wipe "with" the grain of the metal. A good grade of nonabrasive automotive paste or liquid wax once a year will increase the life of the finish.

#### NOTICE

**Abrasive polishes or cleaning solvents such as automatic dishwasher or acid etch cleaners are too strong and should never be used. Rinse all grit from surface prior to washing. Use soft rags always moving lengthwise with the unit. NEVER rub with excessive pressure on the coating. Even the softest rag will damage the coating if excessive pressure is applied.**

### Counter Area

The solid surface counter tops only require everyday cleaning with a damp cloth or sponge. Dry with a soft cloth or paper towel to prevent spotting. Basic stains can be cleaned with an ammonia-based product such as household glass cleaner or non-abrasive spray-on cleaners for solid surface products. More stubborn stains can be removed by spraying a non-abrasive product such as Formula 409® over the stain and wait for a couple minutes. Scrub in small circular motions with a wet sponge followed by a rinse with clean water and drying with a soft cloth or paper towel. Avoid exposing the counter tops to strong chemicals such as paint removers, acetone, and oven cleaners. Promptly rinse, with water, spots that may have come in contact with these types of cleaners. A protective pad should always be used under hot utensils or pans.

### Sinks

Cleaning can be accomplished using a mild liquid detergent on a soft cloth.

## Luxury Woven Vinyl Floor

### General Cleaning

One of the best ways to keep the floor looking good is to wipe fabrics off on a weekly basis with clean water. This helps prevent dirt from becoming deeply embedded in the fabric and eliminates the need for more vigorous cleaning. For general or light cleaning, brush off loose dirt and wipe down the floor. Prepare a solution of water and mild soap such as dish washing liquid or household cleaner. Using a soft bristle brush to clean, apply a small amount of water and soap mixture to the stain. Rinse thoroughly until all soap residue is removed. Allow the floor to air dry. For more stubborn stains and mildew, prepare a solution of 1 cup bleach and 1/4 cup mild soap per gallon of water. Apply a small amount of bleach and soap mixture to the stain and blot with a sponge or clean towel. Rinse thoroughly to remove all soap residue. Allow to air dry. A citrus based cleaner like D-Limonene can be used for tough dirt and grease spots. Ammonium based products are NOT recommended. All cleaning products need to be rinsed off thoroughly and air dried after cleaning.

### NOTICE

**Protect the area around your flooring if using a bleach solution. The use of certain cleaning agents, including but not limited to powdered abrasives, solvents, and industrial strength cleaners is not recommended. Always follow the manufacturer's instructions. Check that the cleaner/polish is suitable for use with cushioned vinyl floor coverings.**

### Interior Doormat and Rug Selection

To avoid staining or discoloration of vinyl flooring, only use doormats or rugs made of natural fibers.

### NOTICE

**Rubber or latex-backed mats or furniture with rubber feet may stain or discolor vinyl flooring.**

### Privacy Sun Shades

Privacy shades are provided for the front windshield and driver/passenger cab windows. The shades have magnets sewn into them that attach to the van.

Light brushing with an upholstery brush or gentle use of a vacuum cleaner will suffice in most situations. For heavy soiled conditions dry clean only. Washing the shades may void the warranty.

## Shower Stall

To clean your fiberglass shower stall unit, use warm water and a liquid detergent. Do not use abrasive cleaners as they may scratch and dull the surface. Stubborn stains can be removed with solvents such as turpentine, paint thinner, or acetone. Restore dulled areas by rubbing with an automotive-type liquid cleaner, and then put the soft glow back into the sides of your unit with a light application of liquid wax. The teak used in the shower is the highest grade available and has been oiled with Interlux™ Premium Teak Oil. To clean use Maritime™ Teak Cleaner, a non-acidic/non-caustic powder cleaner, and rinse with clean water. Use only a soft bristled brush or sponge, always across the grain, for scrubbing. A single coating of teak oil may be re-applied from time to time.

### Shower Head

The shower head is designed to give maximum flexibility in usage, and provides for water-saving techniques when using your touring coach on self-containment. Normally, the best water conservation procedure is to wet the entire body, turn the water off, apply soap, lather thoroughly, and then rinse the soap off.

### Toilet

Please see the toilet owner's/user manual for warranty, user tips, and maintenance information.

Always add water before flushing solids and toilet paper, and leave at least an inch of water in the bowl so that holding tank odors do not enter the living space.

To add water to the toilet, depress the flush pedal part way.

To flush, depress the pedal until it contacts the floor. When flushing liquids, depress the pedal for approximately 1–2 seconds. When flushing solids, depress the pedal until the bowl rinses. Flushing longer than necessary will cause the holding tank to fill too quickly.

**NOTICE**

Flush only water, bodily wastes, and rapid-dissolving toilet tissue down the toilet. Failure to follow these instructions could cause clogging or damage.

**NOTICE**

When you dump the bowl of the toilet, make sure all paper and solids have cleared the slide mechanism before you allow it to close. Failure to do so can cause the groove for the slide to become jammed and the slide will no longer close completely.

**Deodorizers and Biological Chemicals**

There are many deodorizers and processing chemicals on the market in tablet, liquid, and powder form. These not only combat odor, but also stimulate the bacteria that works to dissolve the solids and tissues in your waste tank. These chemicals should be introduced through the toilet prior to use per the manufacturers directions. It's also important to always add a few gallons of water by filling the toilet bowl a few times and depressing the foot pedal.

**Faucets**

**Faucet Cleaning and Care**

All that is needed to clean your faucet is a soft, damp cloth. Airstream does not recommend the use of scour pads, cleansers, or chemicals. The abrasive nature of these substances could damage the faucet's finish. A non-abrasive car wax will help to protect the finish.

**Lavatory Faucet**



Airstream Part #602871-01  
Pfister - Model: LG42-WR0Y

**Galley Faucet**



Airstream Part #602634  
Kohler - Model: K-560-2BZ

**Shower Head**



Airstream Part #602978  
Delta - Model: D59424RB18PK

**Shower Handle**



Airstream Part #602640  
Kohler - Model: KTS-45110-4-2BZ

## Power Sofa



The sofa has power adjustment controls, located on the outside of each armrest, used to recline each end of the sofa. Also located on each armrest is a set of USB ports for plugging in your electronic devices.

## Murphy Bed

### Preparing the Sofa



The power sofa is also used as the base support for the murphy bed. Clear the surrounding area of any obstructions before you begin. Remove the dinette table and store in the drawer at the base of the sofa. Make sure the sofa is in its normal upright position and not reclined. Press and hold the right arrow switch located on the side of the sofa. Lower the sofa fully until it stops and release the switch. To return the sofa to its upright position press and hold the left arrow switch.

### **⚠ CAUTION**

**Make sure to read, understand, and follow all information, Notes, Cautions, and Warnings in the manual before operating the Murphy bed.**

## Lowering the Bed

1. It is recommended that if you are using the Murphy bed with the slide-out wall extended to level the vehicle first. However, the Murphy bed has been designed for use without the wall extended. In this case, leveling would not be necessary.
2. Remove the sofa armrests. The armrests are held on by Velcro and can be stored in the sofa's drawer.
3. Disengage murphy bed lock.



4. With Murphy Bed Lock Disengaged, rotate the pull handle in the upper corners of the wall and pull down to lower the bed. While lowering watch for any interference points. If there is any contact raise the bed and fix the interference before lowering again.
5. As the bed is lowered the headboard will flip down to fill the space between the bed and wall. If the headboard fails to lower simply flip it down by hand once the bed is lowered. In some cases, if the headboard wasn't flipped up before the bed was raised, the headboard may become lodged under the bed. If this should happen raise the foot of the bed slightly and flip the headboard up by hand.

To raise the bed follow the lowering steps in reverse order. Be sure to flip up the headboard before raising the bed. This will help prevent it from becoming lodged the next time the bed is lowered.

### Slide-Out Room

The Airstream Atlas is equipped with an expandable slide-out room which provides extra living space. The slide-out rooms motor features a stop limit that will automatically stop the motor when the room is fully extended/retracted.

**⚠ CAUTION**

**Before operating, review all instructions in the Lippert In-Wall Slide-Out Owner's Manual provided in your owner's packet.**

#### Before Operating the slide out Room

1. Ensure the touring coach is properly leveled and supported using the stabilizing jacks.

**NOTICE**

**If the touring coach is not properly leveled before extending the slide-out room, the slide-out mechanism may become damaged.**

2. Make sure there is adequate space beside the touring coach for the slide-out room to be fully extended.
3. Check the interior of the touring coach to ensure there are no obstructions on the floor or leaning against the wall.
4. Check the exterior of the unit to ensure all exterior compartment doors are closed and all obstructions are removed.
5. Make sure all people stand clear before operation.

**⚠ WARNING**

**Never drive the touring coach with the slide out room extended.**

#### Extending and Retracting the Slide-out Room

The control switch is located inside the full height cabinet to the right of the entry door and is labeled for your convenience. The auxiliary section of the Multiplex control panels "Awning and Lifts" screen can also be used. Once pressed the screen will display "OPN" or "CLS" next to the Slide Out option.

1. Depress and hold the switch down (Extend) until the room is fully extended. Only when the room is fully extended is it completely weather tight. Leaving the room partially extended can allow moisture and dirt to enter the touring coach.

2. Depress and hold the switch up (Retract) to retract the room. Make sure the room has fully retracted ensuring a complete seal from the outside.

**NOTICE**

**Check for worn and cracked weather seals around the slide-out room. Extensive travel and use can cause the seals to deteriorate and may allow moisture and dirt to enter.**

**NOTICE**

**Inspect Slide-Out for any visible signs of damage before and after movement of the room.**

**NOTE**

**When using the Multiplex panel Open/Close will replace Extend/Retract.**

### Entertainment Cabinet

The entertainment cabinet houses a hidden power lifted LED HDTV and sound bar. When the TV is not in use the cabinet can be used as additional counter space. When you want to watch TV press the TV lift switch located on the side of the entertainment cabinet at the entry door or on the Multiplex control panels. Pressing the TV lift UP button will activate the TV lift bringing the TV up through the cabinet top. When your ready to lower the TV press the DOWN switch and the TV lift will lower into the cabinet closing the counter top lid automatically.

**NOTICE**

**Before activating the TV lift be sure the counter top is clear of any objects. The lift is designed to shut off automatically if the lid is obstructed and cannot open. However, the lid may open with lighter objects covering the lid which could cause damage to the lift mechanism or surrounding area.**

### Storage Tips

#### Cabinets, Roof Lockers, and Cubbies

Latching hardware (if equipped) keeps doors and drawers secure while traveling. To open doors and drawers equipped with secure latching hardware, press the spring-loaded knob inward until it pops out to use as a pull. When closing, push the knob back into the recess until the mechanism latches.

Exercise caution when storing items in cubby spaces and other open storage areas as they could dislodge

during travel. Heavy items could cause damage and even be dangerous should they dislodge while making sudden stops. Always secure cargo before travel. It is recommended to store heavier items in lower storage areas and lighter items overhead.

## **⚠ WARNING**

**Unsecured cargo can cause injury or lead to a vehicle accident and may damage the coach's interior should it become dislodged.**

## **⚠ WARNING**

**Keep flammable material away from appliances with burners and do not block vents.**

### **Pedestal Tables**

The Atlas Touring Coach has two pedestal tables. One table can be installed in front of the sofa while the other is installed between the driver and passenger seats. The table tops and pedestal legs are designed to be stored in the middle drawer of the sofa base. The tables leg can be inserted into the floor mounted threaded socket and rotated to lock in place. The top is installed by inserting the pedestal leg into the socket installed on the underside of the table top. To remove, simply pull straight up on the table top. The leg is removed by depressing the black button on the floor socket and rotating the table leg.

## **⚠ WARNING**

**Return table tops and pedestals to their respective storage positions before moving the vehicle. In a emergency stop or accident the top and pedestal could cause personal injury and/or death.**

### **Bar Cabinet**



The Tommy Bahama Atlas features a built-in bar cabinet designed with secure bottle storage for various bottle sizes as well as the included barware. Make sure everything is secured for travel before driving.

### **Driver and Passenger Seats**

The driver and passenger seats are provided by Sprinter, sent out to be recovered by Airstream to match the interior decor.

The seat adjustment mechanism provided by Sprinter allows the seat to be moved forward or backward and swivel left or right. Buttons near the door handle are used to move the seat forward and backward. Pressing down on the handle, centered under the front of the seats, allows the seat to swivel. Return the seat to the full upright position before using the swivel adjustment. The heated seats are activated by switches located on the door, next to the seat controls. For complete details on seat adjustments, please refer to the Sprinter manual.

### **Power Shades**

All Tommy Bahama models come with remote operated power blinds. The blinds feature a mechanical limit switch to prevent accidental loss or change of limits due to power surges or power outages. They will retain their pre-set limit stops even if the blind is pulled down manually by mistake. These presets are set at Airstream and shouldn't need adjusted. The power remote is also programmed beforehand and should only need reprogrammed if a blind has been replaced.

Refer to the Power Blinds owner's manual for operating and cleaning tips.

#### **Remote Instructions**

1. Select the channel for the blind to operate using the + and - selector on the remote.
2. To lower the blind fully press and hold the DOWN arrow for about 3 seconds or more, and then release.
3. To stop the blind in mid travel press the STOP button.
4. To tilt the slats in the blind press briefly and release the UP or DOWN arrow. Repeat until the desired tilt of the slat is reached.
5. To raise the blind fully, press and hold the UP arrow for about 3 seconds or more, and then release.

## **NOTE**

**The "P" channel will operate all blinds together.**



## Electrical System Overview

### Power Center



The Power Center is a self-contained 120 Volt AC (VAC) power distribution center utilized in recreational vehicles. It houses the coach's circuit breakers and fuses. Its primary function is to provide circuit protection for all the 120 VAC loads in the touring coach and is central to the overall electrical system.

The Power Center distributes 120 VAC power to appliances and receptacles. Inverter/charger output is routed through the breaker box to provide load safety protection. It also distributes 120 VAC to the inverter/charger to charge the batteries and power the 12-volt system.

The Power Center distributes incoming power from three sources: Shoreline power when connected to an external 120 VAC power supply (city power), onboard generator power, and the 12-volt house batteries via the 12V DC to 120 VAC inverter.

The power center is installed in the lower right hand section of the entertainment cabinet. Open the decorative door for access to 12-volt fuses and 120-volt breakers.

### **⚠ WARNING**

**The power center is a centralized power switching, fusing, and distribution center. The potential of lethal electrical shock is present in this box. Inadvertent shorts at this box could result in damage and/or injury. All servicing of this box should be done by a qualified Service Technician.**

### **⚠ WARNING**

**Disconnect/De-energize all main power service, shore power, generator power, and inverter power prior to servicing the breaker panel.**

### ***Circuit Breaker Protection***

Standard residential-style (resettable) circuit breakers provide circuit protection for all 120 VAC loads. Airstream has installed breakers per RVIA (NEC) listing requirements for the touring coach.

The 30 amp main breaker feeds individual branch breakers. The branch-breakers protect individual loads, which are identifiable by the affixed labels. Shutting off the main breaker will remove power to all branch loads (except for outlets/receptacles on the inverter circuit when the inverter is enabled, see GFCI this page).

A circuit breaker's ON/OFF switch function operates like a light switch: up is ON, and down is OFF. If an overload or short occurs, the breaker will snap to the OFF position to protect the connected circuit. As a result, any device running on the circuit will lose power. Before attempting to reset the breaker, consider the cause. If a connected device is faulty or uses a higher amperage than the circuit breaker's capacity, turn it off before resetting the breaker.

Before resetting the breaker, you need external AC power going to the breaker box. Firmly push the breaker switch to the OFF position and back to the ON position. If the breaker snaps back to the OFF position while resetting, a fault condition still exists and should be serviced by a qualified Service Technician. Suppose the breaker stays ON but snaps back OFF after turning on a possibly faulty appliance. In that case, a fault condition may exist in that appliance that will require service by a qualified Technician.

## Ground Fault Circuit Interrupter (GFCI)

The GFCI breaker provides reliable overload and short-circuit protection. GFCI breakers protect against ground faults and provide additional safety to the occupants of the touring coach on all outlets/receptacles. A ground fault occurs when current travels along an unintended path to ground, possibly through water or a person, which may result in an electric shock. The GFCI compares the amount of current going to and returning from the device plugged into the circuit's outlet/receptacle. When the amount of current going to the device differs from the amount returning, the GFCI interrupts the current within a fraction of a second, removing power from the circuit, and protecting the user.

Each GFCI circuit breaker is calibrated to trip with a ground current of 5 mA or more. Since most people can feel as little as 2 mA, a shock may be felt. The shock should be of such a short duration that the effects would be reduced, less than what would normally be a dangerous level. However, persons with acute heart problems or other conditions that can make a person particularly susceptible to electric shock may still be seriously injured.

While the GFCI circuit breaker affords a high degree of protection, there is no substitute for knowing that electricity can be dangerous when carelessly handled or used without reasonable caution.

The system incorporates GFCI breakers that implement an auto-self-test functionality. When turned off, these breakers require external AC power to be present before they can be turned back on. If power is present, and the breaker refuses to stay on, consult an electrician or certified RV technician.

### **⚠ WARNING**

**The GFCI circuit breaker will NOT reduce shock hazard if contact is made between a HOT load wire and a neutral wire or two HOT load wires. GFCI circuit breakers provide protection only to the circuit to which it is connected.**

## GFCI Breaker Test

Perform this test on the GFCI circuit breaker each month and record the date.

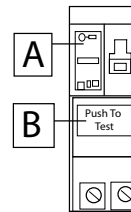

1. With handle A in the "ON" position, press PUSH TO TEST button B.
2. Handle A should move to the TRIP position, indicating that the GFCI breaker circuit is open.
3. Move handle A to the "OFF" position and back to the "ON" position to restore power.

If the device remains on when the Test button is pushed, the GFCI is not working properly or has been incorrectly installed (wired improperly). If your GFCI is not working properly, call a qualified, certified electrician who can assess the situation, rewire the GFCI if necessary, or replace the unit.

## Power Center Fuses

When blown, the fuses housed in the power center will be illuminated by a blown-fuse LED indicator to help determine which fuse needs replacing. The indicator will only illuminate if the affected circuit remains closed and/or has a load. For example, suppose a light is burned-out or the switch to the light is off, resulting in an open circuit. In this case, the fuse will not illuminate.

### **NOTICE**

**Most fuses will require a qualified technician to access and replace. Contact your dealer or Airstream Service Center.**

## Auxiliary Fuse Locations

In addition to the 12-volt fuses and breakers located in the power center, several components of the coach are protected by in-line fuses. These are usually located at or near the components they protect. There are also several fuses located under the driver and passenger seats. For additional information, [see 12-Volt Main Schematic on page 9-17](#).

## 120 Volt System

### City Power Overview

120-volt AC shoreline power (city power) enters the coach through the SmartPlug cordset connection to the power distribution center and inverter/charger. The inverter/charger acts as a pass-through and diverts 120 VAC to the 120-volt system (to operate the air conditioner, microwave, and 120 VAC receptacles) and converts 120-volt alternating current to 12-volt direct current to charge the batteries and power the 12V system.

All wires, components, and wiring methods meet federal and state requirements. The wiring is protected by circuit breakers when connected to external AC power. The circuit breaker panel for the 120 volt system is inside the Power Center; [see Power Center on page 5-9](#).

If an outlet or appliance is not working, check your touring coach circuit breakers and the breaker at the shoreline connection. If a breaker continues to trip after you have reset it several times, your circuit may be overloaded with devices/appliances, or there may be a short in the circuit. The Energy Management System (EMS) should shed loads to prevent breakers from tripping. If all else fails, try lessening the load on the circuit by turning off devices while using external appliances. If that does not solve the problem, consult an Airstream Service Center.

### Outlets and USB ports

Several 120V receptacles and USB charging ports are located throughout your touring coach's interior. An additional 120V receptacle can be found on the curbside exterior of the touring coach inside the forward utility compartment.

### Energy Management System (EMS)

The EMS controls 120-volt operated circuits to help keep the total 120-volt current draw to less than 30 amps. A detailed EMS manual is included with your owner's packet. When operating on generator power the 120-volt draw will be less than 20 amps. These circuits may be any type load, but are typically heavier loads, those whose use can be "postponed" until a time when current is available for their use.

### Operation

When 120 VAC and 12 VDC are initially applied, the system will energize the relays at one second intervals, closing the normally open contacts on each of the relays while monitoring the total current. If the total

current should exceed the service limit, the system will shed (turn off) 120 VAC loads starting with the A/C unit followed by the microwave. As it does this, it calculates the amount of current that was removed, which is the value for that load. This value is placed in memory. The system has "learned" the amount of current that particular appliance draws. This feature compensates for the difference in current draw over a range of line voltage and ambient temperature, by relearning the load each time it is turned off.

The system now waits until the total current is lower than the service limit, by the amount in memory, before it will turn that load back on. This ensures that there is sufficient current to operate the load.

### Display Panel



The Energy Management System display is located in the entry cabinet behind the passengers seat. The display panel requires little user interaction and is provided to help the user understand power management. The display monitors the total AC current of the touring coach and prevents circuit breaker tripping by momentarily shedding loads. As additional appliances are turned on the system will begin to shed loads. As appliances are turned off, and a minimum of two minutes has expired, the system will automatically restore power to each of the shed loads.

### Service

The "Select" button allows the service type to be set to either 15, 20, or 30 amps to match the incoming service.

When power is first applied, the system will be in the 30 amp mode and the screen will display "Service 30A". Momentarily pressing the "SELECT" button will switch the system to the 20 amp mode. Momentarily pressing the button again will switch the system to the 15 amp mode.

Press the "SELECT" button to switch to either 15 or 20-amp service if it is necessary to use an adaptor or you know the shoreline power is 15 or 20 amps. The screen will display either "Service 15A" or "Service 20A".

## Interior

The generator supplies 20 amp service and is set to switch the system automatically to the 20 amp mode whenever the generator is the power source. The screen will display “Generator 20A” when the generator is supplying power.

### Status

The rooftop A/C unit and microwave are set at the factory to be the controlled circuits and are shed in this order.

This means if a power hungry appliance is plugged into an outlet and the system begins to use more than 30-amps it will begin to shed loads and will first shut off the electric heating element followed by the A/C unit.

### 12 Volt System

Battery charge voltage is the primary concern when using only battery power (boondocking). Charge status of the house and chassis batteries are displayed as voltage on the home screen of the Multiplex panel.

Everything except the A/C, outlets, and microwave runs on 12 volt power (note: some of these appliances have 12 volt electronic boards and require 12 volt power to operate).

Power is routed from the house batteries to the 12 volt distribution panel and through its branch circuits to the rest of the touring coach. All 12 volt current is routed to a 12 volt fuse block. Power from the fuse block goes to a busbar holding Type 2 thermal breakers. The thermal breakers feed electrical components throughout the touring coach.

### ⚠ CAUTION

Thermal breakers break contact when overheated by a short or overload in the wiring. These breakers automatically reset when cooled down. A breaker continually overheating and breaking contact should be investigated by a qualified service technician.

### NOTE

The engine battery and house batteries are isolated from each other, preventing the two systems from drawing down simultaneously.

### NOTICE

Airstream does not recommend the vehicle engine be run at idle speeds for more than one hour between 15 minute full temperature drive times.

## Solar System



The rooftop solar panels installed on your Airstream help maintain battery health, reduce operating expenses, and extend the battery life of the house and chassis batteries. House and chassis batteries are charged via dedicated panels. The solar system's solar charge controllers gather energy from the individual solar panels and store it in your batteries. The system features a display located in the front roof locker behind the drivers seat that allows you to view live status information like solar watts and battery voltage.

To optimize solar charging, ensure the panels are clean and not shaded by trees or structures that might block the sun. Please refer to your owner's packet for reference material that discusses the solar system and its operation.

### NOTICE

Do not unlock or tamper with the MPPT Control system settings. Changes to the settings will negatively affect the system's performance and could damage your batteries.

### NOTE

The solar system is designed to assist with normal means of charging and to help slow battery discharge; it is not designed to charge a dead battery. If the chassis battery is below 11.5 volts, it must be charged by other means.

### NOTE

All current flowing into and out of the battery must travel through the shunt. Do not connect the negative wiring of aftermarket add-ons to the battery's negative terminal or between the negative terminal and the shunt, as this will cause inaccurate display readings.

For more information, see [12-Volt Main Schematic on page 9-17](#).

## Electrical System Operation

Your touring coach has two 100Ah 12V LiFePO4 deep cycle house batteries with built in battery management, an inverter/charger, and vehicle alternator. These components work in conjunction to provide a seamless experience whether hooked up to shore power, boondocking on battery power, or driving to the destination.

The information in this manual touches on the highlights of the system, its components, essential functions, and operation. Before operating the system review the Inverter/Charger and Battery information in your Owner's Packet for important warnings/limits, operating instructions, and tips for using the batteries.

### Battery Disconnect Switch



The battery disconnect switch is used to separate the house batteries from the 12-volt distribution panel and charging system. The battery disconnect switch is equipped with LED indicators. When the light is green the switch is ON and the batteries are charged. When the red LED begins to blink slowly it is an indicator the batteries should be charged. If the red LED begins blinking rapidly the batteries should be charged immediately to avoid potential damage.

### NOTICE

**A rapidly blinking red LED indicates the battery charge is below 50 percent and future charging damage may incur. Airstream recommends charging the battery as soon as you notice the light blinking.**

When connected to an external AC power source via a shoreline connection, the inverter/charger will charge the house and chassis batteries and supply 12-volt DC power to the 12-volt system regardless if the battery disconnect switch is in the ON or OFF position. Likewise, the generator, alternator, and solar panels will charge the house and chassis batteries regardless of the battery disconnect switch position.

If the touring coach is NOT plugged into an external AC power source and the switch is turned to OFF the batteries are disconnected and the 12-volt system will not have power. The OFF position is intended for storage of the touring coach or when power conservation is desired.

### NOTE

**As a safety precaution, the electric gas shut-off solenoid closes automatically when 12-volt power is disconnected, cutting gas to appliances. It will reopen when power is restored.**

## House Batteries



Two 100Ah 12V LiFePO<sub>4</sub> deep cycle house batteries provide onboard power. They are located under the coach behind the driver and passenger step wells.

The following is an overview of the batteries and battery management system. Please read the Battle Born manual (in your owner's packet) to learn more about using and maintaining the batteries. For additional information, scan the QR code above to visit <https://battlebornbatteries.com/>.

Lithium-ion batteries are superior to traditional lead-acid batteries in many ways. They provide longer life, faster charging, more usable energy, and have a lifespan of approximately 3000-5000 cycles.

A full discharge and recharge of a battery defines a cycle. The number of cycles a lithium-ion battery can sustain varies depending on its usage. A battery that is consistently discharged to only 50% SOC will have more cycles than a battery that is frequently discharged to 0% SOC.

To learn about the various methods of charging the batteries, see [Battery Charging on page 5-18](#).

### **⚠ WARNING**

**The battery manufacturer's manual in your owner's packet contains detailed operating instructions and important safety information. Please read the manual before using the batteries.**

### **Battery Management System (BMS)**

The BMS is an internal component of the batteries and is crucial to ensuring safe operation. The BMS monitors cell voltages, currents, and temperatures to ensure they operate in a safe range and will shut the batteries down should any faults occur. The following are features of the BMS:

- Over/under voltage protection
- High current protection/short circuit
- High-temperature protection
- Low-temperature charging protection
- Cell balancing

### **High Voltage Disconnect**

If an individual cell voltage exceeds a prescribed threshold during charging (approx. 14.7V), the BMS will prevent a charge current from continuing. Discharge is always allowed under this condition.

### **NOTICE**

**Even though the BMS will protect against issues from overcharging, it should be avoided. The recommended specs are 14.2-14.6 bulk/absorb and below 13.8 float.**

### **NOTE**

**If a battery has not been balanced for a long period, a high voltage disconnect could occur at a lower voltage. The battery will rebalance after several full charges.**

### **Low-Voltage Disconnect**

If an individual cell falls below a prescribed threshold during discharge (approx. 10.5V), the BMS will prevent further discharge. Should this occur, connect the coach to external power using the shoreline power cord to bring the affected battery out of the low-voltage disconnect condition, and fully charge. Bringing a battery out of low-voltage disconnect only "wakes" the battery and allows it to accept a charge. Without shore or generator power, the battery may go back into low-voltage disconnect.

### **NOTICE**

**The manufacturer states you should charge (wake) your battery within 24 hours of entering low-voltage disconnect; otherwise, you risk damaging the battery and voiding the warranty.**

**Battery Charge**

The heated batteries consume an average of 1.8 amps. Testing indicates, that at 0°F, with no insulation, the heater would be on about 30% of the time. With no other loads or charging, the batteries would give approximately 185 hours of heat capability before the batteries would go into LBCO shutdown.

| Voltage | Capacity | Amp Hours Remaining |
|---------|----------|---------------------|
| 14.4V   | 100%     | 200                 |
| 13.6V   | 100%     | 200                 |
| 13.4V   | 99%      | 198                 |
| 13.3V   | 90%      | 180                 |
| 13.2V   | 70%      | 140                 |
| 13.1V   | 40%      | 80                  |
| 13.0V   | 30%      | 60                  |
| 12.9V   | 20%      | 40                  |
| 12.8V   | 17%      | 34                  |
| 12.5V   | 14%      | 28                  |
| 12.0V   | 9%       | 18                  |
| 10.0V   | 0%       | 0                   |

**NOTE**

Values are based off a testing environment with the batteries at 100% capacity.

**Temperature Limits**

- The battery has an operating temperature range of -4°F (-20°C) to 135°F (57.2°C).
- The BMS will not allow a charging current under 25°F (-3.9°C) but will continue to discharge down to -4°F (-20°C).
- The BMS will not allow a charging or discharging current if the internal temperature of the battery has reached 135°F (57.2°C)

**Cold Weather Usage**

The house batteries have internal heaters that will engage when battery temperatures drops below 35°F (when the battery disconnect switch is ON). Depending on the temperature, the heating element will automatically engage and disengage and does not require any user input.

**NOTE**

The BMS will not allow a charging current if the internal temperature is below 25°F, and it will not allow charging or discharging current above 135°F.

**NOTE**

If a battery is in low-voltage disconnect mode and the battery temperature is below 35°F, the heat function will need some time to warm the battery before performing the wake-up procedure.

## Inverter/Charger



The Inverter/Charger is a DC to AC inverter and a 50-amp multi-stage battery charger. The charger is derated to 80% (40A) for the Energy Management System. It has a remote control module mounted in the cabinet at the entry door behind the passengers seat.

The Inverter/Charger charges the batteries and converts 12-VDC to 120-VAC current for distribution to the entertainment devices. To operate your entertainment circuit the inverter must be ON, unless connected to generator or shoreline power.

If power is not needed to the entertainment circuit make sure the inverter is turned OFF to conserve battery power. The inverter will have a slight power draw even when turned off but the power consumption will be even greater if left on.

### **⚠ WARNING**

**An extensive owner's manual for the Inverter/Charger is provided in the Airstream Owner's Packet. Make sure to read, understand, and follow all information, notes, Cautions, and Warnings in the manual before operating the Inverter/Charger. All settings are calibrated at the factory and should not be adjusted.**

## Generator



The onboard generator makes your RV house electrical system fully self-contained. It allows you access to 120 volts when there is no shore power available. To use the generator you simply start it. All switching is done automatically. The generator can be started by pressing the start button on the switch in the overhead compartment behind the passenger's seat or on the multiplex panel (as shown above).

### **⚠ DANGER**

**Do not operate the generator in an enclosed building or a partly enclosed area such as a garage. Nor should the generator be operated while sleeping. Follow all instructions and warnings in this manual and the generator manufacturer's manual.**

The generator requires periodic maintenance, [see Maintenance Schedule on page 9-2](#).

### **⚠ WARNING**

**An owner's manual for the generator is provided in the Airstream Owner's Packet. Make sure to read, understand, and follow all information, Notes, Cautions, and Warnings before operating.**

### **NOTE**

**It is easier on your generator and appliances if you allow the generator to reach its normal operating speed (about a minute) before applying heavy current loads.**



**Automatic Generator Start (AGS)**

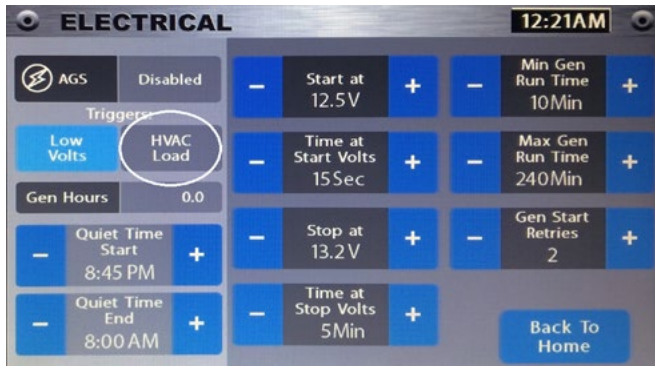

Your Touring Coach is equipped with an Automatic Generator Start System (AGS) which provides an optional automatic control of your onboard generator. The purpose of an AGS system is to automatically start (and run) the generator when the 12 volt electrical system (house batteries) drops to a pre-determined level. The AGS can be enabled to monitor the house battery bank and when it reaches a certain level, the generator will automatically start, sending a charge to your batteries. This protects the system so that your batteries will not go down farther. Once the batteries receive a sufficient amount of charge, the generator will automatically turn off. If you are in a location for an extended period of time, this can help protect the battery bank when shore power is not available.

The automatic start function of your generator requires you to manually enable it. This can be accomplished by selecting “Auto Gen Start Enable” on the Multiplex display and then pressing “on”. You will need to make sure that the “HVAC Load” button is activated.

Once enabled, AGS will remain enabled until the Sprinter Ignition is cycled or the generator is manually operated. After the vehicle is started, the AGS will be disabled. You can then return to the cabin to manually re-enable the system. It will then remain active until the vehicle is turned off. Any cycling, on or off, of the vehicle ignition will disable the AGS functionality.

If the generator is manually stopped while running and in an Auto Gen mode, it will disable future auto gen starts until re-enabled at the multiplex screen. If you manually start the generator when Auto Gen is enabled, it will disable the future auto gen starts until re-enabled at the multiplex screen.

Carbon Monoxide (CO) is a highly poisonous gas. Moving Parts and electricity can cause severe personal injury or death. To reduce exposure to these hazards, always disable AGS before

1. Sleeping in vehicle, unless equipped with a working Carbon Monoxide detector
2. Parking vehicle in a garage or confined space
3. Parking vehicle for storage
4. Servicing generator, batteries or other electrical appliances
5. Fueling vehicle

**⚠ DANGER**

**Exposure to carbon monoxide, moving parts, and electricity hazards are possible due to unexpected starting of generator while in Auto Start mode; see [Basic Generator Safety Information](#) on page 2-8.**

## 120-Volt Automatic Switch Over Box

The switch over box automatically switches the 120-volt feed to the Energy Management System Module from shoreline to generator and back as you choose which way to power the touring coach. You simply decide whether to plug into a 120-volt shoreline or start the generator and the box will do the rest. If the generator is accidentally started while plugged into shoreline the box will sense the generator incoming power. Contact points inside the box will switch, cutting the shoreline connection and establishing the generator connection. This protects the system from a possible overload from dual power sources.

### Generator/City Power

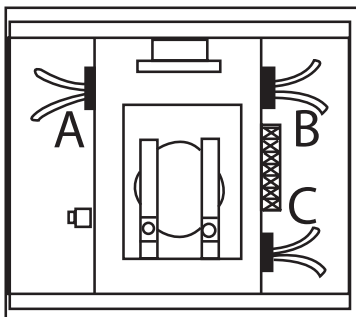

- a. To Energy Management System module main breaker
  - b. From generator
  - c. From shoreline
1. When plugged into shoreline power, the current path is from C to A.
  2. When you start your generator, the points switch and the power flow is from B to A. Stopping the generator releases the points back to shoreline feed.
  3. If you're plugged into shoreline and you start the generator, the points still switch since the generator has the priority, so the current flow is still B to A.

## Battery Charging

Because runtime varies based on demand and environmental factors, the best way to ensure enough battery power remains is to monitor the battery voltage charge display on the Multiplex home screen; for more information, [see Multiplex System on page 5-20](#).

The most significant loads on the batteries are air conditioning and microwave use. The more these systems run, the more energy consumption.

If inverter use is extensive, the house batteries will deplete much quicker. Even when not using 120 VAC power, the inverter will draw a small amount of power if left on. When not in use, turn the inverter off to conserve battery power. Consider reducing the temperature on the thermostat when using the heater and increasing the temperature on the thermostat when using the air conditioner. If you plan on staying longer without access to a charge, you will want to conserve your battery power by using as few lights and appliances as possible.

### Charging via Shoreline Connection

Plug the Smartplug Cordset (shoreline power cord) into an external shoreline power supply (city power). Check that the cordset LED indicator light is blue and plug the other end into the coach's roadside SmartPlug inlet; [see Shoreline Power Inlet and Cordset on page 6-8](#).

The 30A automatic transfer switch with shore power sensing capability provides total electrical protection from faulty external power sources. It also automatically determines the shore power connection amperage, which means no manual setting is necessary.

In some older parks and other locations where three-pronged outlets are not available, certain precautions to ensure proper grounding and polarity must be taken. These precautions are listed below:

1. Attach the three-pronged plug to a two-pronged adapter. The third conductor line of this adapter has a short wire lead that must be grounded.
2. For proper grounding, connect the short ground lead to a grounded outlet box or to a cold water pipe. When no water pipe is available, drive a metal rod two feet into the ground and attach the ground lug to it, thus providing the unit with proper grounding.

### NOTE

**When the three-pronged plug can be used, there will be no problems with proper polarity or grounding with a properly-wired shoreline outlet.**

As an RV owner, you may want to install a 30A 120 VAC outlet in your home so you have a shore power hookup readily available. However, you must have the proper outlet installed. Typical household 30A outlets are wired 240 VAC for home appliances. **RV outlets are 30A 120 VAC.** Ensure your electrician is aware of the difference, or they may mistakenly wire the outlet to 240 VAC.

### NOTICE

**Do not connect to a 240 VAC outlet. Connecting to a 240 VAC outlet may result in permanent damage not covered by warranty.**

#### **Charging via Generator**

All generator functions are controlled via touchscreen input at the Multiplex panel. For additional information on generator operation and charging using the generator, [see Generator on page 5-16.](#)

### NOTE

**The system will only allow the generator to run until the battery reaches a 95% charge to avoid running the generator indefinitely.**

#### **Charging via Alternator**

The vehicle alternator will provide a charge to the house batteries. All switching is handled automatically so one need only drive the coach to provide a charge. Charge times will vary depending on current charge and environmental factors.

### NOTICE

**In the event the engine battery is depleted, Sprinter recommends using a trickle charge only when charging the battery. When jumping the engine battery, do not use a power boost. Read and follow battery charging procedures in the Sprinter Owner's manual.**

#### **Charging via Solar Power**

The solar charging system is primarily used to help maintain a charge between shoreline, generator, or alternator charging. The solar system is automated and does not require input from the user.

### NOTE

**The solar panels and charge controllers are designed to help maintain a battery charge, and are limited in their ability to provide a charge to the batteries.**

#### **Charging the Chassis Battery**

There are several ways the chassis battery gets charged. It can be charged by connecting to shoreline power or running the generator. Both of these methods maintain the chassis battery charge with an integrated trickle charger. When the engine is running, the alternator charges the chassis battery. Finally, the chassis battery receives a solar charge from a dedicated solar charge controller.

## Multiplex System

The Firefly Multiplex System provides advanced automation and mobile electrical solutions for your touring coach. Firefly is a multiplex network system that combines multiple signals across a media to reduce wires and simplify end-user control. The system combines all desired functions and controls of the touring coach into a simple touchscreen interface that allows you to control many systems.

Each button illuminates when pressed, indicating the circuit is either ON or OFF. The button will turn white when the circuit is OFF and blue when it is ON. Buttons controlling circuits such as Light Master and Panel Lights typically do not change from blue to white.

### Systems Controlled By Firefly

- Lighting (inside and outside)
- Power awning and awning lights
- Slide-out
- Skylight
- TV lift
- Skylight
- Climate
- Tank monitoring (Fresh, Black, Grey and LPG)
- Battery voltage
- Tank heaters
- Water pump

There are several touchscreen control panels for the multiplex system. The central (main) touchscreen control panel is mounted above the passenger seat at the entrance, with remote touchscreens placed throughout the touring coach. While all screens have controls for all the major systems, the central panel has additional status and system information features not found on the secondary panels.

### NOTE

**The Multiplex System is self-resetting should a circuit trip. The owner should never need to reset the system for any reason. If the main control panel or remote panels are not operating, this could indicate a short in the wiring that will require service by a certified technician.**

## Multiplex Home Screen/Monitor Panel



The Home screen displays fluid levels of the Fresh Water, Grey and Black Water, and LPG tanks. All fluid monitoring systems are factory calibrated to the tank capacities of each model. Sender pads are installed and adhered to the sides of the holding tanks. The sender pads scan the level through the tank wall using the sender's microprocessor programming. The Home screen also displays the status and settings of the major systems of the touring coach, including the voltage status of the House and Chassis batteries.

### Multiplex Secondary Screens

The navigation bar on the left side of the screen allows you to select from several secondary screens: Lights, Electrical, Climate Control, Awnings & Lifts/Auxiliary [slide-out, awning, skylight, TV lift], and finally the Settings screen (see next page for examples). From here, you can navigate to additional screens that serve a variety of functions.

### NOTICE

**You may encounter Warning screens when entering settings. Some Changes will affect functions of the touchscreens and your touring coach and should only be changed by a trained technician.**

### Cleaning the Multiplex Touchscreens

To clean the glass surface of the LCD touchscreens, power down the system and then gently wipe it with a soft, slightly damp cloth (using ONLY minimal amounts water or lens cleaner). Ensure the LCD is fully dry before powering the system up again.

### NOTICE

**The components of the Firefly system must not be exposed to liquids or moisture of any kind (including the use of any cleaning agents). The only approved exception is cleaning of the glass surface of LCD touchscreens.**

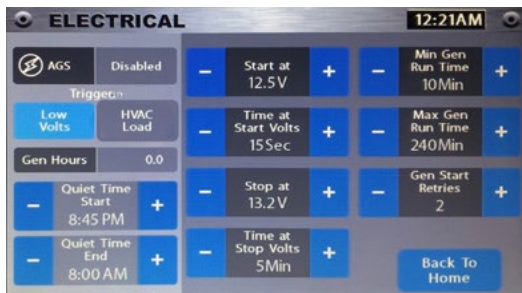

Screen images may vary slightly with continuous improvements/firmware updates

## Lighting

The Multiplex System touchscreens control the LED lighting throughout your Airstream. The “Home” and “Lights” screens have a “Light Master” switch that will allow you to instantly turn all the interior lighting in your touring coach, on or off.

Light Master Memory Feature:

The Light Master function has a memory. If you turn off individual lights and then press Light Master OFF, it will recall what lights were on the next time you press Light Master ON, and only those lights will come on. Hold the Light Master ON for more than 1 second to reset the memory and turn on all the interior lights.

Light Master **LOCK** Feature:

If Light Master OFF is held or pushed twice, the Light Master On will not respond. Hold the Light Master ON to resolve.

### NOTE

Since your Airstream has LED lighting, there are no lights to change. If an LED light stops functioning, it will require service or replacement.

## Multiplex Bluetooth® App

If your multiplex system is bluetooth equipped, the system can be controlled wirelessly via Bluetooth® connection using the Vegatouch Mira app while in proximity to the touring coach. Follow these instructions to download the app and connect via Bluetooth®:

1. Go to the settings screen on the multiplex panel inside your touring coach and tap the gear icon.
2. Select “mobile app” to reach the Mira information page where the required PIN is displayed.
3. Scan the QR code, download the app, and follow the on-screen instructions to connect using the PIN.

If you are unable to scan the QR code, search your app store for Mira, or select one of the following icons:



## ⚠ CAUTION

Warning alarms have been incorporated into the Multiplex System to warn of possible hazards. These warning alarms include; cabin door lock, slide-out extended, cabin door open, luggage door locks, chassis battery voltage, and folding step. If an alarm sounds check the main Multiplex control panel for a warning notification before proceeding.

## Entertainment Systems

### Digital Media Player

 Your touring coach has a Fusion® Stereo with an LCD color display. The stereo features several source options, such as Bluetooth®, FM radio, AUX, and USB connections.

Download the Fusion-Link Remote Control App to adjust the volume, change the source, and control other stereo functions. See the Fusion Quick Start Manual for complete operating information.

The Fusion-Link app is free to download. Scan the QR Code above, search for Fusion Link on your device's app store, or click on one of the following icons:



### NOTE

If the main “battery disconnect” switch does not power off the radio it will need to be turned off by pressing the power button on the radio.

### Subwoofer

A dedicated volume control is installed under the passenger's seat. Use the control to raise or lower the subwoofer to the desired volume.

### Video

The Atlas Touring Coach is equipped with a LED HDTV and is pre-wired for a Blu-Ray player.

### TV Operation

The TV is stored in the entertainment cabinets counter top and is raised or lowered by pressing the TV lift UP/DOWN buttons located on the side of the cabinet. A hinged lid will open to allow the TV to raise from the cabinet. Multiplex control panels can also control the TV's movement through the “Auxiliary” screen. Press the “TV lift” button's up or down arrows to raise or lower the TV.

### NOTICE

Before raising the TV make sure the counter top is clear to avoid damage.

### TV/Radio Antenna



The roof-mounted TV/Radio antenna receives free Local VHF/UHF TV signals and FM radio signals. The signal is boosted to maximize signal strength and provide TV and radio reception.

The antenna booster is controlled by a switch on the antenna booster's wall plate inside the roof locker above the passenger seat. Press the small pushbutton on the wall plate to turn **ON** the booster. An LED indicator will illuminate to show the booster is active. To view cable or satellite, you will need to turn it **OFF**.

The antenna is constructed of durable automotive-grade plastic that is UV-protected, weatherproof, and capable of withstanding outdoor climates. Clean the antenna with mild soap and water only. Do not powerwash or use harsh cleaning solutions, solvents, or alcohol to clean the antenna or antenna base.

### Antenna Pre-Wiring

#### Roof Mounted Satellite

The touring coach is pre-wired with a coax and power cable for a roof mounted satellite TV antenna. One end of the cable is coiled behind the Multiplex main control panel and is accessed by removing the screws from the side panel inside the front roof locker. The other end is coiled above the microwave. Remove the microwave to access the coax and power leads. A receiver can be placed inside the front roof locker.

#### Portable Satellite Antenna



### External Hookup

You can establish a cable TV or satellite connection by attaching a cable TV service provider's coax cable, or a satellite coax cable, to the external roadside cable/satellite inlet.

**Viewing Cable:**

To view cable, turn **OFF** the antenna booster by pressing the small round pushbutton on the antenna booster’s wall plate (located in the roof locker above the passenger seat). To return to viewing a boosted antenna signal, press the button **ON**.



**Connecting and Viewing Satellite:**

Follow the steps below to hookup a satellite receiver and view satellite TV:

1. Remove the short coax cable jumper from the dual coax wall plate’s connectors (in the roof locker above the passenger seat).
2. Connect a coax cable (user supplied) from the wall plate IN to your satellite receiver input.
3. Connect a second coax cable (user supplied) from your satellite output to the wall plate OUT.

To view satellite TV, turn **OFF** the antenna booster by pressing the small round pushbutton on the antenna booster’s wall plate (located in the roof locker above the passenger seat). To return to viewing a boosted antenna signal, press the button **ON**.

**Starlink Internet/Wi-Fi**

 Starlink Roam provides Wi-Fi internet access while traveling to your destination and in  locations where connectivity is unreliable or unavailable. For Starlink to function, the inverter must be on, or the coach must be connected to shoreline power.

For more information about Starlink’s capabilities and coverage, scan the QR code above, click the Starlink app icon below, or visit <https://www.starlink.com/roam>. To set up access and enroll in a month-to-month Starlink subscription, download the Starlink app from the link above, or click on one of the following icons:



**Starlink Antenna Heater**

Starlink’s in-motion phased array antenna has a built-in heater that activates based on internal temperature and signal loss (to melt ice or snow that may be causing interference). If the signal is lost, the heater may start without ice or snow, even in warmer weather.

The heater will draw power from the batteries when using only inverter power (boondocking). It can be turned off in the Starlink app to conserve battery power. Provided you have a good signal, Starlink will still function.





If you do not have the Starlink app, you can unplug Starlink’s power cord at the back of the opening on the right side of the entertainment center to prevent the heater from turning on. If you plan to use it again, ensure it is plugged back into the same outlet so it is on the inverter circuit and not an EMS-controlled outlet (see above).

Clean the antenna with mild soap and water only. Do not powerwash or use harsh cleaning solutions, solvents, or alcohol to clean the antenna or antenna base.

**NOTE**

**The roof-mounted Starlink dish requires a clear view of the sky to connect.**

**Airstream Connected RV Antenna Pre-Wire**

 Your Airstream is pre-wired with a Connected RV high gain, multi-band antenna. This  antenna, along with the Airstream router (sold separately), provides access to the internet by creating a local area network. For more information, scan the QR code above or visit <https://www.airstream.com/connected/>. Stay connected to the amenities you demand with a boosted Wi-Fi signal or a dedicated 4G LTE-A internet service (requires data plan activation). Contact your preferred dealer’s service department to schedule your installation.

**NOTE**

**When purchasing an Airstream router to activate the Connected RV features, a data plan will be required. Instructions on setup and data plans will be included with the router.**

## Appliances

All appliances are delivered to Airstream, Inc., with in-depth owner's manuals. Those manuals are included in the delivery case supplied by your dealer. The manuals may contain Warnings, Cautions, and operating instruction that should be read and followed before operating the appliances.

The information contained in the appliances manuals supersedes any information contained in the Airstream Atlas Owner's Manual on appliances. If you believe contradictory information on appliances is contained in this manual, or if any appliance manual(s) have not been provided with your vehicle, contact your dealer, the respective appliance manufacturer, or Airstream Customer Service at 937-596-6111 or write:

Airstream Factory Service Center

428 W. Pike Street

P.O. Box 629

Jackson Center, OH 45334-0629

(937) 596-6111

## Maintenance

Follow the instructions and Warnings noted in the respective appliance and equipment owner's manuals, as well as those mentioned below.

Annual maintenance should be conducted on propane gas appliances and equipment by an authorized dealer or repair facility.

Insects can build nests in the burners of various appliances and equipment. The burner and burner orifice of the propane gas appliances and equipment should be cleaned by an authorized dealer or repair facility any time circumstances or conditions warrant, but no less than on an annual basis.

### **⚠ DANGER**

**Most LPG appliances used in recreational vehicles are vented to the outside of the vehicle. When parked close to a gasoline pump, it is possible that gasoline fumes could enter this type of appliance and ignite from the burner flame, CAUSING A FIRE OR AN EXPLOSION.**

### **⚠ CAUTION**

**Airstream recommends shutting off the LP gas supply before refueling the vehicle or entering a refueling station.**

## Air Conditioner

The roof A/C used on Airstream's Atlas has one of the lowest profiles of any A/C on the market today. Coupled with a fiberglass basepan this lower profile and lighter weight means less drag and improved fuel efficiency. In your owner's packet is a set of literature covering all operating and maintenance instructions. If the literature is misplaced, contact the A/C manufacturer or your Airstream dealer for replacement.

Proper voltage to the A/C is critical. A volt meter check may find voltage much lower at a campground shoreline outlet than the needed 110 to 120 volts. Low voltage is usually associated with older or poorly maintained motorhome parks. Parking your touring coach so the power cord can be plugged in to a receptacle close to the fuse or circuit breaker box can alleviate low voltage problems. Avoid extension cords and adapters whenever possible. If an extension cord must be used, it should be as short and heavy as possible to provide the most current.

If high temperatures are expected, make an effort to park in a shaded area. Starting the A/C early in the morning also helps. It is more efficient to hold a comfortable temperature than it is to lower the temperature after the interior of the touring coach is already hot.

### **NOTICE**

**Clean filters weekly when A/C is in full use.**

## Heat Pump

Your air conditioner has a built in heat pump designed to take the chill out of the air. To turn on, select "Climate" from the main Multiplex control panel and set mode to "heat pump". Set the thermostat to your desired temperature.

### **NOTICE**

**Review the air conditioning literature supplied in your owner's packet before proceeding.**



### Cooktop

There is little difference between the operation of home gas ranges and the touring coach's cooktop. If, however, you are used to an electric range, operating confidence can be quickly gained by reading the manufacturer's directions provided in the owner's packet. Manufacturer's service and parts manuals are also available.

#### **WARNING**

**If the operation manual for the cooktop has not been provided with your touring coach, contact the listed manufacturer to obtain. Their manual contains specialized Warnings and Cautions that should be reviewed prior to operating the appliance.**

### Ceiling Vent Fan



The high-volume roof vent system is designed to quickly exhaust stale, hot air and draw in fresh air. It is great to use when the outside temperature does not call for air conditioning, but heat has built up in your touring coach.

The core of the system is a powerful rotary fan that works with a slightly open window to create a balanced airflow. It is designed for maximum air exchange, minimum sound levels and power consumption. Fresh, clean, natural air is pulled in. Hot, stale, stuffy air is pushed out. The vent can reduce the use of air conditioning allowing you to breath natural, fresh ambient outside air.

#### Operation

1. Open dome approximately 3 in. or more (ceiling fan has a built-in safety switch that will not allow motor to operate unless dome is partially open).
2. Turn 3-speed knob to desired performance level (3-Low, 2-Medium, 1-High, O-Off).
3. Open window(s) or door for airflow.

The source of airflow is determined by the number of window(s) or doors opened. For best results, close all roof vents and open one window that is the greatest distance from the ceiling fan.

#### **NOTICE**

**Never place Lindeen™ or a like cover over ceiling fan. Greatly restricted airflow and increased sound levels will occur.**

#### *Thermostat and Rain Sensor*

The fan is equipped with a built-in thermostat. Select your comfort setting and the fan will automatically turn on and off as your touring coach heats up and cools down. When the rain sensor becomes wet the dome will close automatically and shut the fan off. Once the sensor has dried out the dome will reopen and the fan will restart.

1. Follow the previous operation steps one through three.
2. Select the desired temperature or comfort level using the thermostats knob. The fan motor will now start and stop automatically as the interior temperature of coach exceeds or drops below the selected level.

#### **NOTE**

**Fan motor will not start if temperature selected is warmer than interior temperature of coach.**

#### *Cleaning Instructions*

1. Turn fan motor off.
2. Remove the screws around perimeter of screen insert only.
3. Clean screen with soap and water solution, dab dry with a soft cloth, and reinstall.

#### **NOTICE**

**Do not use petroleum containing additives or solvent based products on any of the vent's components or its corrosion resistant hardware.**

#### **NOTICE**

**This product has been manufactured using prime UV stabilized Polymers for maximum toughness and durability. However, the use of non-compatible chemicals will cause cracking and product failure. Please refer to the user's manual provided in your owner's packet for more information.**

## Furnace

The manufacturer of the furnace in your touring coach has been well known in the motorhome industry for many years. The furnace burns LP gas, and is powered by 12-volt current. Operating instructions are located in your owner's packet. If they should become misplaced, new literature can be ordered directly from the manufacturer or your Airstream dealer. The manufacturer also offers a detailed service guide for your furnace.

The furnace is located below the curbside wardrobe cabinet in the bath area and can be accessed by removing the false panel. The furnace is controlled by the Main Multiplex Control Panel located on the wall at the entry door.

### **⚠ WARNING**

**Carefully read all the manufacturer's instructions prior to operating. NEVER store flammable material next to the furnace or in close proximity to the furnace exhaust outlet on the side of the touring coach.**

### **NOTICE**

**If warranty service is required, use only a service location recommended by the furnace manufacturer or your Airstream dealer.**

## Microwave Ovens

Refer to the Certified Performance Checkout sheet, included in your owner's packet, for manufacturer, model, and serial number information.

## Refrigerator

Review all refrigerator literature supplied in your owner's packet or stored in the refrigerator prior to operating it.

### **Operation**

The refrigerator operates on 12-volt current from the batteries. All units are supplied with a wide range thermostat designed to sense the evaporator (cold plate) temperature. The coldest position on the thermostat is reached by turning the knob to the right (clockwise); conversely turning the thermostat knob to the left (counterclockwise) yields a warmer setting. The OFF position is reached by turning hard counterclockwise past the click. The reference point is shown with an indicator sticker beside the knob.

### **Start up**

Turn the power on and set the thermostat between 3 and 4. You can make further adjustments to suit your personal requirements after the box has cooled down. Allow the refrigerator to come down to temperature before loading with product. Adding pre-cooled product will help keep the temperature stable when loading. Setting the thermostat to a higher setting e.g., 7, will not decrease the time required for the unit to cool down to its normal operating temperature.

### **NOTE**

**The refrigerator requires 12V power to operate. You must have the battery disconnect switch in the ON position, even if plugged into shore power.**

### **Defrost and Cleaning**

The frequency of defrost is dependant on the number of door openings, the ambient temperature and the humidity level. Typically, it is a good practice to defrost once there is ¼ inch of frost buildup on either side of the evaporator (cold plate). When defrosting, the unit is shut off by turning the thermostat counterclockwise to the OFF (0) position. Prop the door open. We suggest placing a towel in the bottom of the refrigerator to catch excess moisture.

Now that the unit has been defrosted, the interior can be cleaned with a non-abrasive cleaner. Do not use "Brillo" or "SOS" type abrasive pads, as they will score the surfaces. Baking soda is recommended.

### **NOTICE**

**Speeding up the defrost process with a knife or scraper is strongly discouraged due to the likelihood of rupturing the refrigerant circuit.**

## Skylight

The Atlas Touring Coach is equipped with a weather resistant, insulated skylight. The skylight can be conveniently controlled by the main Multiplex control panels "shades" screen.

### Water Heater

The Atlas Touring Coach is equipped with a continuous water heater featuring 60K BTU output, freeze protection, and direct spark ignition. The tankless water heater monitors inlet water temperature and flow, and output water temperature and flow.

Below is a representation of normal operating valve settings. When the valve is in the upright position the water valve is open. When winterizing or storing for long periods it is recommended to close the bypass valve by turning the valve a quarter turn; see [Winterizing and Storage](#) on page 9-12.



**⚠ WARNING**  
Review the water heater literature supplied in your owner's packet before proceeding.











**⚠ CAUTION**  
This appliance does not have a pilot. It is equipped with an ignition device which automatically lights the burner. Do not try to light the burner by hand.

**NOTICE**  
The water heater has built-in FREEZE PROTECTION and will intermittently cycle the burner when the water temperature is between 1°C/ 35°F to 4.5°C/40°F. To provide this freeze protection, the gas supply must be on, gas must be available and electrical power must be on.

### Control Center

The water heater is controlled by the Control Center located on the wall above the bathroom sink.



| DISPLAY DESCRIPTION   |  |   |
|---|--|---|
|    | BURNERS  |    |
|    | FLAME  | This icon is displayed when FLAME is established.   |
|    | BLOWER   | This icon is displayed when the BLOWER is running   |
|    | TURN OFF WATER HEATER                                  | This icon is displayed when the Water Heater is OFF.  |
|    | SETTING TEMP INDICATOR;<br>OUTLET WATER TEMP INDICATOR | A. When setting the water temperature, the temperature display will flash. After SET Temperature is reached, the display stops flashing after a few seconds.<br>B. When the demand for hot water has been terminated, the display will return to the SET Temperature. |
| BUTTON DESCRIPTION  |  |   |
|  | ON/OFF   | Power Button. Switch from turning unit ON or turning unit OFF.  |
|  | SWITCH   | Hold for 5 seconds to switch between degrees (°) Celsius or degrees (°) Fahrenheit  |
|  | UP   | INCREASE SET Temperature by 1 degree increments. Setting range is 35°C/95°F to 55°C/130°F   |
|  | DOWN   | DECREASE SET Temperature by 1 degree increments. Setting range is 35°C/95°F to 55°C/130°F   |



# AIRSTREAM®

## Section 6 EXTERIOR

|  |     |  |      |
|--|-----|--|------|
| EXTERIOR CARE . . . . .                                | 6-2 | EXTERIOR DOORS . . . . .               | 6-9  |
| WAXES AND POLISHES . . . . .                           | 6-2 | Entry Door. . . . .                    | 6-9  |
| HOW TO CARE FOR YOUR TOURING<br>COACH FINISH . . . . . | 6-2 | Screen Door . . . . .                  | 6-9  |
| Washing Your Touring Coach . . . . .                   | 6-3 | Utility Compartment Doors . . . . .    | 6-9  |
| Wheel Care and Cleaning. . . . .                       | 6-3 | Tail Lights . . . . .                  | 6-9  |
| ROADSIDE EXTERIOR COMPONENTS . . . . .                 | 6-4 | AWNING . . . . .                       | 6-10 |
| CURBSIDE EXTERIOR COMPONENTS . . . . .                 | 6-5 | Awning Use In Wind and Rain . . . . .  | 6-10 |
| EXTERIOR FEATURES . . . . .                            | 6-6 | Awning Manual Override . . . . .       | 6-10 |
| Body Kit. . . . .                                      | 6-6 | Awning Care and Maintenance. . . . .   | 6-11 |
| Windows . . . . .                                      | 6-6 | HYDRAULIC LEVELING SYSTEM . . . . .    | 6-11 |
| Exterior Shower . . . . .                              | 6-6 | Leveling . . . . .                     | 6-11 |
| City Water Hookup . . . . .                            | 6-7 | HITCH COVER . . . . .                  | 6-12 |
| Exterior Folding Step . . . . .                        | 6-7 | How To Remove The Hitch Cover. . . . . | 6-12 |
| Lock Extended Switch . . . . .                         | 6-7 |  |      |
| Receptacle, Cable, and USB Ports . . . . .             | 6-8 |  |      |
| Shoreline Power Inlet and Cordset . . . . .            | 6-8 |  |      |
| SmartPlug Inlet . . . . .                              | 6-8 |  |      |
| SmartPlug Cordset. . . . .                             | 6-8 |  |      |

## Exterior Care

The Exterior cab and chassis portion of your Atlas Touring Coach has been painted by Sprinter. The Airstream up-fitted and body kit portions have been sent out by Airstream to be painted. Care of Sprinter's paint is detailed in their manual. The following additional information is provided by Airstream to help you understand the finish and its care. Following these instructions will provide a long lasting, high-gloss finish for your recreational vehicle. These same procedures can also be applied to your everyday automobile, producing the same long-lasting results.

### NOTICE

**Information on finish care may provide additional information and tips on the use of the Sprinter Van as a touring coach, however, no information about the exterior finish of your touring coach in this manual should be interpreted as advice or directions to disregard or void the warnings, cautions, or other information contained in the Sprinter's manuals.**

## Waxes and Polishes

Over 90 percent of all automotive finishes are clear coat. The finish on your touring coach is a state-of-the-art Acrylic Urethane Basecoat/ClearCoat. This means you will wash and polish a clear urethane coating designed to protect the basecoat: the pigmented coating that provides color. As its main function is protecting the basecoat, the clearcoat needs to be maintained especially in harsh environments. Clearcoats do not fade themselves, but appear to fade or lose gloss as the surface becomes contaminated by the environment. If this contamination is not removed frequently, the result will be a dull or low-gloss finish. Occasional washing alone will not adequately remove some forms of contamination and polishing will be required.

Polishes and waxes primarily serve the following purposes:

1. To remove minor surface imperfections caused by water spots and acid rain
2. To remove minor scratches by filling them and leveling the surface
3. To beautify the paint finish appearances with more depth and high-gloss
4. To protect the paint finish from the elements

Do not use products that contain harsh abrasives such as rubbing or polishing compounds. These products should be used by experienced technicians with the proper training and equipment. Most polishes and waxes are designed to clean and polish in one application.

A hand-applied polish or wax will offer outstanding performance and protect the Atlas finish. When applying polish or wax, do so in a shaded area making sure the surface is at the specified temperature according to the polish manufacturer's recommendations. Due to the variations of polishes and waxes, incorporate the following suggestions into the polishing technique:

1. Condition the polishing pad by rubbing a slight amount of polish on it.
2. Use only the amount of polish specified in the label directions.
3. Work a small area at a time.
4. Rinse off and remove dried polish from crevices, trim, and moldings.
5. Follow the products manufacturer's directions.

## How to Care for Your Touring Coach Finish

Keeping your touring coach looking its best at all times involves keeping the paint finish clean and in good condition. This means periodic washing and polishing, as well as getting the paint finish repaired as soon as possible when the paint is damaged or affected in any way. The purpose of the paint finish is twofold:

- Provide an aesthetically pleasing appearance.
- Protect the vehicle from the environment.

Your touring coach is exposed to many environmental conditions that have an adverse effect on the paint finish:

1. Road salts and sodium chloride
2. Road tar/bugs
3. Bird droppings/tree sap
4. Industrial fallout/acid rain/pollution
5. Ultraviolet exposure and moisture

The most common problems resulting from these conditions are corrosion, staining, and chemical spotting. These problems can be minimized through regularly-scheduled washing and polishing.

## Washing Your Touring Coach

Make sure the touring coach's surface temperature is not too hot, under 90°F, and not in direct sunlight. A shady area is ideal for washing your vehicle, as direct sunlight causes water and soap to evaporate too fast, resulting in water spotting. Use a mild soap or detergent.

Most auto care stores carry a car wash shampoo. Try to avoid combination wash-n-wax products as these waxes cause buildup and are designed for smaller surfaces. Have two dedicated sponges or wax mitts: one for the paint finish and one for the wheels and under carriage. Brushes or wash mitts that have plastic bristles are acceptable for use on tires and wheel wells, but are not intended for use on the paint finish. Avoid using such items on painted surfaces, as they will damage the touring coach paint and finish.

Wash from the top and work your way down, frequently rinsing to minimize grit abrasion. Follow with a final rinse of water. This process will remove most contamination from the touring coach's surface. For stubborn stains such as road tar, use an ammonia-based glass cleaner or a small amount of rubbing alcohol on a damp cloth immediately followed by warm soapy water and rinse with clean water. This may not dissolve the road tar, but will loosen tar and bug stains and remove them from the surface. Do not use solvent-based cleaners on bird droppings or tree sap as these are water-based stains and will eventually dissolve using an ammonia-based glass cleaner, warm soapy water and a little "elbow grease." Once again, after removing stubborn stains immediately rinse with clean water.

Drying the touring coach is just as important as washing your vehicle as today's tap water and well water contain many chemicals that could water stain your touring coach's finish. We suggest using a damp natural or synthetic chamois, however, there are other drying products such as lint free micro-fiber towels that work just as well.

Follow these simple cautionary measures, and your new finish will give you maximum gloss and durability.

It is recommended that the caulking and sealant used in external seams and joints such as window frames, light bezels, beltline, and rub-rail molding, etc., be checked regularly. If this material has dried out and becomes cracked or checked, or if a portion has fallen out, it should be replaced with fresh material to prevent possible rain leaks. Caulking and sealing material is available from your touring coach dealer and most RV supply stores.

## Wheel Care and Cleaning

It is important to regularly clean the rims of your touring coach to prevent the buildup of debris, such as brake dust, chemicals, and salts. These materials can trap moisture against the finish surface, causing corrosion, pitting, and deterioration.

Follow the steps below to clean the rims with mild soap and warm water only:

1. Always allow the wheels to cool to ambient temperature before starting to clean. Even mild soaps can cause stains if applied at elevated temperatures.
2. Rinse the wheel before to washing.
3. Using only a soft clean cloth or soft brush to clean the wheels with soap and warm water.
4. After cleaning the surface, rinse thoroughly to remove all soap so it will not spot. Towel dry.

### NOTICE

**Never use any abrasive pads, coarse brushes, or harsh/abrasive chemical cleaners especially those offered by most automatic car wash operations. Wheels should be cleaned after each exposure to harmful chemicals/materials.**

### ⚠ CAUTION

**When using a power washer, maintain a proper distance from the touring coach. The proper distance is approximately 2.2 ft. when using a round jet nozzle, and 1 ft. when using a 25 degree flat spray jet nozzle. Never point the jet nozzle at moldings, hoses, electrical components, seals, plug connections, etc. Never use round jet nozzles on tires, the pulsating water can damage the sub-structure of tires.**

## Roadside Exterior Components

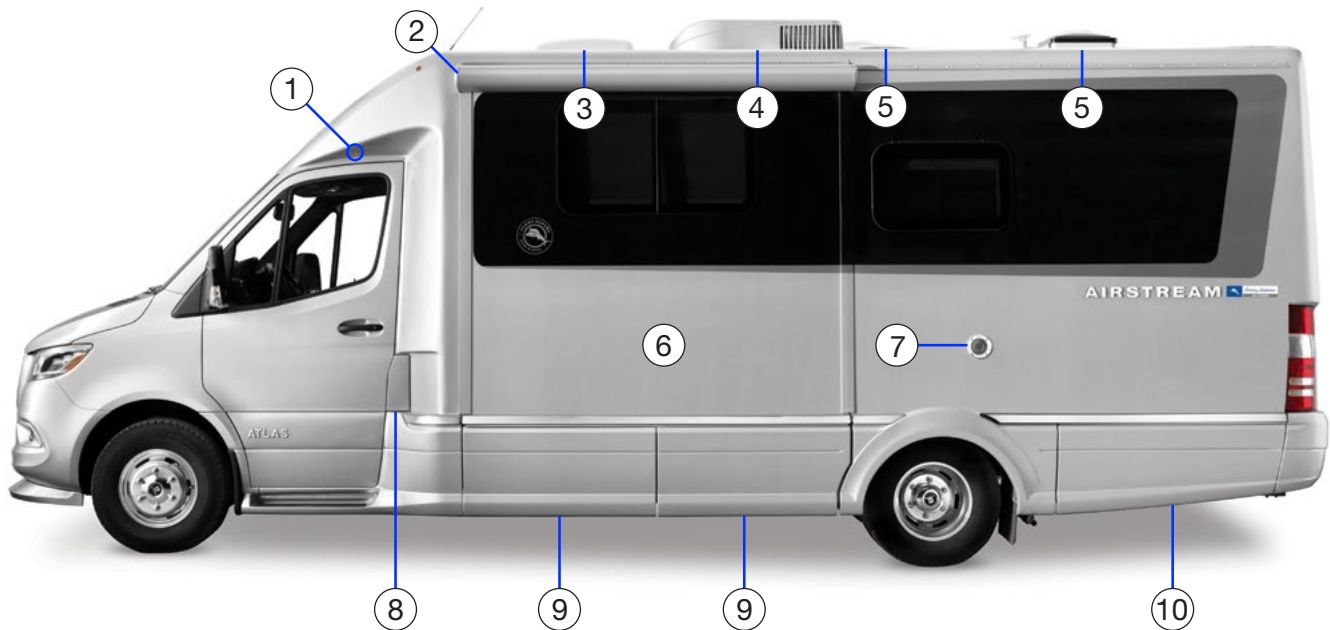

### NOTE

Sections 6 and 9 contain additional information about these components. Mid-production changes may affect the exact location of the features shown above.

1. Exterior door light. Comes on when the door is opened and shuts off when the door is closed.
2. Slide-out awning; extends and retracts with the slide out; [see Slide-Out Room on page 5-7](#).
3. Power skylight. Opens and closes via Multiplex System or the switch on the skylight; [see Multiplex System on page 5-20](#).
4. Rooftop air conditioner; [see Air Conditioner on page 5-24](#).
5. Ceiling vent fans; [see Ceiling Vent Fan on page 5-25](#).
6. Slide-out wall. Extended/retracted using the switch located in the cabinet at the entry door or by the main Multiplex control panel; [see Slide-Out Room on page 5-7](#).
7. Hot water tank exhaust vent. When operating, be sure exhaust can escape into a well ventilated area as vent can be hot; [see Water Heater on page 5-27](#).
8. Diesel fuel door. Driver's door needs to be opened to access; [see Utility Compartment Doors on page 6-9](#).
9. Weather sealed storage compartments; [see Utility Compartment Doors on page 6-9](#).
10. Exterior rear compartment contains:
  - City water hookup and tank fill. Use only clean, fresh potable water; [see City Water Hookup on page 6-7](#).
  - Exterior shower; [see Exterior Shower on page 6-6](#).
  - Switches for the dump valves, macerator pump, and macerator pump high-pressure hose reel; [see Drain and Waste System on page 9-10](#) and [see Emptying the Black and Gray Water Holding Tanks on page 9-11](#).
  - Black tank flush; [see Black Water Tank Flush on page 9-12](#).
  - LP tank remote fill and shutoff location; [see LPG Tank Remote Fill on page 9-6](#).
  - Cable/Pre-wired Satellite TV inlet; [see Antenna Pre-Wiring on page 5-22](#).
  - 30-amp power cord inlet. Power cord can be stored inside; [see Shoreline Power Inlet and Cordset on page 6-8](#).



## Curbside Exterior Components

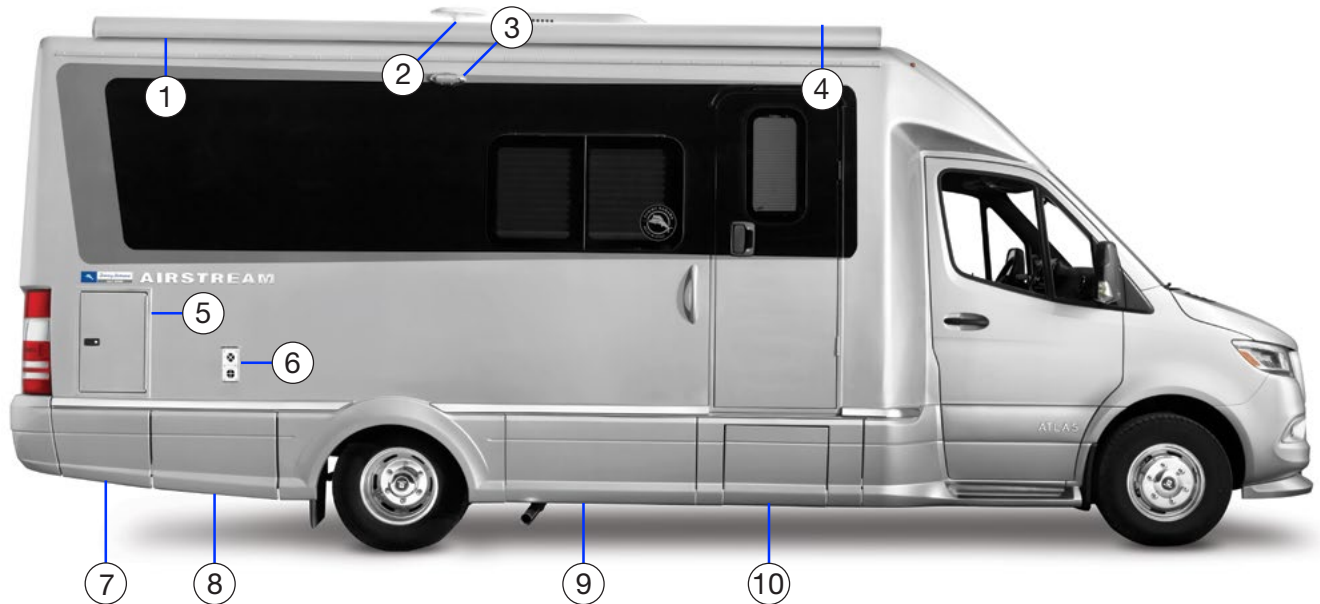

### NOTE

**Sections 6 and 9 contain additional information about these components. Mid-production changes may affect the exact location of the features shown above.**

1. Patio Awning. Controlled by the multiplex system; see [Awning](#) on page 6-10.
2. Power boosted omni-directional TV antenna. Antenna is wired into TV outlets on exterior of coach and inside the front overhead roof locker; see [TV/Radio Antenna](#) on page 5-22.
3. Patio Light; Multiplex System, on the lights screen; see [Multiplex System](#) on page 5-20.
4. Connected RV pre-wired antenna (blocked from view by awning in photo above). Provides access to the internet by creating a local area network. Router required (sold separately); see [Airstream Connected RV Antenna Pre-Wire](#) on page 5-23.
5. Large weather sealed compartment with key lock; see [Utility Compartment Doors](#) on page 6-9.
6. Furnace exhaust vent. When operating, be sure exhaust can escape into a well ventilated area as vent can be hot; see [Furnace](#) on page 5-26.
7. Weather sealed rear compartment; see [Utility Compartment Doors](#) on page 6-9.
8. Generator compartment. All switching is done automatically once the generator is started from the multiplex panel; see [Automatic Generator Start \(AGS\)](#) on page 5-17.
9. Exterior compartment, see [Utility Compartment Doors](#) on page 6-9; contains:
  - Exterior 120-volt outlet that provides an exterior GFCI protected electrical source; see [Receptacle, Cable, and USB Ports](#) on page 6-8.
  - TV outlet and HDMI port provides reception for an exterior television. It is pre-wired and integrated into the Cable/Satellite TV system; see [Receptacle, Cable, and USB Ports](#) on page 6-8.
10. Folding step with auto extend/retract, step out warning buzzer, and lock extended switch for easy entry into the touring coach; see [Exterior Folding Step](#) on page 6-7.

## Exterior Features

### Body Kit



The body kit provided by Airstream is made from state-of-the-art high impact plastic. The same material is used in the automotive industry for moldings, bumper guards, and trim. The kit is made to color specifications and requires no paint or finish. The cleaning procedures are the same as the painted finish on the Sprinter body; however, there are several automotive plastic care products on the market for exterior parts that will provide added protection from UV ray damage, dirt, and stains. Find one you like and use it as often as needed to help prevent fading.

### Windows

Clean your touring coach windows the same way you clean the windows in your home. Clean the seals with a damp cloth and mild detergent every 3 to 6 months. Do not use strong solvents, as they will damage the seals. A coat of natural silicone lubricant applied after the seal has dried will keep it flexible. Spread the lubricant evenly with a brush or finger, working it into the surface. This is a good practice for all rubber seals in your touring coach.

### **⚠ WARNING**

**Failure to properly clean and lubricate the window seals could result in the window sticking to the jamb and should only be released by a qualified technician trained in the procedure. Do not force, pry, or apply great pressure to open the window. Failure to heed this warning may cause the window to shatter and/or cause personal injury.**

For replacement of a damaged window, contact an Airstream Service Center.

### Exterior Shower



All units are equipped with an exterior shower. This shower consists of a shower hose, shower head, and water valve inside the lockable roadside rear utility compartment. Water is supplied by the pump or city water hookup. To use: thread the hose onto the wall inlet, verify it is securely connected. Press the spout button and rotate the faucet handles to the desired temperature. To remove hose assembly, unscrew the hose from the water valve. Be sure to press the spout button to relieve any residual pressure before removing the hose.

## City Water Hookup



The city water hookup is located in the roadside rear utility compartment of the touring coach. Your plumbing system has a built-in pressure regulator, limited to 50 psi, to protect your lines and faucets from extremely high pressures on some city water systems.

Use a tasteless, odorless, non-toxic, high-pressure hose of at least 1/2-in. diameter designed for motorhome use. The city water inlet is a standard garden hose thread. We suggest you carry two lengths of hose in order to reach hookups farther away than normal, as well as to have a spare.

After hooking up the hose, through the bottom access hatch inside the compartment, turn on the city water valve provided in the park and slowly open a faucet. There will be a lot of spurts and sputtering until all the air is expelled from the touring coach's system. It may take some time before all the air is expelled and a steady flow of water occurs. Once a steady flow is achieved at one faucet, the others should be opened long enough to expel the air in the lines going to them.

The water hookup is also used to fill the fresh water tank. To fill, turn ON the fresh water valve switch located below the shoreline power hookup. A red indicator light will turn on indicating the valve is open. When the switch is ON water is diverted to fill the fresh water tank. The valve will automatically close and the switch will turn OFF when the tank is full. If you wish to carry less than a full tank of water the fill percentage can be viewed on the main Multiplex control panels "Home" screen. Once the fill level reaches your desired percentage switch OFF the fresh water valve switch to close the valve.

## Exterior Folding Step

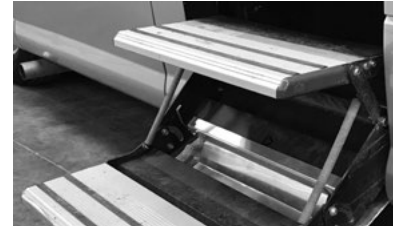

The curbside door has a folding double step with auto retract, step out warning buzzer, and a lock extended switch located just inside the door. Please read, understand, and instruct passengers of the following operational and safety information pertaining to the step.

The steps extend and retract as the door is opened and closed with the engine off and step lock extend switch off. The steps retract automatically and will not extend when the engine is started to prevent damage while in transit.

If the steps do not retract fully, a warning buzzer will sound. The vehicle should not be driven if the steps fail to retract completely.

### **Lock Extended Switch**

To use the lock extended switch, turn the engine off, open the door to extend the steps, and turn the switch on. The steps will now remain extended while opening and closing the door. Turn the switch off to return the steps to normal operating mode.

If you forget to turn the lock extended switch off before starting the engine, the steps will retract when the engine is started, however, they will not extend when the engine is turned off and the door is opened. To reset the steps, turn the engine off and the step lock extended switch off with the door closed.

### **⚠ WARNING**

**LOOK BEFORE YOU LEAP.** The steps will not extend with the opening of the door when the engine is running. Check that the steps are extended before leaving and entering the vehicle. Failure to follow this warning could result in personal injury.

## Receptacle, Cable, and USB Ports



An exterior receptacle is located in the curbside utility compartment between the wheels and step. Also in this compartment is the exterior cable hook-up, HDMI inlet, and USB ports. A motion sensor light has been installed for your convenience. The light can be manually switched off if needed, however, if switched off the motion sensor will not function.

## Shoreline Power Inlet and Cordset



### SmartPlug Inlet

Your Airstream is equipped with a SmartPlug power inlet located inside the exterior roadside rear compartment. Prior to establishing a connection, review the SmartPlug Cordset instructions that follow.

Features of the SmartPlug include:

- Eliminates Overheating - Increased pin & clip surface area improves conductivity during high demand.
- Ease of Use - The unique plug body shape and push-in design ensure a proper connection.
- Multi-Point Locking System - Side clips lock the plug securely into the inlet, eliminating stress on the pins.
- Weatherproof Seals - Multi-fin silicone gaskets installed in the inlet cover and interior of the plug body eliminate moisture penetration.

### SmartPlug Cordset

Before connecting power to your Airstream, plug the cordset (power cord) into the power pedestal and check the cordset's safe/unsafe LED indicator lights. If the red LED illuminates, do not plug the cordset into the SmartPlug inlet on your Airstream.

The cordset has a Reverse Polarity Indicator System with two LED indicator lights, one blue and one red. Reverse polarity occurs when connecting a cordset to a power pedestal that has the positive and negative leads reversed internally. A reverse polarity condition is unsafe, and it can damage an Airstream's electrical components.

Safe/Unsafe LED Signals:

- Blue ON, Red OFF - Normal Power, Safe
- Blue ON, Red ON - L1 and neutral are swapped in a reverse polarity condition, Unsafe
- Blue OFF, Red ON - L1 and ground are swapped in a dangerous reverse polarity condition, Unsafe
- Blue OFF, Red OFF - No Power

Many campgrounds provide less than 30 amp service, and your hookup may blow their fuse or circuit breaker. If this happens, reduce the load, replace the fuse, or reset the breaker.

## **⚠ WARNING**

**A reverse polarity condition is detected if the cordset's LED illuminates RED when connected to a power source. If this occurs, do not plug the cord into your Airstream. Reverse polarity is an UNSAFE condition that could result in bodily harm. It can also damage electrical components. This condition exists when the power pedestal is improperly wired.**

## Exterior Doors

### Entry Door

The side entry door is manufactured with a built-in, keyed dead bolt and door lock. The door lock, located below the door handle, is engaged from the inside by a red lever. The dead bolt, located above the door handle, is engaged by rotating the black knob. The door lock can be locked or unlocked using the key fob. The side door will only lock using the key fob if it is closed. To unlock using the key fob quickly double press the unlock button.

For lubrication and out-of-adjustment issues, see [Section 9](#).

#### **⚠ WARNING**

**Before driving, the main entry door lock and dead bolt must both fully locked. If the door is not fully locked, the constant vibration of travel may cause the door to vibrate open.**

### Screen Door

The screen door is secured to the threshold of the main door and can be operated independently by sliding and latching it via a magnet catch. This innovated door takes a fresh approach to maximizing fresh air and your view while offering a smooth and steady screen operation.

#### **NOTICE**

**Check that the screen door is retracted before closing the exterior door. Failure to follow this caution could result in damage to the screen door.**

### Utility Compartment Doors

The Atlas Touring Coach has several hidden utility hatches incorporated into the lower trim on each side of the coach. The compartment doors have no visible latches and are locked/unlocked using the key fob.

The utility compartment doors will lock when the lock button on the key fob is pressed or when the touring coach is in motion.

To unlock the utility doors quickly press the unlock button on the key fob twice. This will unlock the cab doors as well as the utility doors.

#### **NOTE**

**To unlock the utility compartment doors at least one cab door must be closed. If both driver and passenger doors are opened the key fob will not unlock the utility doors.**

#### **⚠ CAUTION**

**Alarms have been incorporated to warn of an open exterior compartment when ignition is started. If an alarm sounds check the main Multiplex control panel for a warning notification before proceeding.**

### Tail Lights

Atlas Touring Coach tail lights are hinged and can be opened to access for service. The tail light is held close by a magnet. To open, reach under the bottom edge of the tail light and pull.

#### *Opened*



#### *Closed*



## Awning

 The awning manufacturer's manual can be found in your Airstream owner's packet or by scanning this QR code and navigating to the instructions on Carefree's website at <https://www.carefreeofcolorado.com/>.

Extend and retract the awning and control the awning lights using the Multiplex panel.

Depending on when your Airstream was built, the awning may have a preinstalled Bluetooth® module that allows you to control awning functions using the Carefree Connects™ app. For instructions on downloading and using the app, and Bluetooth® pairing, scan the QR code above and navigate to the Carefree Connects information page.



### NOTE

**If extended, the awning will automatically retract when the vehicle is taken out of "Park". When the vehicle is in motion the awning will lock, preventing it from being extended while traveling. The lockout will be reset and the awning can be extended again after the engine has been turned off.**

## Awning Use In Wind and Rain

The automatic extra strong awning comes with a Direct Response™ System wind sensor. The Direct Response™ System is an innovative wind sensor system that automatically activates the 12V motor and retracts the awning in strong winds, thus avoiding possible damage to the awning. The awnings primary use is for sun protection, it is recommended the awning be retracted in case of rain, wind, or snow.

### NOTICE

**If wind or extended periods of rain are expected, retract the awning and secure as for travel. The effects of wind and rain on any awning are unpredictable. Severe damage to the vehicle and or the awning may result and cannot be covered by warranty.**

## Awning Manual Override

If power to the vehicle is not available, the awning can be safely retracted using the manual override located on the idler (right) end of the case. A ratchet and socket extension has been included and is located under the passenger side compartment floor.

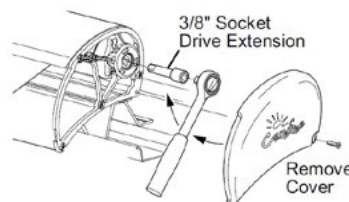

1. Remove the cover from the right end cap and save.
2. Insert the 3/8" socket drive extension and handle into the square drive hole inside the end cap.
3. Turn the handle clockwise until the awning is retracted.
4. Replace the end cap.

**⚠ CAUTION**

**After closing the awning with the manual override, the lead rail may move out from the case 1/4"-1/2". This is normal and the awning is secure for travel until power is restored or repairs are completed. Do NOT attempt to force the lead rail in with the override, serious damage can occur to the awning.**

**NOTE**

**Manual override cannot be used to extend the awning.**

**Awning Care and Maintenance**

1. PERIODIC MAINTENANCE: Like any other part of the touring coach, an owner should periodically inspect the awning. The following items should be checked.
  - a. All mounting brackets are tight.
  - b. Check all pivot points for enlargements of holes or broken rivets.
  - c. Check end caps for cracking and splitting.
  - d. Check that awning rail is tight against coach and all screws are tight.
  - e. Check canopy for loose stitching and possible shrinkage or puckering.
  - f. Clean and lubricate all tension knobs and pivot points.

Fuse Location: Chassis fuse panel under driver’s seat.

**Hydraulic Leveling System**

Your Airstream has an electrically/hydraulically driven leveling system. The hydraulic pump is powered by a 12 volt direct current motor, which pumps hydraulic oil through the hydraulic hoses to four leveling jacks. The leveling system can be operated by the control panel on the passenger’s seat pedestal under the skirting. The control panel can be removed and used remotely within 10 feet of the touring coach. The four leveling jacks are mounted directly to the touring coach’s chassis and are pre-set to the required leveling capacity.

**Leveling**

Before starting the leveling procedure you must follow these guidelines:

1. Park on a surface that is as level as possible.
2. The parking brake must be engaged.
3. The transmission must be in Park.
4. The vehicles ignition must be ON.

To start the automatic leveling process press the “ON/OFF” button, located on the control panel, to switch the system ON. Press the “Automatic Mode” button to begin the leveling procedure. Once the leveling process is complete press the “ON/OFF” button again to turn the leveling system OFF. The jacks can be retracted by turning ON the system and pressing the “Retract All Jacks” button once. Make sure to turn OFF the leveling system once the jacks are in their stowed position.

For more information on the hydraulic leveling system, or how to manually level the touring coach, please refer to the user manual provided in your owner’s packet.

**NOTICE**

**Depending on the terrain the automatic leveling process takes about one minute during which all persons should refrain from entering the vehicle.**

**⚠ WARNING**

**This product is exclusively developed as a leveling system and may not be used for other work under the vehicle such as changing the tires or maintenance.**

**⚠ WARNING**

**All jacks will retract when the parking brake is released or the ignition is turned on.**

## Hitch Cover

### How To Remove The Hitch Cover

#### *Before Removal*



#### *After Removal*



1. Kneel down behind the rear bumper. There are two black wing nuts on each corner of the cover shown below.



2. Rotate each wing nut 1/4 turn, pull down and remove.

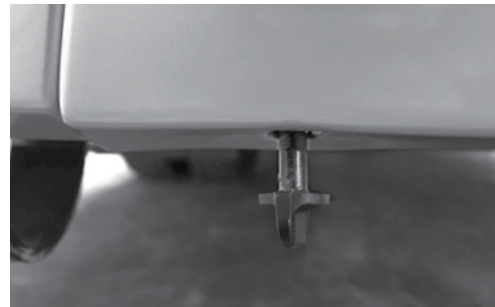

3. Pull straight down to remove the cover. Once removed you can store this in one of the utility compartments. Reverse these instructions to reinstall.



# AIRSTREAM®

## Section 7 SPRINTER VAN

|   |     |   |      |
|---|-----|---|------|
| IMPORTANT SPRINTER INFORMATION . . . . .  | 7-2 | CHANGING A TIRE . . . . .                       | 7-6  |
| Fuels and Operating Fluids . . . . .  | 7-2 | Flat Tire . . . . .                             | 7-6  |
| Travel Warning Light . . . . .  | 7-2 | Precautions When Changing a Wheel . . . . .     | 7-6  |
| Mercedes me Connect App . . . . .   | 7-2 | Procedure . . . . .                             | 7-7  |
| Component Identification . . . . .  | 7-2 | Jack . . . . .                                  | 7-7  |
| Sprinter Van - Serviced by Mercedes-Benz<br>Sprinter or Its Suppliers . . . . .                               | 7-3 | INSTALLING AND REMOVING A WHEEL . . . . .       | 7-8  |
| Chassis . . . . .   | 7-3 | Mounting a New Wheel . . . . .                  | 7-8  |
| Driver's and Passenger's Seats and<br>Restraint Systems . . . . .   | 7-3 | Centering Wheels With Wheel Fasteners . . . . . | 7-8  |
| Airstream Components - Serviced by<br>Airstream Authorized Service Centers or<br>Airstream suppliers. . . . . | 7-3 | Lowering the Vehicle . . . . .                  | 7-8  |
| Cab Area . . . . .  | 7-3 | Wheel Bolt/Lug Nut Tightening . . . . .         | 7-8  |
| Living Quarters . . . . .   | 7-3 | TIRE ROTATION . . . . .                         | 7-9  |
| Electrical Components . . . . .   | 7-3 | Rotation Pattern for Dual Rear Wheels . . . . . | 7-9  |
| Exterior . . . . .  | 7-3 | Support . . . . .                               | 7-9  |
| TIRES . . . . .   | 7-4 | Correct . . . . .                               | 7-9  |
| Vehicle Placard and Tire Inflation Pressure<br>Label . . . . .  | 7-4 | Incorrect . . . . .                             | 7-9  |
| Proper Tire Inflation . . . . .   | 7-4 | AIR RIDE SUSPENSION . . . . .                   | 7-10 |
| Under Inflation . . . . .   | 7-4 | Manual Adjustments . . . . .                    | 7-10 |
| How Overloading Affects Your Tires . . . . .  | 7-5 |   |      |
| Tires and Wheels . . . . .  | 7-5 |   |      |
| Tire Grip . . . . .   | 7-5 |   |      |
| Hydroplaning . . . . .  | 7-5 |   |      |

# Sprinter Van

The Airstream Atlas Touring Coach is integrated into a Sprinter Van designed and manufactured by Mercedes-Benz. Operation of the Sprinter, its engine, power train, and other related components are discussed in the Mercedes-Benz Sprinter Owner's Manual and other literature provided by Sprinter. As a point of reference, those systems discussed in this literature are warranted by Mercedes-Benz or their suppliers.

## Important Sprinter Information

Your Mercedes-Benz Sprinter Van Operator's and Warranty Manuals contain important Cautions, Warnings, operational, and warranty information on the Sprinter and its components. All information in the Sprinter manual should be reviewed and followed for your safety. The Airstream Owner's Manual may provide additional information and tips on the use of the Sprinter Van as a touring coach; however, no information in the Airstream manual should be interpreted as advice or directions to disregard or void the warnings, cautions, or other information contained in the Sprinter manuals. If you believe there is a conflict in information, Warnings, Cautions, or safety-related information between the Sprinter and Airstream manuals, please contact the Airstream customer relations department immediately to resolve the conflict.

## Fuels and Operating Fluids

The Sprinter Operator's Manual contains important information about the fuel and operating fluids approved for use by Mercedes-Benz. Review the Sprinter manual's information and notes on maintenance, fuel grades, and Mercedes-Benz-approved operating fluids before refueling or servicing the vehicle.

Refill only with commercially available ULTRA-LOW SULFUR DIESEL (ULSD, maximum sulfur content 15 ppm). Mercedes-Benz recommends fuels with a bio-diesel content of 5% (B5) or less whenever possible. The use of B20 fuel requires special precautions addressed in your Sprinter manual.



### NOTICE

**Do NOT use R95 diesel fuel. Use only fuels and operating fluids approved by Mercedes-Benz. Do NOT use any fuel additives or other operating fluid additives. Using the wrong fuel, incorrect operating fluids, or both may damage the vehicle.**

## Travel Warning Light

The travel warning light on the dash indicates that there is an open compartment or component which will make driving unsafe. Warnings include open Exterior Compartment, Awning, Skylight, extended Hydraulic Leveling Jacks or Step. See multiplex monitor panel if travel light is illuminated for displayed warning message.

## Mercedes me Connect App

 Access your vehicle from anywhere and experience all the benefits of ownership with  Mercedes me connect. To learn more, scan this QR code or visit <https://www.mbvans.com/en/connectivity>.



The Mercedes me connect App directly pairs with your vehicle. Download the app from the link above (by scanning the QR code), or click on one of the following icons:



The app will guide you through the activation process, but you may also reach out to your Mercedes-Benz dealer to activate your account. For additional assistance, please call the Mercedes-Benz Customer Assistance Center at 877-762-8267.

## Component Identification

If repairs are needed, it may be difficult to determine which parts are Mercedes-Benz and which are Airstream's responsibility. The lists on the following page show the major components of the van and the company responsible for their servicing.

 For assistance in locating a Mercedes-Benz service center in the United States, scan this  QR code or visit <https://www.mbvans.com/en/vehicles/dealer-locator-pages/dealers> and use the Mercedes-Benz dealer locator, or call 877-762-8267.

See Mercedes-Benz Sprinter Warranty Information Manual for complete instructions.

## Sprinter Van - Serviced by Mercedes-Benz Sprinter or Its Suppliers

### Chassis

|                                   |                                 |
|-----------------------------------|---------------------------------|
| Engine                            | Speed control                   |
| Exterior automotive lights        | Automotive electrical system    |
| Engine battery                    | Instrument panel cluster        |
| Power mirrors                     | Hitch receiver and tow plug     |
| Engine cooling system             | Cab doors                       |
| Fog lamps                         | Heated drivers/passenger seats  |
| Transmission                      | Cab door windows and windshield |
| Chassis suspension                | AM/FM radio antenna             |
| Brakes                            | Dash Multimedia Center          |
| Drive axle and hubs               | Dash AC/heater/defroster        |
| Steering assembly, Steering wheel | Cargo door assist handle        |
| Heated windshield                 | Lane keeper assist              |
| Automotive fuse panel             | Blind spot assist               |
| Wheels, Tires                     | High beam assist                |
| Parking brake                     | Collision prevention assist     |
| Alternator                        | Parktronics                     |
| Fuel pump                         |                                 |

### Driver's and Passenger's Seats and Restraint Systems

Sprinter provides the swivel pedestals and Airstream provides the seat decorative skirting and recovers the front seats to match the surrounding decor.

### Airstream Components - Serviced by Airstream Authorized Service Centers or Airstream suppliers.

#### Cab Area

- Driver's and passenger's seat skirting and covers.
- Floor Mats
- Dash Kit
- Rear View Mirror/Monitor
- Exterior door lights

### Living Quarters

- Fire extinguisher
- Interior furniture
- Appliances in the lounge/lavatory area.
- Smoke/CO/LP detectors
- Three piece sun and privacy shade
- Window Coverings
- Floor covering
- All plumbing systems

### Electrical Components

- Monitor panel and its system
- Inverter/Charger
- House batteries
- Battery disconnect
- Power vents
- 120-volt system
- 12-volt living area system
- Multiplex System
- Living area entertainment center
- Roof AC
- TV antenna
- GPS/Sirius antenna
- TVs

### Exterior

- Alcoa Dura Bright Rims
- Exterior body kit
- Power step
- Exterior lights
- Awning
- Air Ride System
- Generator
- Macerator pump
- Soar panels

**NOTE**

Some features listed may not be available on your Atlas.

**NOTICE**

Please contact Airstream or Onan for a service location if repairs are need for the generator.

If you need further clarification or information, contact the Airstream Customer Relations Department at (937) 596-6111 before contacting a service center for an appointment.

If you wish to write, the address is:

Airstream Inc.  
 Attn: Customer Service  
 428 W. Pike Street  
 P.O. Box 629  
 Jackson Center, Ohio 45334

## Tires

Under inflation or over inflation of tires is dangerous. Under inflation can result in tire flexing, heat build-up, tire overloading, bad handling, bad fuel economy, and uneven wear. Over inflation can result in abnormal wear, bad handling, and harsh ride.

Tire inflation pressures should be checked as per the Mercedes-Benz Sprinter Owner's manual and when significantly changing the load you plan to carry in your touring coach. Set the correct tire pressure before loading the vehicle. Always check tire inflation pressures when the tires are "cold." See section 4 for tire specifications. Front and rear pressures and GVWR are shown for each model, and are based on the GVWR and front and rear axle ratings (GAWRs) printed on your vehicle VIN plate and certification label. Tires must be inflated to these pressures when the vehicle is fully loaded or an axle GAWR is reached.

For tire sizes and inflation pressures, [see Specifications on page 4-3](#).

Proper front end alignment improves tire tread mileage. Your front-end suspension parts should be inspected periodically and aligned when needed. Improper alignment may or may not cause the vehicle to vibrate. However, improper toe alignment will cause front tires to roll at an angle, which will result in faster tire wear. Incorrect caster or camber alignment will cause your front tires to wear unevenly and can cause the vehicle to "pull" to the left or right.

### Vehicle Placard and Tire Inflation Pressure Label

The TIRE AND LOADING INFORMATION placard supplies information on the size and the cold tire inflation pressure for the original equipment tires supplied with your vehicle. Check the Sprinter manual for all weights and tire information placard location.

A MOTORHOME TIRE SAFETY ADDENDUM is included with your Airstream owner's packet. Please take the time to read, understand, and follow the information contained in the booklet.

### Proper Tire Inflation

The level of air in your tires affects your vehicle's overall performance. Not even the highest quality tire will perform well if it's not inflated properly. The correct pressure varies from vehicle to vehicle and depends in part upon driver preference. Each vehicle has a recommended inflation pressure, usually found on a placard. Check the Sprinter manual for all weights and tire information and the placard location.

Correct tire inflation is a key component in tire care. The recommended inflation pressures for your tires are indicated on the certification label or in your owner's manual. Since touring coach's can be loaded with many different configurations, the load on each tire will vary. For this reason, air pressure should be checked based on the load on each individual tire. Cold Inflation Pressure should be adjusted to handle the maximum tire load, and all tires on the axle should carry the same inflation pressure. Cold tire inflation pressure is the tire pressure checked in the morning before you drive more than a few miles or before rising ambient temperatures or the sun's radiant heat affect it. Check your tire air pressure at least once a month, before each trip, and each morning you drive during a trip. Tire pressure should be checked cold, as tire pressure ratings have been designed with typical running heat/pressure build up in mind. Make sure the valves and caps are free of dirt and moisture.

### Under Inflation

Under inflation brings a higher risk of susceptibility to damage due to road hazards, reduces tire casing durability, and causes a loss in fuel economy, plus uneven or irregular tire wear. Severe under inflation brings about an increased risk of tread separation, handling difficulties, and possibly tire failure, which is caused by overheating.

## **⚠ WARNING**

**It is a common practice for motorhome owners to lower tire pressure in their search for a smoother ride. This is not only dangerous, it is relatively ineffective, and the difference in ride quality is not significant. When minimum inflation pressure requirements are not met, tire durability and optimum operating conditions are compromised. Tire inflation pressure should always meet at least the minimum guidelines for vehicle weight.**

- It may be necessary to inflate your tires at a truck stop or truck service center in order to achieve adequate air pressure for your coach's needs
- Only permanent air seal metal valve caps should be used.
- Be safe - if a tire has been run 20 percent under inflated, it must be dismantled and inspected by a trained professional. It should not be inflated without a full inspection or without using a safety cage. Use a calibrated gauge. If your tire is rated for higher inflation pressures, a special gauge designed for larger tires will be required.

## **⚠ WARNING**

**Due to RISK OF EXPLOSION damaged tires or tires run with more than a 20% underinflation (approximate) must be dismantled, inspected by a trained professional, and should not be inflated without using a safety cage.**

- Don't bleed air from warm tires to reduce pressure buildup.
- Don't inflate tires to cold psi rating beyond rim specifications.

### **How Overloading Affects Your Tires**

Tire pressure is what enables your touring coach tires to support loads. Overloading your tires can have serious consequences for passengers and your touring coach. Too much weight can cause stress on your touring coach's suspension system, brake failure, shock absorber damage, handling and steering problems, irregular tire wear and possible tire failure. Excessive loads or under inflation can lead to an excessive amount of heat and tire failure. If you discover that your tires cannot handle the load, lighten the weight of the load on your tires.

### **Tires and Wheels**

(This section is partially excerpted from the Mercedes-Benz Sprinter Van Operator's Manual.)

Check tires regularly for even tread wear, tread depth (note legal requirements), and signs of external damage. Use only wheels and tires of the same size, make, and pattern.

Do not install tires that are not approved for the size and type of wheel installed on the vehicle itself. Only use those wheel sizes that were delivered to you by your authorized Mercedes-Benz Sprinter dealer.

Use only wheels and tires that have been tested and approved by the vehicle manufacturer.

Break in the tires at moderate speeds for distance of about 65 miles.

## **⚠ WARNING**

**Always replace wheel nuts that are damaged or rusted. Never apply oil or grease to wheel nuts. Damaged wheel hub threads should be repaired immediately. Incorrect mounting bolts or improperly tightened mounting bolts can cause the wheel to come off. This could cause an accident. Make sure to use the correct mounting bolts. Check tightness of wheel nuts regularly and retighten if necessary.**

### **Tire Grip**

Tire grip is greatly reduced on a wet or icy road. Speed and driving style must therefore be adapted to suit road conditions. Below a tread depth of 1/8 in., tire grip begins to decrease rapidly on wet roads.

### **Hydroplaning**

Depending on the depth of the water layer on the road, hydroplaning may occur, even at low speeds and with new tires. Reduce vehicle speed, avoid grooves in the road, and apply brakes cautiously in the rain.

The majority of flood-related deaths are caused by people attempting to drive through moving water. Driving into flood waters may be the most dangerous thing one might ever try. Considering the following:

- Most cars will float (and be swept away) in 18-24 inches of moving water. Trucks and SUVs have only 6-12 more inches of clearance. Creeks and rivers can rise very rapidly and the road bottom can also wash away, making the water much deeper than it appears.
- Once cars are swept downstream, they will often roll to one side or perhaps flip over entirely. The driver has a few seconds to escape the vehicle. Many drivers panic as soon as the vehicle submerges and are found later with their seat belt intact.

## Changing A Tire

(Partially excerpted from the Mercedes-Benz Sprinter Van Operator's Manual)

After changing a wheel, the wheel nuts must be tightened once the vehicle has been driven for about 30 miles.

If new or repainted wheels are fitted, the wheel nuts must be retighten again after about 600 to 3000 miles. Do not use remolded tires.

### **⚠ WARNING**

Fitting wheel sizes other than those supplied by Sprinter to the vehicle will change the Sprinter's handling characteristics and may lead to an accident resulting in severe personal injuries, death and property damage.

### **⚠ WARNING**

Read the Sprinter manual for wheel bolt or lug nut torque and wheel tightening procedures.

### **⚠ WARNING**

The Mercedes-Benz Sprinter Operator's Manual contains important cautions, warnings, specifications, and operational information on changing, maintaining, and replacing of the tires and wheels. Read, understand, and follow the Sprinter manual sections for changing a tire.

### **⚠ CAUTION**

Changing a tire on a touring coach chassis is a physically demanding procedure. It requires specialized tools and knowledge of safety procedures. Only you can determine your knowledge base and physical ability. Don't take any unnecessary risks. Find a safe area to park your unit, and call a tire service center and supply them with the information in the Sprinter Manual if you have any doubts about changing a tire.

## Flat Tire

If you get a flat tire while driving, gradually decrease your speed. Hold the steering wheel firmly and slowly move to a safe place on the side of the road. The pressure of the spare wheel (sold separately) should be checked regularly (at least after every tenth time at the filling station).

The vehicle tool kit is located in a hatch under the front passenger foot well.

### **⚠ WARNING**

Use a jack (sold separately) designed exclusively for jacking up the vehicle at the jack take-up brackets built into either side of the vehicle. To help avoid personal injury, use a jack only to lift the vehicle during a wheel change. Never get beneath the vehicle while it is supported by a jack.

## Precautions When Changing a Wheel

- Keep hands and feet away from the area under the lifted vehicle.
- Always firmly set parking brake and block wheels before raising vehicle with jack.
- Do not disengage parking brake while vehicle is raised.
- Always use the jack on a level surface.
- Do not jack the vehicle up more than 1-2 in. between the tire and the surface. Otherwise, the vehicle may tip over and may cause serious injury or death to you or others.
- Be sure that the jack arm is fully seated in the jack take-up bracket.
- Always lower the vehicle onto sufficient capacity jack stands before working under the vehicle.
- Do not damage, grease, or oil wheel nuts or stud threads.

## Procedure

- Park the vehicle on a firm, level, non-slippery surface.
- Switch on the hazard warning flasher switch, apply the parking brake, and place the transmission selector in "P".
- Everyone must leave the vehicle before you jack it up.
- Everyone must leave the danger zone before you jack up the vehicle. Danger zones vary with locations. Take a minute and look at what might happen if the vehicle falls off the jack and rolls. Set up your danger zone.
- The vehicle must be safeguarded in accordance with legal regulations (such as using a warning triangle).
- Prevent vehicle from rolling away by blocking wheels with wheel chocks (not supplied with vehicle) or sizable woodblocks or stone. On a level road place one chock in front of and one behind the wheel that is diagonally opposite to the wheel being changed. When changing a wheel on mild uphill or downhill grade, place chocks on the downhill side blocking both wheels of the other axle. Do not jack vehicle up on a steep grade.

### **⚠ WARNING**

**Do not change wheels on a steep uphill or downhill grade. The vehicle may begin to move and fall from the jack, which could cause property damage, personal injury, and/or death.**

## Jack

Read, understand, and follow the Mercedes-Benz Sprinter Operator's manual instructions, cautions, and warnings for changing a wheel and jack point locations.

- Loosen the wheel nuts before raising the vehicle.
- Close the release valve on the jack.
- Assemble the pump lever provided and insert it into the socket on the jack.
- Secure lever by turning it clockwise in the socket.
- Position the jack under the appropriate jack point and raise the vehicle by pumping the lever.

### **⚠ WARNING**

**A jack (sold separately) is intended only for raising the vehicle briefly, for instance when changing a wheel. The jack must be placed on a firm, flat surface only. Do not crawl under the vehicle while it is raised with a jack. Do not start the engine while the vehicle is jacked up. Do not jack the vehicle up more than 1-2 in. between the tire and the surface. The vehicle may tip over and cause serious injury or death to you or others. Jack stands must always be used while working beneath the vehicle. Failure to follow these precautions could result in property damage, personal injury, and/or death.**

## Installing and Removing A Wheel

- Loosen the wheel fasteners (wheel bolts or lug nuts).
- Jack up the vehicle until the wheel is clear of the ground.
- Unscrew the fasteners and remove the wheel (keep the fasteners clean).

### **⚠ WARNING**

If the vehicle moves forward or backward while it is being jacked up, lower it, stabilize the vehicle, and repositioned the jack. When the vehicle is jacked up, the jack must stand vertically (plumb-line).

### Mounting a New Wheel

- Before fitting the spare wheel, clean rust and dirt off the contact surfaces of the wheel and the wheel hub and from wheel bolts or lug nuts.
- Note the specified wheel and tire size, tire load capacity, and speed code.
- Do not change the tire's direction of rotation.
- Do not damage, grease, or oil wheel bolts or lug nuts or their threads.

### Centering Wheels With Wheel Fasteners

- If dual assemblies are used, before placement, the inner wheel should be inspected to ensure all ball bearing rings are in the proper position.
- Install the wheel and snug the wheel fasteners.
- Slightly tighten wheel fasteners.

### Lowering the Vehicle

- Slowly open the jack release valve to lower the vehicle until tire is resting on the ground.
- Tighten the wheel fasteners in a crisscross pattern, as specified, with a torque wrench. For wheel fastener torque procedures, see the Mercedes-Benz Sprinter Van Operator's Manual.
- Remove the jack and stow.
- Check the tire pressure. For tire pressures see the vehicle manufacturing tag on the driver's door jam of your touring coach; also [see Specifications on page 4-3](#).
- Torque wheel fasteners immediately after reinstalling a wheel and again after 30 miles.

### **⚠ WARNING**

Only certain tires meeting the tire size/load/speed index ratings contained in the Tire Pressure Tables, found in the Index Section of the Mercedes-Benz Sprinter's Operators or Owner's Manual, are certified to conform to FMVSS 120 for the Sprinter Vehicle. Please check the sidewalls of your originally-equipped tires for specific makes/sizes, and speed load ratings when you need to replace your tires. To prevent accident, injury, or possible death, use only the correct tires for your tire replacement.

### Wheel Bolt/Lug Nut Tightening

Torque wheel fasteners evenly to specification with a torque wrench using a crisscross pattern in the proper sequence:

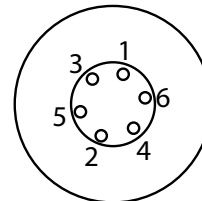

### **⚠ WARNING**

Consult the Mercedes-Benz Sprinter Operator's manual for extensive wheel installation, tightening, torque procedures, cautions, and warnings.

### **⚠ WARNING**

Wheel fastener torque must be checked immediately after reinstalling a wheel and again after 30 miles. Torque all wheel fasteners evenly to specification using the proper sequence. For torque values, [see Specifications on page 4-3](#).

### **⚠ WARNING**

Tightening by hand or with an impact wrench can result in loose or overtightened wheel fasteners, which could lead to a wheel falling off while driving or damage wheel and brake components.



## Tire Rotation

Front and rear tires perform different jobs and can wear differently depending on the types of roads driven, driving habits, etc. To obtain the longest tire life, you should inspect and rotate your tires regularly.

Many automotive dealers and tire dealers will perform a free tire inspection to look for uneven or abnormal tire wear.

Tires should be rotated every 6,000 to 8,000 miles. For the longest tire life, any time irregular wear is seen have the tires checked, alignment checked, and tires rotated by your truck or tire dealer. Have the cause of uneven wear corrected.

### Rotation Pattern for Dual Rear Wheels.

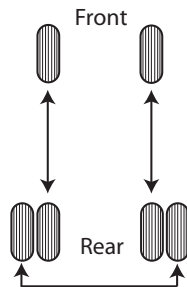

### **⚠ WARNING**

Read the Mercedes-Benz Sprinter Operator's Manual for complete instruction on tire rotation, installation, and maintenance.

### **NOTICE**

Vehicles with aluminum alloy wheels will require tires to be dismounted and remounted so as to leave rims in original locations because the dura bright finish is only applied to one side.

### Support

Since touring coach's may sit for long periods it is important to properly support the tires if blocks are used for leveling.

Extreme caution must be taken to ensure that the tires are fully supported when using blocks to level the touring coach. The load on the tire should be evenly distributed on the block and in the case of duals, evenly distributed on blocks for both tires. If not done, the steel cables in the sidewall of the tires may be damaged and could lead to premature fatigue of the sidewall.

### Correct

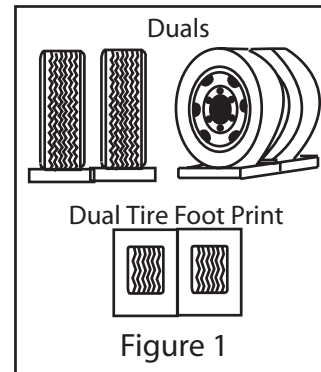

The CORRECT methods are shown in Figure 1. Dual tires are supporting the full load. Please note that the blocks are wider than the tread and longer than the tire's footprint. This provides maximum support to the tires and ensures that the load is evenly distributed throughout the tire's footprint area.

### Incorrect

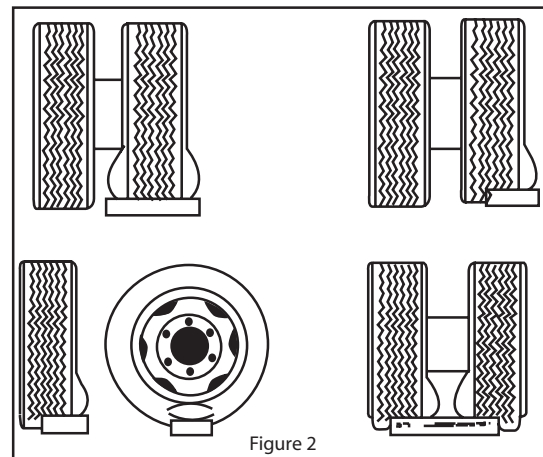

INCORRECT methods are shown in Figure 2: One tire, a portion of one tire, or portions of two tires are supporting the full load.

### **⚠ WARNING**

Tires that are incorrectly supported may be damaged, which could lead to casing failure resulting in serious injury or property damage. If, on previous occasions, the tires have been incorrectly supported, hidden damage may be present. Please contact your local tire dealer and request an inspection and a determination of possible damage.

# Sprinter Van

---

## Air Ride Suspension

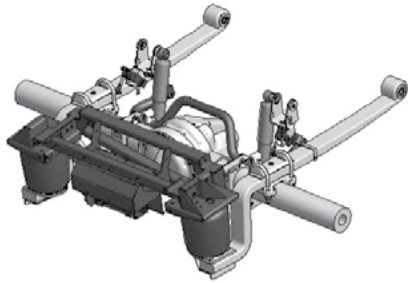

The touring coach is equipped with a rear axle air suspension. The Mercedes-Benz Sprinter Van is extremely suited for this air suspension system.

The full-air rear-axle air-suspension, has an electronic system which automatically monitors and adjusts the height level of the vehicle. This constant monitoring and adjusting will automatically contribute to safer vehicle behavior and better comfort.

The Atlas air ride system has a “ferry ramp” option allowing the touring coach to be driven at max height up to 7 mph, after which the coach will return to its normal ride height.

### **⚠ CAUTION**

**Carefully read and understand all manufacturer’s instructions provided in your owner’s packet prior to operating.**

## Manual Adjustments



A remote, located on the B-pillar next to the drivers seat, can be used to manually adjust the air suspension. To manually adjust, while parked set the emergency brake. With the engine running, press the up or down arrows to raise or lower the rear of the van.

### **NOTE**

**Once the vehicle is in motion, the air ride system will automatically self-adjust to ride height. You can not manually adjust the height while the vehicle is in motion.**

# AIRSTREAM®

## Section 8 DRIVING

|  |     |   |      |
|--|-----|---|------|
| LOADING . . . . .  | 8-2 | TOWING A TRAILER . . . . .                              | 8-6  |
| Weighing . . . . .   | 8-2 | Towing a Boat . . . . .                                 | 8-6  |
| Vehicle and Trailer Weights and<br>Ratings Definitions . . . . . | 8-2 | Tracking . . . . .                                      | 8-6  |
| Procedure for Weighing a Touring Coach . . . . .                 | 8-3 | Brake Controller . . . . .                              | 8-7  |
| Weight Distribution . . . . .                                    | 8-3 | Backing Up . . . . .                                    | 8-8  |
| SAFETY . . . . .   | 8-4 | Rearview and Side Monitor System . . . . .              | 8-9  |
| Seat belts . . . . .   | 8-4 | Passing . . . . .                                       | 8-9  |
| TRAILER TOWING AND DRIVING TIPS . . . . .                        | 8-4 | Parking Your Touring Coach . . . . .                    | 8-9  |
| Hitch . . . . .  | 8-4 | TOWING YOUR TOURING COACH . . . . .                     | 8-9  |
| Loading a Trailer . . . . .                                      | 8-5 | SAFETY CHECK LIST . . . . .                             | 8-10 |
| Checking Weights of Vehicle and Trailer . . . . .                | 8-5 | Exterior Check List (Before Entering Vehicle) . . . . . | 8-10 |
| Attaching a Trailer . . . . .                                    | 8-5 | Interior Check List (Before Driving) . . . . .          | 8-10 |

## Loading

One of the most critical aspects of safely operating a touring coach is knowing the weight involved and where it is placed. The first thing to determine is how much cargo is being loaded and confirming that it is within the capacity of the equipment being used. Determining WHERE that load is placed is critical to the way your rig will handle on the road.

Do not try to guess what your touring coach weighs loaded. Load your touring coach including water, propane, etc and take it to a public scale. Weigh each axle of your vehicle. Refer to your axle weight and tire limits to see if you are within a safe range. Total all axle weights and make sure you are below the GVWR. If you are not overloaded, make sure your load is balanced. Do not load too much on one side. A balanced load is much easier to tow or drive.

Front to back balance is also important. Step back and look at your touring coach. Make sure there is not too much weight in the front or on the rear of the touring coach. Be sure to secure all items. Loose items can cause damage and can be a safety issue.

The Cargo Carrying capacity tag shown below is installed on every touring coach and can be found on the inside of the door on your vehicle.

MOTOR HOME OCCUPANT AND CARGO CARRYING CAPACITY  
VIN \*\*\*\*\*  
THE COMBINED WEIGHT OF OCCUPANTS AND CARGO SHOULD NEVER EXCEED  
XXX kg or XXX lbs  
Safety belt seating capacity:XXX  
CAUTION  
A full load of water equals XXX kg or XXX lbs of cargo @ 1 kg/L (8.3 lb/gal) and the tongue weight of a towed trailer counts as cargo

To arrive at “THE COMBINED WEIGHT OF OCCUPANTS AND CARGO SHOULD NEVER EXCEED” number, Airstream weighs the vehicle as finished and adds the weight of full tanks of LP and chassis fuel. That number is subtracted from the GVWR of the touring coach and listed on the tag, The total weight of any and all cargo, including but not limited to dealer or customer modifications or additions, fluids (fresh water and holding tanks), food, clothes, tools, tongue weight of a towed trailer or vehicle, and passengers should never exceed the number listed while the touring coach is in transit.

The “SAFETY BELT SEATING CAPACITY” is the number of passengers that seat belts are provided for.

The “A FULL LOAD OF WATER EQUALS” number is arrived at by multiplying the fresh water tank and water heater capacities by 1Kg/L or 8.34 lb/gal.

When loading the vehicle it is important to keep the GVWR, GAWR, Tire Weight Ratings (listed on the vehicle tire Information placard), and the cargo and occupant capacity in mind and not to exceed these specifications. Your safety depends on not overloading the touring coach, axles, and tires. For more information, [see Specifications on page 4-3](#).

## Weighing

To determine the actual weight of your vehicle with personal cargo and water, it must be weighed on scales as you plan to travel. The most common scales are those used by states to weigh trucks along the highway. In rural areas, grain elevators, gravel pits, and cement outlets are a good source.

### NOTE

**Weighing instructions for this touring coach are explained on the next page. If you have trouble locating scales, a call to your State Highway Patrol will usually find them cooperative in assisting you.**

## Vehicle and Trailer Weights and Ratings Definitions

Gross Vehicle Weight Rating (GVWR) is the maximum permissible weight of the touring coach.

Gross Vehicle Weight (GVW) comprises weight of vehicle including tools, installed accessories, passengers, cargo, and trailer tongue weight. It must never exceed the GVWR.

Gross Axle Weight Rating (GAWR) is the maximum permissible axle weight.

Gross Trailer Weight (GTW) is the maximum permissible trailer weight to be towed.

Trailer Tongue Weight Rating (TWR) is the maximum permissible weight of the trailer tongue. This counts as cargo when loading a touring coach.

### NOTE

**Check the Sprinter manual for all weights and the tire information placard location.**

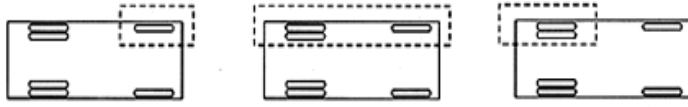
|  |   |   |  |
|--|---|---|--|
| Front Axle GAWR  | GVWR  | Rear Axle GAWR                                      | GCWR - GVW   |
| SCALE WEIGHT   |   | Optional Tow Weight                                 |  |
|  |   |   |  |
| STEP 1<br>Front Axle GAW   | STEP 2<br>GVW   | STEP 3<br>Rear Axle GAW                             | STEP 3a<br>Tow Weight minus<br>Weight of Trailer<br>or Vehicle Towed |
| INDIVIDUAL WHEEL POSITION WEIGHT   |   |   |  |
|   |   |   |  |
| STEP 4<br>Left Front Wheel<br>Position   | STEP 5<br>Left Side<br>(Total LF + LR)                | STEP 6<br>Left Rear Wheel<br>Position               |  |
| Calculated   | Calculated  | Calculated  |  |
| Right Front Wheel<br>Position<br>Step 1 minus Step 4                               | Right Front<br>(Total RF + RR)<br>Step 2 minus Step 5 | Right Rear<br>Wheel Position<br>Step 3 minus Step 6 |  |

GAWR = Gross Axle Weight Rating  
 GVWR = Gross Vehicle Weight Rating  
 GCWR = Gross Combination Weight Rating

### Procedure for Weighing a Touring Coach

Vehicle should be weighed loaded, as you normally travel.

1. Fill in first row from Specification Section; see [Specifications on page 4-3](#).
2. Weigh vehicle as shown in row 2 (Scale Weight) and fill in blanks.
3. Weigh one side of vehicle as shown in Individual Wheel Position Weight.
4. Calculate other side as shown in last row.

### NOTE

**Check the Sprinter manual for all weights and the tire information placard location.**

### Weight Distribution

Touring coach's have fresh water and gray water tanks, a water heater, and storage areas. It gives you great flexibility in loading. If you want to load down all the storage compartments, the amount of fluids may have to be reduced. Distribute your additional cargo as evenly as possible with the heaviest objects located as low as possible.

Consider waiting until you are near or reach your destination to fill the fresh water tank. Even if you're going to a remote area, you can usually fill your water tank shortly before entering the area. Just reducing your load by 10 gallons of water lets you carry an additional 83.4 lbs. of cargo.

## Safety

### Seat belts

Federally approved seat belts are provided for the use of the driver, passenger, and the lounge sofa. Most states require by law that all passengers in a motor vehicle use seat belts while in transit. It is strongly recommended that all occupants remain seated with their safety belts firmly attached while the touring coach is in transit. The driver should adjust his or her seat so that he or she is able to reach all controls easily with the belt on, and be able to use all the travel on the foot brake. Seat belts should be placed as low as possible around the hips to prevent sliding out from under them in case of an accident. This places the load of the body on the strong hipbone structure instead of around the soft abdominal area. Remember, there should only be one occupant per seat belt when traveling.

The driver and front passenger seat belt buckle operation is explained in the Sprinter manual.

The lounge sofa seat belt buckles are secured by inserting the male end into the female buckle until the buckles are secured. To release the buckle press the release button on the female end.

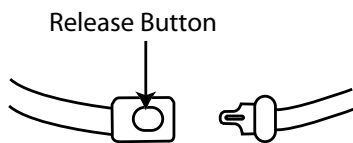

### **⚠ WARNING**

**Become familiar with and follow all directions, advice, and warnings pertaining to seats, seat belt operation, and restraint systems, provided in the Mercedes-Benz Sprinter Operator's Manual. Do not allow passengers to ride anywhere in the touring coach except in seats that are equipped with approved seat belts.**

### **⚠ DANGER**

**Children must be secured in a federally-approved child restraint device. Failure to use proper restraints while in transit can result in severe or fatal injuries. Never place an infant seat that faces to the rear on the front passenger seat. Never place an unbelted infant seat on any seat while in transit.**

Child restraint devices are designed to be secured with lap or lap/shoulder belts. All instructions supplied by the restraint manufacturer must be followed. Statistics have shown children are safer when properly restrained in a rear seating position than in a front seating position.

Don't hesitate when it comes to passenger safety. Make sure all passengers are properly restrained.

## Trailer Towing and Driving Tips

(Some text is partially excerpted from Mercedes-Benz Sprinter Operators Manual.)

### **⚠ WARNING**

**Failure to use proper equipment and driving technique can result in a loss of vehicle control when towing a trailer. Improper towing or failure to follow the instructions contained in this section can result in serious injury. Follow the guidelines below carefully to assure safe trailer operation. Ask your authorized Mercedes-Benz Sprinter or Airstream dealer if you require an explanation of information contained in the manuals.**

### Hitch

Atlas units have hitches and wiring installed from the Mercedes-Benz manufacturer. The Sprinter 7-way connector is used for lights and charge line on a trailer. For further information, please see your authorized Mercedes-Benz Sprinter dealer.

To reduce the possibility of damage, remove the hitch ball adapter from the receiver when not in use.

Since this vehicle is designed and intended primarily as a load-carrying vehicle, towing a trailer will affect handling, durability and economy. Maximum safety and satisfaction depends upon proper use of correct equipment and avoiding overloads and other abusive operation.

### **⚠ WARNING**

**The total weight of the touring coach and trailer must not exceed the GCWR listed in the specification section of this manual. The maximum towing capacity varies according to the size of the touring coach and its GCWR. Vehicles should be properly equipped for towing trailers. Information on trailer hauling capabilities and special equipment required may be obtained from your Mercedes-Benz Sprinter and/or Airstream dealer.**

### Loading a Trailer

When loading a trailer, you should ensure neither the permissible GTW (Gross Tongue Weight), nor the trailer GVWR are exceeded.

Maximum permissible values are listed on the safety compliance certification labels for the vehicle and for the trailer to be towed. For their location, see the Mercedes-Benz Sprinter Operator's Manual. The lowest value listed must be selected when determining how the vehicle and trailer are loaded.

To assist in attaining good handling of the vehicle/trailer combination, it is important that the tongue weight be maintained at approximately 10-15 percent of the loaded trailer weight, but not to exceed the hitch rating. Tongue loads can be adjusted by proper distribution of the load in the trailer, and can be checked by weighing separately the loaded trailer and then the tongue.

The tongue weight at the hitch ball must be added to the GVW to prevent exceeding your Sprinter towed vehicle's rear GAWR.

When towing trailers, touring coach tires should be inflated to the highest pressures shown on the Sprinter Tire Information Placard. See Mercedes-Benz Sprinter Operator's Manual for its location. The Cargo Carrying Capacity (CCC) of this vehicle is reduced by the amount that equals the trailer tongue load on the trailer hitch.

### Checking Weights of Vehicle and Trailer

To assure that the tow vehicle and trailer comply with the maximum permissible weight limits and to know the actual weights, have the loaded vehicle-trailer combination (tow vehicle including driver, passengers, cargo and trailer fully loaded) weighed on a commercial scale as explained earlier in this section.

Also, check the vehicles front and rear axle weights and tongue weight. The values as measured must not exceed the Sprinter weight ratings listed on vehicle information placards and in the Mercedes-Benz Sprinter manual. These ratings are also listed in the Specification section of this manual, [see Specifications on page 4-3](#).

#### NOTE

**Check the Mercedes-Benz Sprinter manual for all weights and tire information placard locations.**

### Attaching a Trailer

Please observe maximum permitted trailer dimensions (weight and length).

Most states and all Canadian provinces require safety chains between your tow vehicle and trailer. The chains should be crisscrossed under the trailer tongue. They must be attached to the hitch receiver and not to the vehicles bumper or axle. Be sure to leave enough slack in the chains to permit turning corners.

Most states and all Canadian provinces required a separate brake system for towing trailers.

#### **⚠ WARNING**

**The towing vehicle's braking system is rated for operation at GVWR, NOT at the GCWR. A separate, functioning brake system is required for any towed vehicles or trailers weighing more than 1000 lb (450 kg) when fully loaded. NEVER exceed the GVWR, or the GAWR specified on a touring coach certification label. Also, NEVER exceed the weight ratings of a trailer hitch installed on a touring coach. Failure to heed any part of this warning could result in loss of control of the touring coach and towed vehicle or trailer which may cause an accident and serious injury. For specified towed vehicle braking requirements, consult the Mercedes-Benz Sprinter Operator's Manual that comes with the vehicle.**

#### **⚠ WARNING**

**Do not connect a trailer brake system (if trailer is so equipped) directly to the vehicle's hydraulic brake system if your vehicle is equipped with anti-lock brakes. If you do, neither the vehicle's brakes nor the trailer's brakes will function properly. Property damage, injury, or death to you or others may be the result.**

The provided vehicle electrical wiring harness for trailer towing has a brake signal wire for hookup to a brake controller. Most states and all Canadian provinces require a breakaway switch on trailers with a separate brake system. The switch activates the trailer brakes in the possible event that the trailer might separate from the tow vehicle. Please consider using a trailer sway control system. For further information, see your authorized Mercedes-Benz Sprinter or Airstream dealer.

## Towing a Trailer

There are many different laws, including speed limit restrictions, having to do with trailer towing. Make sure that your vehicle-trailer combination will be legal not only for where you reside, but also for where you'll be driving. A good source for this information can be the State Attorney General, State Police, or local authorities.

Before you start driving with a trailer, check the trailer's hitch, breakaway switch, safety chains, electrical connections, lighting, and tires. Also, adjust the mirrors to permit an unobstructed view beyond the rear of the trailer.

If the trailer has brakes using an electric brake controller, start your vehicle and trailer moving slowly, and then apply the brakes manually using the brake controller to be sure the brakes are working properly. Read and follow the controller manufacturer's recommendations.

When towing a trailer, check occasionally to be sure the load is secure, and lighting and trailer brakes (if so equipped) are functioning properly. Always secure items in the trailer to prevent load shifts while driving.

Take into consideration that when towing a trailer, the handling characteristics are different and less stable from those when operating the vehicle without a trailer. It is important to avoid sudden maneuvers.

The vehicle and trailer combination is heavier, and therefore is limited in acceleration ability and requires longer stopping distances. It is more prone to reacting to side wind gusts, and requires more sensitive steering input.

In order to gain skill and an understanding of the vehicle's behavior, you should practice turning, stopping and backing up in an area which is free from traffic.

If possible, do not brake abruptly, but rather engage the brake slightly at first to permit trailer to activate its brake. Then increase the braking force.

We want every owner to be a safe and courteous driver. A few hours of towing practice in a large empty parking lot will make pulling your trailer over the road much easier. Line out two corners for left and right turns. You may also use these corners to practice backing and parking.

## Towing a Boat

While it is possible to tow a boat with your touring coach, Airstream does not recommend it. If you plan to pull and launch a boat, use caution when backing down boat ramps, and do not submerge any part of your touring coach in water. The slope of some boat ramps may be lower than others, requiring a portion of the tow vehicle to be submerged when launching. While this may be okay for some vehicles, your touring coach has sensitive electronics that water infiltration would irreparably damage.

### NOTICE

**It is imperative that you do not allow any part of your touring coach to be submerged in water as it could cause damage to electronics that a warranty would not cover.**

## Tracking

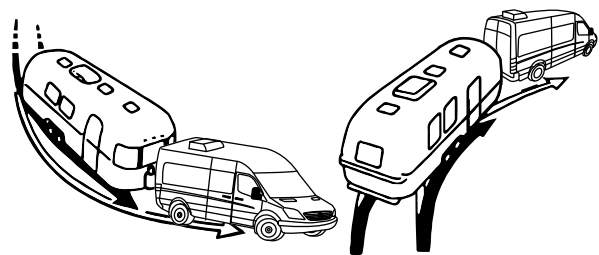

During practice, observe that the tracks made by the trailer wheels are distinctly different from those made by the tow vehicle. Studying this will make it easier for you to correct mistakes. Consider truck- or trailer-type fender or door grip rear view mirrors for maximum visibility. In most states, the law requires them.

After thoroughly inspecting your hitch, brakes, and tires, you should be ready to tow. Check traffic, signal that you are about to pull away, and start slowly. Look often in your mirrors, observe the action of the trailer, and then carefully move into the proper lane of traffic. Remember that the trailer wheels will not follow the path of the tow vehicle wheels; therefore, wider turns are necessary when turning to the left or right.

On freeways or expressways, try to pick the lane you want and stay in it. Always maintain plenty of space between you and the car ahead, at least the length of the tow vehicle plus trailer for every 10 mph. Remember that in order to pass another vehicle, you will need longer to accelerate. You must also allow for the length of the trailer when returning to the right hand lane. On a two-lane road cars may be lining up behind



you because you are traveling at a lower speed. It is both courteous and sensible to signal and pull over at the earliest safe opportunity and let them pass.

### **⚠ WARNING**

**Take into consideration that when towing a trailer, the handling characteristics are different and less stable from those with operating the vehicle without a trailer. It is important to avoid sudden maneuvers. Sudden maneuvers may lead to loss of control over the vehicle-trailer combination.**

### **Brake Controller**

The brake controller (if so equipped) is activated when you apply the brakes of the tow vehicle. Your tow vehicle brakes will automatically apply the trailer brakes first when properly adjusted. This will help keep your tow vehicle and trailer in a straight line and make you stop as if you were driving the tow vehicle alone. If swaying or swerving should occur, briefly operating the controller separate from the vehicle brakes may help correct the situation. Practice this maneuver on a clear highway. Do not wait for an emergency and then grope for the controller.

When towing a trailer, you might encounter a temporary cooling system overload during severe conditions such as hot days when pulling on a long uphill grade, when slowing down after higher speed driving, or driving long idle periods in traffic jams. If the hot indicator light comes on, or the temperature gauge indicates overheating and you have your AC turned on, turn it off. Pull over in a safe place and put on your emergency brake. Don't turn off the engine. Increase the engine idle speed. Lift the engine hood and check for fluid leaks at the radiator overflow outlet. Check to see that all drive belts are intact and the fan is turning. If you have a problem have it fixed at the next opportunity. If there is no problem the light should go off or temperature should come down within one minute. Proceed on the highway a little slower. Ten minutes later resume normal driving.

### **NOTICE**

**If the transmission continually shifts between gears on inclines, manually shift to a lower gear. A lower gear and reduction of speed reduces the chances of engine overloading and/or overheating. When going down a long hill, shift into a lower gear and use the engine's braking effect. Avoid riding the brakes, thus overheating the vehicle and trailer brakes. If the engine coolant rises to an extremely high temperature (e.g. coolant temperature needle approaching the red zone) when the AC is on, turn off the AC. Engine coolant heat can be additionally vented by opening the windows, switching the climate control fan speed to high and setting the temperature control to the maximum hot position.**

### **⚠ WARNING**

**Never open a radiator cap when the tow vehicle is hot. Add coolant when the vehicle is cool.**

### **⚠ WARNING**

**On slippery pavement, do not use engine drag to help slow down as this may cause the rear wheels of the tow vehicle to skid. On icy pavement, drive slowly and if you feel the tow vehicle skidding, gently apply the trailer brakes only. This will bring the tow vehicle and trailer back into a single line. Chains do not help trailer wheels.**

When going downhill in dry weather, downshift so that engine compression will slow the whole rig down. Take dips and depressions in the road slowly and do not resume normal driving speeds until you are sure that the trailer wheels are clear of the dip.

When driving in mud and sand, let the momentum carry the rig through. Apply power gently and use as little as possible. Stay in the tracks of the vehicle ahead and keep the tow vehicle in the highest possible gear. If you are stuck, it is best to tow out the entire rig together without unhitching.

Despite even the best hitch, you will notice that whenever a large bus or truck overtakes your rig the displaced air first pushes the trailer rear slightly to the right and then affects the front. It may be necessary to steer very slightly, momentarily, toward the bus or truck to help compensate for the sway induced by the passing-vehicle. Do not apply the vehicle brakes, as this can tend to exaggerate the situation. You may find, however, that briefly applying the trailer brakes with your manual control will help eliminate sway.

## **⚠ WARNING**

**CHOCK THE TRAILER WHEELS** when stopping on a hill or slope. Leaving your tow vehicle in gear is not enough for standstill safety. Do not use trailer brakes as parking brakes.

## **Backing Up**

In BACKING UP the important thing to remember is to DO EVERYTHING SLOWLY and to correct immediately if you see the trailer turning the wrong way. Concentrate on the rear of the trailer. With your tow vehicle and trailer in a straight line, back up slowly and turn the bottom of the steering wheel in the direction you want the trailer to go. Watch from the window or in the mirror until the rear of the trailer is pointing in the desired direction. Your tow vehicle will be following the trailer in an arc. Straighten the tow vehicle and trailer by turning the steering wheel more sharply, and then when they are in line, straighten the steering wheel.

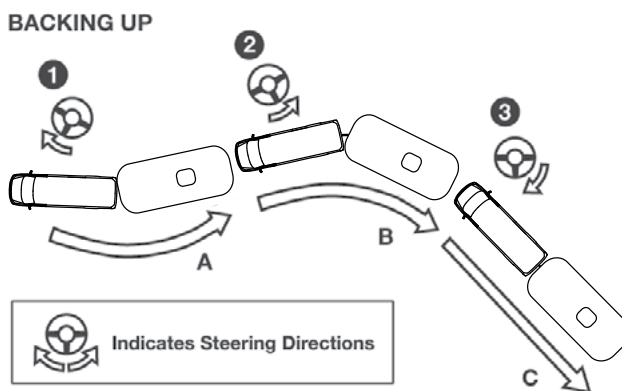

Start in position (A) start. Turning steering wheel as shown in (1). will put you in trailer position (B). Turning steering wheel show in position (2) puts you in trailer position (C). Steering position (3) returns front wheels to straight backing.

## **NOTICE**

**Always try to back to your left because the visibility is much better.**

When you do not make it on the first try it is usually much easier to pull forward to your original straight position and start over.

If your spouse or traveling companion normally directs you when backing they should position themselves forward of the tow vehicle so the driver can easily see them. Their directions should always indicate to the driver the direction the rear of the trailer should go. A little practice in a parking lot with the person giving directions can save a lot of frustration when backing into a campsite.

## Rearview and Side Monitor System

An LCD digital monitor comes standard and replaces the existing rear view mirror. It comes with a built-in speaker and touch screen buttons to control all settings.

Included in the system are side cameras which are displayed on the digital monitor. Side cameras are activated with the turn signals. Putting on your right turn signal will display the passenger side camera and your left signal will display the drivers side camera. Putting the vehicle in reverse will activate the back-up camera. The rear camera is the primary, and will override the side cameras if the vehicle is placed in reverse. The rear camera can be turned on while driving for use as a rearview mirror by pressing the power button.

### **⚠ CAUTION**

**Carefully read and understand all manufacturer's instructions provided in your owner's packet prior to operating.**

## Passing

Extreme care must be exercised when passing another vehicle. A vehicle with a trailer attached will require additional passing distance than when driving without a trailer. Because your vehicle and trailer is longer than your vehicle alone, you will also need to go much further ahead of the passed vehicle before you can return to your lane.

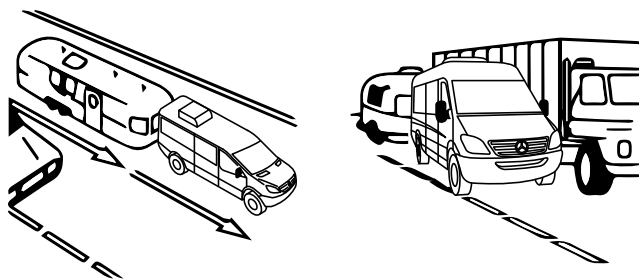

## Parking Your Touring Coach

To reduce the risk of personal injury or damage to the vehicle power train as a result of vehicle/trailer movement, always:

- Keep right foot on the brake pedal.
- Shift gear selector lever to position "N".
- Have a second person place wheel chocks on downhill side of left and right trailer wheels.
- Slowly release brake pedal allowing vehicle and trailer to roll into chocks until stopped.
- Using the manual parking brake beside the driver's seat. Lift the brake lever slightly while pressing the button, then press the lever to the floor.
- Move gear selector lever to position "P".
- On inclines, turn wheels toward the road curb.

## Towing Your Touring Coach

See the Mercedes-Benz Sprinter Operators Manual for towing information.

### **⚠ WARNING**

**Considerable damage may occur if the touring coach is improperly lifted for towing purposes. Only qualified professional towing service companies with proper equipment should be used. Observe all cautions and warnings in the Mercedes-Benz Sprinter Operator's Manual before towing your touring coach.**

## Safety Check List

Your Airstream Touring Coach should be given a thorough safety check before a trip. Regular use of the following list will provide safe operation of your touring coach and will help you spot any malfunctioning equipment and correct the problem as soon as possible. The list is to help you and may not be all-inclusive.

### **⚠ WARNING**

**Failure to heed the following items may cause damage to the vehicle or personal injury.**

#### Exterior Check List (Before Entering Vehicle)

1. Check condition of tires and keep tires at recommended inflation pressure per the tire and loading placard on the driver's door B-pillar.
2. Turn off remote LPG valve switch.
3. Check that macerator hose, city water hookup, TV cable/satellite, power cord, and all exterior components are unhooked and properly stowed.
4. Check that all external compartment doors are properly closed, latched and locked.
5. Check that items stored on exterior of vehicle are securely tied down.
6. Verify if any items stored on exterior of vehicle would present a clearance problem.
7. Follow all automotive manufacturer's recommendations on checking and filling fluid levels.
8. Check exterior lights and general condition of vehicle.

#### Interior Check List (Before Driving)

1. It is important that all doors be completely closed and locked during travel.
2. Turn off the water pump and close all faucets.
3. Check that refrigerator door is closed and latched if equipped.
4. Check that nothing heavy is stored in overhead or high cabinets, which could fall out and cause injury. Heavy items should be stored in lower cabinets.
5. Stow galley slide shelf and pedestal tables.
6. Check that counter tops, range top, and shelves are clear of even small items that could become projectiles during an emergency braking or accident.
7. Latch the shower doors.
8. Do not cook unless the touring coach is parked and stable. Hot food or liquid could scald due to a sudden stop or accident while traveling.
9. Be sure all LPG controls on the appliances are turned off.
10. Check that any internal stowage is securely held in place
11. Check that lights and switches are set in positions safe for travel.
12. Adjust the driver's seat so that you can easily reach and operate all controls. Make sure seat is locked in position. Do not adjust driver's seat swivel or recline mechanisms while vehicle is moving. The seat could move unexpectedly causing loss of control.
13. Check that all passengers have seat belts on properly.
14. The freedom of movement of the brake and accelerator pedals must not be impaired in any way.
15. Check rear view mirrors adjustment, inside and outside. Adjust window coverings if necessary for maximum visibility.
16. Secure children in a federally-approved child restraint device.

# AIRSTREAM®

## Section 9 MAINTENANCE

|   |      |  |      |
|---|------|--|------|
| MAINTENANCE SCHEDULE . . . . .                              | 9-2  | WINTERIZING AND STORAGE . . . . .                        | 9-12 |
| SUGGESTED MAINTENANCE AND<br>REPLACEMENT PARTS. . . . .     | 9-3  | Touring Coach Winterization . . . . .                    | 9-12 |
| Exterior Care. . . . .                                      | 9-4  | Component Locations for Winterization . . . . .          | 9-13 |
| TIRE CARE . . . . .   | 9-5  | Instructions for Winterization . . . . .                 | 9-13 |
| Tire Care Tips . . . . .                                    | 9-5  | Optional-Additional Steps for<br>Winterization . . . . . | 9-14 |
| Tire Inspection and Storage . . . . .                       | 9-5  | Water Heater Winterizing . . . . .                       | 9-14 |
| LPG SYSTEM . . . . .  | 9-6  | Macerator Pump Winterizing . . . . .                     | 9-15 |
| LPG Tank Remote Fill . . . . .                              | 9-6  | Toilet . . . . .   | 9-15 |
| Remote Gas Supply Switch . . . . .                          | 9-6  | Toilet Winterizing . . . . .                             | 9-15 |
| LPG Regulator . . . . .                                     | 9-6  | Maintenance . . . . .                                    | 9-15 |
| Exterior LP Port. . . . .                                   | 9-7  | Vehicle Storage. . . . .                                 | 9-16 |
| PLUMBING . . . . .  | 9-7  | Restoring Service . . . . .                              | 9-16 |
| Water System (Self-Contained) . . . . .                     | 9-7  | Exterior Door. . . . .                                   | 9-16 |
| Water Pump and Strainer . . . . .                           | 9-8  | Lubrication . . . . .                                    | 9-16 |
| Cleaning the Strainer . . . . .                             | 9-8  | Adjustments . . . . .                                    | 9-16 |
| Disconnecting the Strainer/Water<br>Pump Lines. . . . .     | 9-8  | ELECTRICAL DIAGRAMS . . . . .                            | 9-17 |
| Sanitizing . . . . .  | 9-9  | 12-Volt Main Schematic . . . . .                         | 9-17 |
| Sanitizing the Fresh Water Tank. . . . .                    | 9-9  | 30-Amp 120-Volt Schematic - USA and<br>Canada . . . . .  | 9-29 |
| Sanitizing the Fresh Water System . . . . .                 | 9-9  | Audio/Video Schematic . . . . .                          | 9-30 |
| DRAIN AND WASTE SYSTEM . . . . .                            | 9-10 | FRESH WATER LAYOUT . . . . .                             | 9-31 |
| Macerator Pump . . . . .                                    | 9-10 | FAQS AND ANSWERS . . . . .                               | 9-32 |
| Emptying the Black and Gray Water<br>Holding Tanks. . . . . | 9-11 |  |      |
| Macerator Impeller Release Feature . . . . .                | 9-11 |  |      |
| Manual Operation . . . . .                                  | 9-11 |  |      |
| Extended Stays . . . . .                                    | 9-11 |  |      |
| Black Water Tank Flush . . . . .                            | 9-12 |  |      |
| Drain System Cleaning . . . . .                             | 9-12 |  |      |

# Maintenance

## Maintenance Schedule

### **⚠ WARNING**

Failure to maintain your touring coach can cause premature and unexpected parts breakage and/or erratic operation that may be hazardous.

### **NOTICE**

See appliance manufacturer's literature for further information

#### Every 1,000 miles or 60 days

|                      |   |
|----------------------|---|
| Smoke and CO Alarm   | Test and replace battery as required.                                 |
| Tires                | Check tire pressure; <a href="#">see Specifications on page 4-3</a> . |
| GFCI Circuit Breaker | Test and record.  |

#### Every 5,000 miles or 90 days

|                             |  |
|-----------------------------|--|
| Door Step                   | Lubricate and inspect moving parts.                                      |
| Exterior Latches and Hinges | Lubricate with light household oil.                                      |
| LPG Regulator               | Check bottom vent for obstructions.                                      |
| Wheel Fasteners             | Torque to Specifications; <a href="#">see Specifications on page 4-3</a> |
| 7-Way Plug                  | Spray with contact cleaner.  |
| Exhaust fans                | Clean fan blades and wash filter, if supplied                            |

#### Every 10,000 miles or 6 months

|                         |  |
|-------------------------|--|
| Tires                   | Inspect and rotate.  |
| Windows, and Door Seals | Clean with mild detergent and apply 303 Aerospace Protectant |
| Exterior                | Wax  |

#### Every year

|                   |  |
|-------------------|--|
| Batteries         | Check terminals are secured  |
| LPG Tank          | Have purged by LPG supplier.   |
| Seams             | Check and reseal exterior seams, windows, lights, and vents as needed.               |
| Interior Cabinets | Visual inspection of latches and locks, hinges and slides. Silicone spray as needed. |

#### Every 100-150 hours

|           |  |
|-----------|--|
| Generator | Change oil after the first 20 hours of run time. |
|           | Change oil thereafter every 100-150 hours.       |

To break in the Onan generator run the generator at 50 percent load for two hours, then at 75 percent load for two hours. Refer to the Onan's manual for more details.

#### Mercedes-Benz Sprinter Van

Refer to your Sprinter Operator's Manual for important engine and vehicle maintenance intervals and adhere to onboard service notifications. Review the Sprinter manual's information and notes on maintenance, fuel grades, and Mercedes-Benz-approved operating fluids before refueling or servicing.

## Suggested Maintenance and Replacement Parts

Part numbers listed are Airstream part numbers and can be ordered by calling a certified Airstream dealer.

### ⚠ WARNING

**Always replace the bulb or light fixture with the correct bulb for that light or matching fixture. Failure to heed this warning could cause fire, property damage, personal injury, or death.**

#### Exterior 12-Volt Lighting – For additional exterior lights refer to your Chassis Owner’s manual.

|                                       |             |
|---------------------------------------|-------------|
| Grab Handle w/LED Light               | PN – 513037 |
| Light w/Motion Sensor & ON/OFF Switch | PN – 513224 |
| Yellow Marker/Clearance Light         | PN – 513885 |
| Red Marker/Clearance Light            | PN – 513886 |
| Light, 3rd Brake w/Eyeball Camera     | PN – 513031 |
| Taillight, RH                         | PN – 513227 |
| Taillight, LH                         | PN – 513226 |

**NOTE: Most Exterior Lighting is LED and a replacement fixture will be required.**

#### Interior 12-Volt Lighting

|                                      |                |
|--------------------------------------|----------------|
| LED Flex Tape Light, 45.63”          | PN – 513671-03 |
| LED Flex Tape Light, 53.5”           | PN – 513671-04 |
| LED Flex Tape Light, 35.4”           | PN – 513743-36 |
| LED Flex Tape Light, 53.1”           | PN – 513743-53 |
| LED Flex Tape Light, 23.5”           | PN – 513747-23 |
| LED Flex Tape Light, 86.75”          | PN – 513747-86 |
| LED Flexible Light w/USB Charge Port | PN – 513330    |
| LED Spot Light w/Frosted Lens        | PN – 512987    |
| LED Linear Diffused Light, 68”       | PN – 513072    |
| LED Aisle Light, Motion Activated    | PN – 513070    |
| Lightbar w/ON/OFF Switch, 16”        | PN – 513103    |

**NOTE: Most Interior Lighting is LED and a replacement fixture will be required.**

#### Replacement Breakers - USA Breakers

|                                 |                |
|---------------------------------|----------------|
| Breaker, Bryant, 20 Amp         | PN – 510564-01 |
| Breaker, Bryant, 30 Amp         | PN – 510564-02 |
| Breaker, Bryant, 20-20 Amp      | PN – 510564-04 |
| Breaker, Bryant, 15 GFCI Amp    | PN – 510564-07 |
| Breaker, Bryant, 20-15 Amp      | PN – 510564-08 |
| Breaker, 12V DC Type II, 8 Amp  | PN – 510947-08 |
| Breaker, 12V DC Type II, 15 Amp | PN – 510947-15 |
| Breaker, 12V DC Type II, 20 Amp | PN – 510947-20 |
| Breaker, 12V DC Type II, 30 Amp | PN – 510947-30 |

| Replacement Rivets  |              |              |              |
|---|--------------|--------------|--------------|
| Interior  |              |              |              |
| Part Number   | 330164       | 330134-05    | 325121-03    |
| Rivet Name  | MGL100-U6-9  | RV6601-0604S | RV6607-6-8   |
| Head Style  | Flush Head   | Countersunk  | Shaveable    |
| Body Diameter (Inches)  | 0.187 (3/16) | 0.205 (3/16) | 0.205 (3/16) |
| Hole Size   | 0.191-0.201  | 0.209-0.221  | 0.209-0.221  |
| Drill Number  | NA           | 4            | 4            |
| Grip Range In (Inches)  | 0.305-.500   | 0.106-0.250  | 0.050-0.500  |
| Length Under Head (Max. Inches)   | 0.929        | 0.935        | 1.00         |
| Head Diameter (Nominal)   | 0.345        | 0.340        | 0.469        |
| Head Height (Max. Inches)   | 0.070        | 0.103        | 0.094        |
| Typical Sheer Strength (lb)*  | 1300         | 675          | 675          |
| Typical Tensile Strength (lb)*  | 950          | 450          | 450          |
| *Values shown are a guide only and may vary depending upon the application. |              |              |              |

| Replacement Filters |                 |
|---------------------|-----------------|
| Air Conditioner     | PN – 690699-100 |

| Interior Touch-up               |                |
|---------------------------------|----------------|
| Seam-Fil, Macchiato             | PN – 360301-13 |
| Seam-Fil, White                 | PN – 360301-02 |
| Seam-Fil, Black                 | PN – 360301-04 |
| Fil-Stik, Macchiato, Earth Tone | PN – 360406-04 |
| Fil-Stik, Macchiato, Caramel    | PN – 360406-10 |
| Fil-Stik, Black                 | PN – 360406-29 |
| Fil-Stik, White                 | PN – 360406-18 |

## Exterior Care

The following exterior care products are recommended by Airstream. Read and follow label directions. Exterior sealant should be checked and resealed once a year.

**Walbernize Super Seal (PN - 28433W)** - Use to clean and polish while depositing a reflective, water-proof, glaze finish. Recommend two applications a year.

**Acryl-R Seam Sealer (PN - 28430W-01 [16 oz can-Gray])** - Use anywhere a fine bead of gray sealant is required.

**AdSeal Premium Quality Sealant Adhesive (PN - 365330-01 [10 oz tube-White])** - Use anywhere a thicker bead of White sealant is required.

**AdSeal Premium Quality Sealant Adhesive (PN - 365330-02 [10 oz tube-Gray])** - Use anywhere a thicker bead of gray sealant is required.

**AdSeal Premium Quality Sealant Adhesive (PN - 365330-04 [10 oz tube-Black])** - Use anywhere a thicker bead of Black sealant is required.

**Sikaflex 221 Multi-Purpose Polyurethane Sealant (PN - 360180-04 [10 oz tube-Black])** - Use to seal below the rubrail, or anywhere a thicker bead of black sealant is required.

| Airstream Touch-up Paint Codes |      |
|--------------------------------|------|
| Iridium Silver (Mercedes)      | 9775 |



## Tire Care

The most important function of tires is to provide traction while moving and grip when steering or stopping. The tires on your touring coach are designed for highway use and must be properly maintained in order to maximize tire life, as well to provide a safe mode of transportation. For more information on changing a tire and tire inflation, [see Tires on page 7-4](#).

### Tire Care Tips

To reduce the risk of tire failure, we strongly recommend the following:

1. Check the pressure in your tires at least monthly when the tires are cool (after the vehicle has been stopped for 3 hours and then driven less than 1 mi). Do not reduce pressure when tires are hot. Use a tire gauge to check pressure and maintain it at the recommended level.
2. Never overload your tires. Heed the maximum load-carrying capability of your tires.
3. Check your tires frequently for scrapes, bulges, separations, cuts, or snags resulting from use. See your tire dealer immediately if any such condition is discovered.
4. Never operate your vehicle in excess of lawful speeds, the maximum speeds justified by driving conditions, or in excess of speeds recommended for the tires you are using.
5. Make every effort to avoid running over objects that may damage the tire through impact or cutting, such as chuck holes, glass, metal, etc.
6. Never drive on smooth tires. Tires should be removed when 2/32 in. of tread depth remains. In most states, it is illegal to drive with less than 2/32 in. remaining tread depth.
7. Park out of the sun whenever possible when in warm climates. In desert regions, use tire covers to prevent ultra violet light deterioration to tires.

## Tire Inspection and Storage

Before taking your touring coach on a trip or when removing it from an extended storage period, make it a practice to inspect the overall condition of your tires. Check for any type of condition or damage that might result in failure. A thorough check should include both inside and outside sidewalls, tread area, and the condition of hardware such as valve stems, valve caps, and wheels. The tread should be checked for any unusual wear, cracking, penetrations, and/or cuts. An uneven wear pattern can indicate misalignment or worn suspension parts.

Since many touring coach's are used seasonally and sometimes stored for extended times, it is possible that tires will take many years to wear out. Tires, as any rubber product, will age over time. If tires show cracking in the sidewall or tread surfaces that are more than 2/32-in. deep, they should be replaced before your next trip or vacation. Store your touring coach in a cool, dry area away from major heat sources and extreme cold. An enclosed storage area is best with no exposure to electromagnetic sources such as generators or transformers. If you must keep your touring coach outside, cover your tires from direct sunlight. Take your touring coach to your tire dealer for service to check or correct any of these conditions.

### **⚠ WARNING**

**Wheel fastener torque must be checked immediately after reinstalling a wheel and again after 30 miles. Torque all wheel fasteners evenly to specification using the proper sequence; [see Wheel Bolt/Lug Nut Tightening on page 7-8](#). For torque values, [see Specifications on page 4-3](#).**

## LPG System

Your touring coach is equipped with a permanently-mounted tank for LPG with a remote fill and remote gas supply shut off switch. LPG burns with a clean blue flame. LPG is used where subfreezing temperatures are common, since it boils at -44°F. Keep in mind at these temperatures the BTU is lower than at 30°F. How long a full tank of gas will last is dependent on usage. In cold weather, when you are using the furnace, using large amounts of hot water, or cooking extensively, you will naturally use more LPG than you will in warm weather, or when doing limited cooking. On the average, with normal cooking and other appliance use, you can probably count on a few weeks of usage from the tank, if you are not running your generator.

If you have allowed the tank to run out, air may have gotten into the lines. In this event the air must be allowed to bleed from the lines before lighting appliances. Follow the appliance manufacturer's instructions and light the appliance closest to the LPG supply tank. Then move to the next closest, etc.

### LPG Tank Remote Fill

The LPG tank is filled by accessing the remote fill hookup located in the rear utility compartment on the passenger side. Be sure the fill is free of dirt. It may help to remind your LPG supplier to only use a clean fill hose to fill your tank. Turn off the remote switch when the LPG system is not in use, as it draws 12-volt current from the batteries

#### **⚠ WARNING**

Only certified LPG suppliers should fill the LPG tank. Turn remote gas supply switch off before filling or refilling LPG tank.

#### **⚠ WARNING**

Always shut off the LPG gas when refueling the touring coach.

## Remote Gas Supply Switch



A remote switch for shutting off the gas to all appliances is located in the curbside rear utility compartment. The switch activates an electric solenoid which opens and closes, shutting the gas off at the tank. This switch should be turned off during the filling of the LPG tank or when LP is not needed to fuel appliances.

Gas lines should be checked periodically for leaks with ammonia-free soapy water.

#### **⚠ WARNING**

Be careful when working around electricity, as it can carry dangerous amperage and cause sparks or combustion.

#### **NOTE**

The electric gas shut-off solenoid closes automatically when 12-volt power is disconnected. It will reopen when power is restored.

#### **⚠ WARNING**

All LP gas appliances must be turned off during refueling of touring coach fuel tanks and permanently-mounted LPG tank.

#### **⚠ DANGER**

Do not use open flame to search for problems. If gas can be smelled, appliance pilots fail to stay on, or any other abnormal situation occurs, use the remote supply switch to shut off the tank valve immediately and call on a qualified LPG service center or Airstream Service Center.

## LPG Regulator

The LPG regulators used on Airstream Touring Coach's are designed for low-pressure service, with a normal outlet pressure setting of 11"-14" water column. Only personnel trained in the proper procedures, codes, standards, etc., should service regulators. Have the regulator inspected each time the tank is refilled. Replace any regulator that has had water in the spring case, or shows evidence of external corrosion or corrosion inside the spring case.

## **⚠ WARNING**

**Moisture in the LPG tank will cause a malfunction of the regulator in controlling proper pressure. This may result in the flame lifting off the burner or going out frequently. Many refueling stations will add approximately ¼ to ½ gal of alcohol allowing moisture to pass through the regulator without the formation of ice crystals.**

### Exterior LP Port

A quick-connect, low-pressure LPG connection is located under the passenger side rear quarter panel behind the dual wheels. It is a utility connection for use of an outside grill or other LPG appliance. Check that the remote LPG shut off switch is turned off. Slide the collar on the female end back and plug the male hose into the connection. Release the collar and check that the hose is properly connected by giving a firm pull on the hose. Turn the LPG remote shut off switch on and recheck all connections to the appliances and quick connection to be sure no leaks are present. Follow all instructions, cautions, and warnings in this manual when connecting and disconnecting appliances.

## Plumbing

### Water System (Self-Contained)

The fresh water system consists of a city water hookup, fresh water tank and drain valve, water pump, hot and cold water lines, water heater, and faucets. Full explanations on the locations and use of these features are explained in this section.

Before using the water system, check that the water heater bypass valve is turned to the use position. Make sure the fresh water tank drain valve is closed; [see Component Locations for Winterization on page 9-13](#).

The water tank can be filled by connecting a potable water hose to the city water inlet and turning on the fresh water valve switch. A high-pressure RV/Marine FDA approved drinking water hose of at least ½-in. diameter made from material that is tasteless, odorless, and non-toxic should be used. It's a good idea to let the water run through the hose for a short time to flush it out. RVers sometimes fill their tanks with "home" water to avoid strange water that may be distasteful to them on short outings. Remember, the more water you carry in the Fresh Water tank, the less cargo carrying capacity you have for other items. The amount of water in the tank may be checked on the Multiplex Control Panel. The fresh water valve switch will automatically turn off when the tank is full.

Because the water heater is tankless it does not need to be filled. However, if the system has not been used for some time or is being used for the first time since draining the lines it is normal for air to have gotten into the lines. To expel the air, open the hot side of either the galley, wet-bath, or exterior shower faucet and turn on the water pump or connect to an exterior city water source. Close the cold side of all faucets. For some time the open faucet will only sputter. This is because the air is being pushed out through the lines. Once the air is expelled, a steady stream of water will come from the faucet.

Now, open a cold faucet. It will sputter for a short time, but will soon expel a steady stream. All other faucets can now be opened until all air is expelled.

Once the system is filled with water and the faucets are closed, the water pump will shut off. When a faucet is opened, the pump will come back on automatically. If the faucet is just barely open, it is normal for the pump to cycle on and off rapidly.

It is normal for a pump to occasionally cycle when all faucets are off to keep the water pressure at the set point. However, if it cycles frequently (e.g. more than a few times an hour) the plumbing system, pump, and pump strainer should be checked to be sure it is not losing pressure through a slow water leak or back through the pump.

## **NOTICE**

**To prevent equipment damage, the water heater should only be started after the water system is primed and ready for use.**

## **NOTICE**

**Turn the water pump off when the touring coach is left unattended or in motion.**

# Maintenance

## Water Pump and Strainer

The water pump and strainer are located under the bathroom sink, accessed by opening the doors and removing the back panel. The water pump is controlled by the main Multiplex control panel or the panel located in the galley. Once the switch is turned on, the pump will run until the water pressure reaches approximately 55 psi. At this point, an internal pressure switch will shut it off. When a faucet is opened, the water pressure will drop and the pump will start to run again.

As a general rule, the water pump should be turned off while using a city water hookup; however, the water pressure at some campgrounds may be low. The water pump can be turned on to assist the city water hookup pressure. Be sure there is some water in the fresh water tank. The pump will only use the water that is needed out of the tank to bring the pressure up to the usual standard of 55 psi.

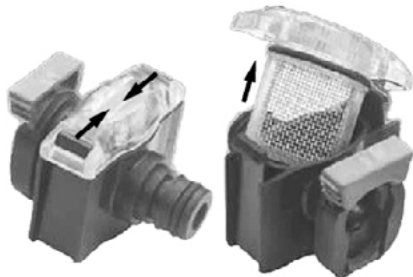
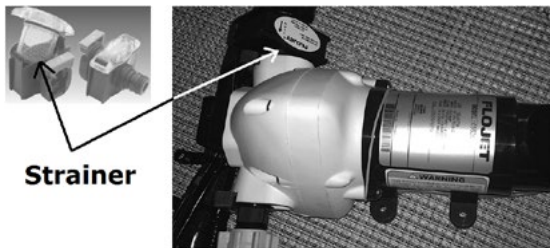

## Cleaning the Strainer

Visually inspect it for accumulation of dirt/debris that could affect water flow and clean as needed:

1. Rotate the strainer housing to a position allowing access to the clear-view screen retainer and the tabs holding it in place.
2. Pinch the tabs inward to release the clear plastic retainer (as shown on previous page).
3. Pull the retainer and screen out of the housing for cleaning. Rinse all debris from the screen.
4. Replace the screen assembly by aligning the screen in the seating grooves and pressing down gently until the tabs are back in place.

## Disconnecting the Strainer/Water Pump Lines

The inlet and outlet hoses and the strainer assembly are held in place by self-sealing, blue, quick-connect fittings:

1. Grasp the blue tab on the female fitting by the grooved finger edges and pull straight out on the tab to release the male fitting.
2. Be sure that both the female and male fittings on the disconnect are free of all debris and damage before replacing them.
3. Check the pump system for leaks when reinstalling the disconnect fittings.

### NOTICE

**Failure to check the quick disconnect fitting for water leaks when reinstalling inlet and outlet hoses or the water pump strainer may cause the system to leak, causing damage to personal property.**

## Sanitizing

Potable water systems require periodic maintenance to deliver a consistent flow of fresh water. Airstream recommends sanitizing before and after storage, after new component installation, and if the system is contaminated. When determining how often to sanitize the system, consider environmental factors, usage, and the quality and taste of the water from the system.

The following instructions are for the use of bleach. If using an RV fresh water cleaner and deodorizer, follow the instructions on the container for mixture and contact time.

For the following procedures, you will need to know how many ounces of bleach to add to your bleach/water mixture. Multiply “gallons needed” by 0.13; the result is the ounces of bleach needed. Double the amount of bleach to reduce disinfection time from four hours to one.

### Sanitizing the Fresh Water Tank

1. Determine the amount of bleach you need for your tank capacity using the calculation above. For tank capacity, [see Specifications on page 4-3](#). Pour the bleach into a 1-gallon container and fill it with water to make a bleach/water concentrate.
2. The fresh water tank sanitization kit is located under the galley and is best accessed by removing the trash can and lower drawers. The kit has a clear plastic tube. Feed the tube through the trash can cutout and attach a funnel.

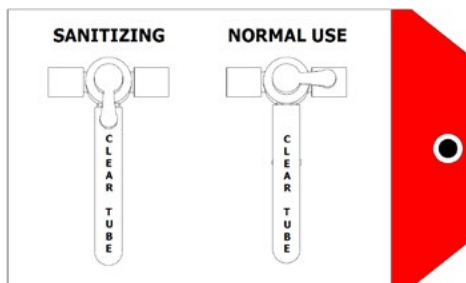

3. The kit's valve is at the end of the tube and may require careful maneuvering around components to gain access. Turn the valve from NORMAL USE to SANITIZING and carefully pour the bleach/water concentrate into the funnel to gravity feed it into the fresh water tank.

4. Fill the tank using a city water connection and leave the solution in the tank for 4 hours of contact time to complete the disinfection process. Or, if doubling the required bleach, 1 hour.
5. Drain the tank, refill from the city water connection, and drain again. Repeat until the bleach solution is flushed out.

### Sanitizing the Fresh Water System

It is possible to sanitize the system using the steps above to fill the tank and then fill the system using the water pump. However, if you are only sanitizing the lines, a simplified method is to use the winterization kit in combination with the water pump to pull sanitizing fluid from containers. Mix 2-3 gallons of sanitizing solution. To introduce the solution follow the [Optional-Additional Steps for Winterization on page 9-14](#). Leave the solution in the system for 4 hours of contact time to complete the disinfection process. Or, if doubling the bleach concentration, 1 hour. Flush the system with fresh water using a city water connection.

## NOTE

**This sanitizing procedure is in conformance with the approved procedures of RVIA ANSI A 119.2 and the U.S. Public Health Service.**

## Drain and Waste System

Your touring coach has a drain and waste system that includes waste-holding tanks made from corrosion-free, molded plastic, with trouble-free dump valves.

The main (Black Water) holding tank enables you to use the toilet for several days away from disposal facilities. The waste water from the sinks and shower, drain into the auxiliary (Gray Water) holding tank.

Each tank has its own dump valve with both tanks draining through a common outlet. Therefore, only one sewer hose connection is needed when hooking up to a dump station.

Almost all campgrounds will have dumping facilities. Park directories, such as Woodalls and Rand McNally, also list dumping stations. Furthermore, the navigation systems GPS can be used to locate nearby dumping stations or highlight stations along your route.

Check your monitor panel frequently (main Multiplex control panel or Seelevel monitor). When the Black Water holding tank is completely full, sewage cannot be emptied from the toilet bowl. If the Gray Water holding tank is overfilled, drain water will back up into the shower floor pan and cause an unpleasant cleaning job. Never drain the tanks at any place other than an approved dumping station.

### NOTICE

**Do not use a pipe snake on clogged drains as it could result in damage to internal components of the drain system.**

### NOTICE

**Never put wet strength paper towels or tissues in your holding tank since they will not dissolve and can catch in the mechanism of the dump valve. Colored toilet tissue is slower to dissolve than white. Most motorhome accessory stores offer tissue designed for RV's that will completely dissolve.**

## Macerator Pump

The waste pump is the ideal solution for emptying holding tanks on touring coach's. The macerator section grinds waste down to a particle size of 1/8-in. maximum. The waste pump will macerate and pump all waste and tissue normally found in recreational vehicle waste systems.

### ⚠ CAUTION

**The waste hose is pressurized when operating the macerator pump. Secure the loose hose end at the disposal facility with supplied inlet adaptors before turning on pump.**

The high-pressure waste hose is stored on an electric hose reel and connected to the Discharge Port Adaptor. It has a threaded, drip-proof valve with a versatile, two-size, threaded adaptor allowing the valve to be connected to 3 sizes of threaded inlets, including an exterior home sewer clean-out. The adaptor snaps over the valve threads. A rubber ring is also provided to lodge into a non-threaded inlet. If the rubber ring seems loose when used, Airstream recommends using some type of weight to further secure the hose.

Each holding tank, the macerator pump, and macerator pump electric hose reel have individual switches which are located in the roadside rear utility compartment. Each valve switch has a light that illuminates to let you know the valve is opened. Pressing a dump valve switch and holding it for 2-3 seconds until it is lit opens a holding tank valve. Pressing it again for 2-3 seconds closes it. The macerator pump has an ON/OFF toggle switch. The reel has a switch for releasing and retracting the hose, once the hose is released it is deployed manually by pulling the hose out. To retract the hose, press and hold the retract button while guiding the hose back and forth onto the reel evenly.

### NOTICE

**Do not run Macerator pump more than 15 minutes continuously. Do not run the Macerator pump dry for more than 30 seconds. THE MACERATOR WILL NOT HANDLE HARD SOLID OBJECTS, SANITARY NAPKINS OR RAGS. Never put wet strength paper towels, tissues, or sanitary napkins in your holding tank. They will not dissolve and will jam the mechanism of the dump valve and the macerator pump impeller.**

## Emptying the Black and Gray Water Holding Tanks

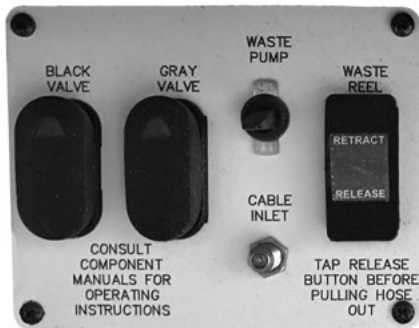

1. Remove the high pressure waste hose by opening the hose reel compartment door and momentarily pressing the “release” switch. Once released, the hose can be manually pulled out. Secure the hose at the disposal facility inlet using the threaded or rubber adaptor and open the drip proof valve on the end of the hose.

### **CAUTION**

**The pressure from the macerator pump may push the hose from the inlet if the hose is not secured properly.**

2. Open the Black Water valve. Empty the Black Water tank first and the Gray Water tank second, using the Gray Water to help flush the pump and hose of Black Water sewage.
3. Turn on macerator pump to liquefy and pump out the solids in the tank.
4. When the black tank is empty, turn off the pump.
5. Open the Gray Water tank valve and turn on the pump. Run until just before the pump runs dry. Any trickle of gray water left will remain in discharge hose behind drip proof valve and is typical. Remember, running the pump dry for more than 30 seconds could damage the pump.
6. Turn the drip-proof valve off and remove the hose adaptor from the dump station inlet. Retract the hose into the hose reel by holding the switch in the “retract” position. Be sure to guide the hose back and forth onto the reel evenly. Close the compartment door.

### **NOTICE**

**Watch all connections while dumping. Close dump valve immediately, turn off pump, and close hose drip-proof valve if a leak is noticed.**

## Macerator Impeller Release Feature

Impeller Release Feature



After long periods of non-use, a stuck impeller can be easily broken loose with a screwdriver inserted in the motor shaft slot. Remove the rubber boot, turn the shaft clockwise, and replace the rubber boot. The impeller can usually be found under the touring coach, near the macerator hose reel.

### **Manual Operation**

In case the electric dump valves fail to open, manually pull/push the arm once, to open and close the valve. The manual arm located under the vehicle, near the macerator hose reel.



### **Extended Stays**

When you are in a park with a disposal facility, empty the tanks every few days or whenever they become almost full. Pumping a large volume of liquid through the tanks at a time will keep toilet paper and other solids completely washed away. Remember to empty the Black Water tank first and then the Gray Water tank using the Gray Water to flush the system. This practice will avoid the accumulation of solids in the tank, which could lead to an unpleasant cleaning job.

Should solids accumulate, fill the tank about half full with water using the black tank flush inlet, and then drive the touring coach for a few miles. The turbulence and surging of the water will usually dissolve the solids into a suspension so the tank can be drained. Draining the tanks as described will protect them from freezing during storage.

## Black Water Tank Flush



Airstream advises flushing the black water holding tank each time it is emptied to prevent clogging of the water jets and accumulation of waste solids inside the tank. Start by emptying the holding tanks at an approved dump station, close the black tank valve, and leave the macerator hose connected to the drain. To flush the tank:

1. Attach a water hose to the flush inlet inside the macerator hose compartment (do not use the fresh water tank hose for this purpose).
2. Turn the water on and monitor the black tank level. Fill the tank about half full and turn the water off.
3. Open the waste holding tank valve (press and hold the rocker switch labeled "Black Valve" until the switch illuminates).
4. Open the valve at the end of the macerator hose. Turn the macerator pump ON to empty the tank. As soon as it is empty turn the pump OFF (running the pump dry more than 30 seconds can damage it).
5. Close the waste holding tank valve (press and hold the rocker switch until the light turns off). Repeat this process until the water runs clear, retract the hose, and lock the compartment door.

## Drain System Cleaning

The only cleaning agents that can be used without causing harm to the system are household ammonia and tri-sodium phosphate in small quantities. Do not use any product that contains any portion of petroleum distillates. This type of product will attack the rubber seals of your toilet and dump valve. Also, do not use any dish detergent or abrasive cleaners. All products should be marked as approved for ABS drainage systems.

## Winterizing and Storage

When storing your touring coach, use the same precautions as you would in your own home in regard to perishables, ventilation, winterizing, and rain protection. In addition, for prolonged storage periods, flush out all the drain lines and waste holding tanks. Also, drain the entire water system, including the water heater and the fresh water tank. Instructions for draining the water system are explained in the following paragraphs on winterizing.

Twice a year, or after a long storage period, we suggest you take your unit into your Airstream dealer for a check-up and cleaning of the gas-operated appliances.

The main consideration in winterizing is to guard against freezing damage to the fresh water lines, the waste drain lines, the waste holding tanks, the water heater, and the batteries.

### NOTICE

**Sprinter recommends disconnecting the current to all chassis electric consumers using the engine battery disconnect cable if the vehicle sits for periods longer than 30 days. This will save jump starts, battery charge ups, and possible battery damage and replacement. The Mercedes-Benz Sprinter Operator's Manual describes its location, operation, and cautions in detail.**

### NOTICE

**In very cold weather, winterizing the motor coach is recommended to prevent damage to the waste systems.**

## Touring Coach Winterization

To perform these steps, you will need an adapter with an air regulator to connect an air compressor to the city water inlet, and access to an air compressor. Adapters are available at most RV stores.



### **Component Locations for Winterization**

Fresh water tank drain valve - under the touring coach; in front of the roadside wheels.

Water heater drain valve - on the water heater; under the galley, accessed by removing the galley drawers.

Water heater bypass valve - on the water line connected to the water heater.

Water pump - under the bathroom sink, accessed by opening the doors and removing the back panel.

Winterization kit - under the bathroom sink, accessed by opening the doors and removing the back panel.

### **Instructions for Winterization**

1. Level the touring coach from side to side and front to rear, turn the water pump OFF, and disconnect the city water.
2. OPEN all the hot and cold water faucets.
3. OPEN the fresh water tank drain valve.
4. OPEN the water heater drain valve.
5. Allow all water to stop draining and proceed to the next step.
6. For this step, you will need someone to operate the toilet foot pedal/flush valve. Using the air compressor, apply at MAX 30 PSI of air pressure at the city water inlet until no water remains in the system. Operate the foot pedal on the toilet. You may need to depress the pedal a few times to work out all the water by allowing some air pressure to build up between flushing. Once all the water has been blown from the system, disconnect the air and continue to the next step.
7. For this step, have a catch pan or a towel ready to place under the water pump outlet to prevent water from running out into the touring coach. Remove the quick-connect outlet fitting from the water pump. Turn the pump ON briefly to remove any remaining water from the pump head and lines running from the tank.
8. Check the water pump strainer to be sure no water remains.
9. If you plan to add RV antifreeze using the optional steps below, RECONNECT the water pump. Otherwise, leave the fittings from the pump disconnected until the system is ready to be used again. Best practice: leave a note as a reminder near the multiplex panel that the water pump is disconnected.
10. If you plan to add RV antifreeze using the optional procedure below, save this step for the end. Otherwise, for best practice: REMOVE the house batteries from your touring coach and store them in a cool, dry place where there is no danger of freezing. During extended storage periods, especially in cold weather conditions, check the batteries periodically and keep them fully charged for optimal life. If the storage period is 30 days or less, you can turn off the battery disconnect switch rather than remove the batteries.

### **NOTICE**

**Do NOT exceed MAX 30 PSI when using compressed air to clear the system of water during winterization. Higher pressures may damage the water heater.**

### **NOTICE**

**The MAX 30 PSI can be increased to a MAX 50 PSI if the water heater bypass valve has been set to its bypass position. CAUTION - if 30 PSI is exceeded with the bypass valve in the normal use position, the water heater could be damaged.**

# Maintenance

## Optional-Additional Steps for Winterization

An additional step to winterization is to consider adding a non-toxic RV antifreeze (approved for drinking water systems) to the water lines using the Winterization Kit to draw RV antifreeze into the water system, using the water pump.

Before beginning, read the RV antifreeze manufacturer's label for instructions specific to the antifreeze you plan to use. It may take a few gallons to fill the entire system so prepare accordingly. As you follow these steps, it will be helpful to have another person watching and operating the faucets, shower heads and toilet valve.

1. RECONNECT all lines and CLOSE all drain valves.
2. OPEN the sink and shower drains if they are closed.
3. Ensure all the water faucets and shower heads, hot and cold, internal and external, are OPEN.
4. Locate the Winterization Kit under the bathroom sink behind the access panel, uncoil the hose, and insert it to the bottom of the RV antifreeze fluid container.

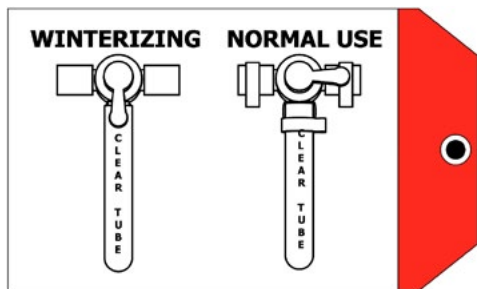

5. Turn the valve from NORMAL USE to WINTERIZE (as shown above).
6. Turn the water pump ON and run it until antifreeze starts coming out of the faucets. Once antifreeze is running from the taps you can start closing them. Move from one fixture to the next, shutting them off as you go until all the lines are full. Turn the pump OFF as you empty and transition from one antifreeze container to the next.
7. Allow the antifreeze to flow down drains. Flush the toilet and allow antifreeze to flow down the toilet. If equipped, operate the toilet hand sprayer until antifreeze is coming out. If equipped, work the hand shower sprayer while holding it down in the shower until antifreeze is coming out, and do the same with the external shower head. Dump any remaining small amounts of antifreeze down a drain.

8. Shut the water pump OFF once all the lines are full.
9. OPEN all the faucets and leave them open.
10. DISCONNECT the hose, rinse it out with fresh water and store.

## NOTICE

**Remove all RV antifreeze spillage from all sinks, drain pans, and faucet parts after winterizing. Failure to do so could damage surface finishes. Do not use water to rinse antifreeze down the drain as it will dilute the antifreeze.**

11. Complete step 10 from the previous set of instructions.

## Water Heater Winterizing

If the touring coach is to be stored during winter months, the water heater system must be drained to prevent damage from freezing. Once drained RV non-toxic antifreeze can be added.

1. Turn off electrical power to water heater by using the on control center or by removing the fuse.
2. Shut off gas supply to water heater.
3. Turn off water pump.
4. Open both hot and cold water faucets.
5. Remove service panel to access system drain valve. The water heater is located under the galley and accessed by removing the galley drawers.



6. Turn drain valve knob clockwise to drain and then clockwise again to close.
7. Follow the Winterizing and Storage instructions for draining entire water system.

## NOTICE

**System will have to be refilled with water and all air removed from lines before unit will re-light.**

## Macerator Pump Winterizing

Plan your winterizing and storage ahead, and be sure the holding tanks are drained and flushed thoroughly. This is very important, as the frozen sewage and water could seriously damage the system. After dumping tanks, add RV, non-toxic antifreeze to one of the holding tanks and start the macerator pump. Run the pump until the RV, non-toxic antifreeze comes out the end of the pump hose, then close the dump valve. As extra protection, open the toilet valve and add RV, non-toxic antifreeze through the toilet into the Black Water tank and pour RV, non-toxic antifreeze into a sink drain to protect the holding tanks, valves, and pump from residual water freezing.

## Toilet

### Toilet Winterizing

Draining Method: Turn off the touring coach's water supply. Drain toilet bowl. Disconnect supply line at water valve. Completely drain the toilet's water supply line.

### NOTICE

To avoid damage when using air pressure to blow water from the lines, make sure toilet valve is in the open position.

### NOTICE

If water is frozen in the toilet, do not attempt to flush until the ice thaws. Never use automotive type antifreeze.

## Maintenance

If the bowl-sealing blade does not operate freely after extended use, it may be restored to its original, smooth operating condition by applying a light film of silicone spray to the blade. To clean the toilet use SeaLand® Toilet Bowl Cleaner or any other high grade, non-abrasive cleaner. Do not use highly concentrated or high acid content household cleaners. They may damage the rubber seals.

## Troubleshooting

1. Leaks:
  - a. Back of toilet: check water supply line connection at water valve. Secure or tighten as necessary. If leak persists from water valve, replace.
  - b. Vacuum breaker leaks while flushing: make sure vacuum breaker stem is pushed fully into sealing grommet in back of bowl. If leak continues replace vacuum breaker.
  - c. Between closet flange and toilet: check flange nuts for tightness. If leak continues, remove toilet and check flange height. Replace flange seal.
2. Toilet won't hold water:
  - a. Check for and remove any debris from blade-ball seal track.
  - b. Check blade/ball seal compression mechanism. If blade/ball seal is worn, replace.
3. Harder than normal pedal operation: Apply light film of Thetford Toilet Seal Lubricant & Conditioner or silicone spray to blade/ball. (Note: To avoid damage, do not use spray lubricants other than silicone.)
4. Poor flush: The pedal must be held completely down to flush. A good flush should be obtained within 2 to 3 seconds. If problem persists, remove the water supply line and check flow rate.

# Maintenance

---

## Vehicle Storage

In addition to winterizing your coach, the following practices are recommended to prevent damage that can occur during storage:

- Because brake fluid absorbs moisture from the air, Mercedes-Benz recommends changing the brake fluid when the vehicle is not driven for long periods or when stored for over six months.
- Do NOT use any fuel additives for storage.
- Fill the fuel tank to FULL before storage and use diesel fuel with a bio-diesel content of 5% (B5) or less to avoid moisture buildup and contamination. Storing the vehicle with B20 fuel is not recommended as it may promote algae growth. Do not store the vehicle for more than 30 days with B20 diesel fuel in the tank.
- Keep the coach plugged in so the battery maintainer can charge and maintain the chassis battery.
- While it is not required, you may opt to change the oil before storage to flush out any contaminants.
- Move the vehicle regularly or use tire-saver ramps to help prevent flat spotting. Tires can be inflated to 80 PSI to help prevent flat spotting, but they must be inflated to the correct pressure before driving. Keep a note on the vehicle or with the keys as a reminder to adjust the tire pressure prior to driving. If tire-saver ramps are not used, move the vehicle a few feet periodically to avoid flat spotting.
- Clean the interior of the vehicle and remove all food and beverage items. Empty, clean, and turn off the refrigerator and leave the door open to avoid mold growth. If mice or other rodents enter the vehicle, they can chew through wiring and cause significant damage. Consider using a rodent repeller.

## Restoring Service

1. Re-install the fully charged house batteries.
2. Close the holding tank dump valve, water faucets, and fresh water tank drain.
3. Reconnect water pump line.
4. Add water to the fresh water tank.
5. Turn the water pump on.
6. Open and close faucet valves one at a time until water runs clear at all faucets signaling RV, non-toxic antifreeze is flushed out of lines. Go back and recheck water clarity at all faucets.
7. Turn off the water pump.
8. Hook up city water, open faucet valves, and recheck water clarity.

Close water heater drain valve and reset water heater bypass valve to normal operating position.

## Exterior Door

### *Lubrication*

Apply a little paraffin or grease to the striker pockets and a slight amount of household oil to the lock mechanisms to keep the locks operating smoothly. Also, lubricate the hinge pins periodically with household oil. Use the lubricant sparingly and remove any excess immediately.

### *Adjustments*

Door adjustments can be affected by:

- The coach being improperly leveled.
- Striker bolt alignment being out of adjustment, (striker bolt is adjustable).

Check the fit of your door before and after leveling. The fit of the door can be affected if the coach is not level side to side and front to back.



## 12-Volt Schematic

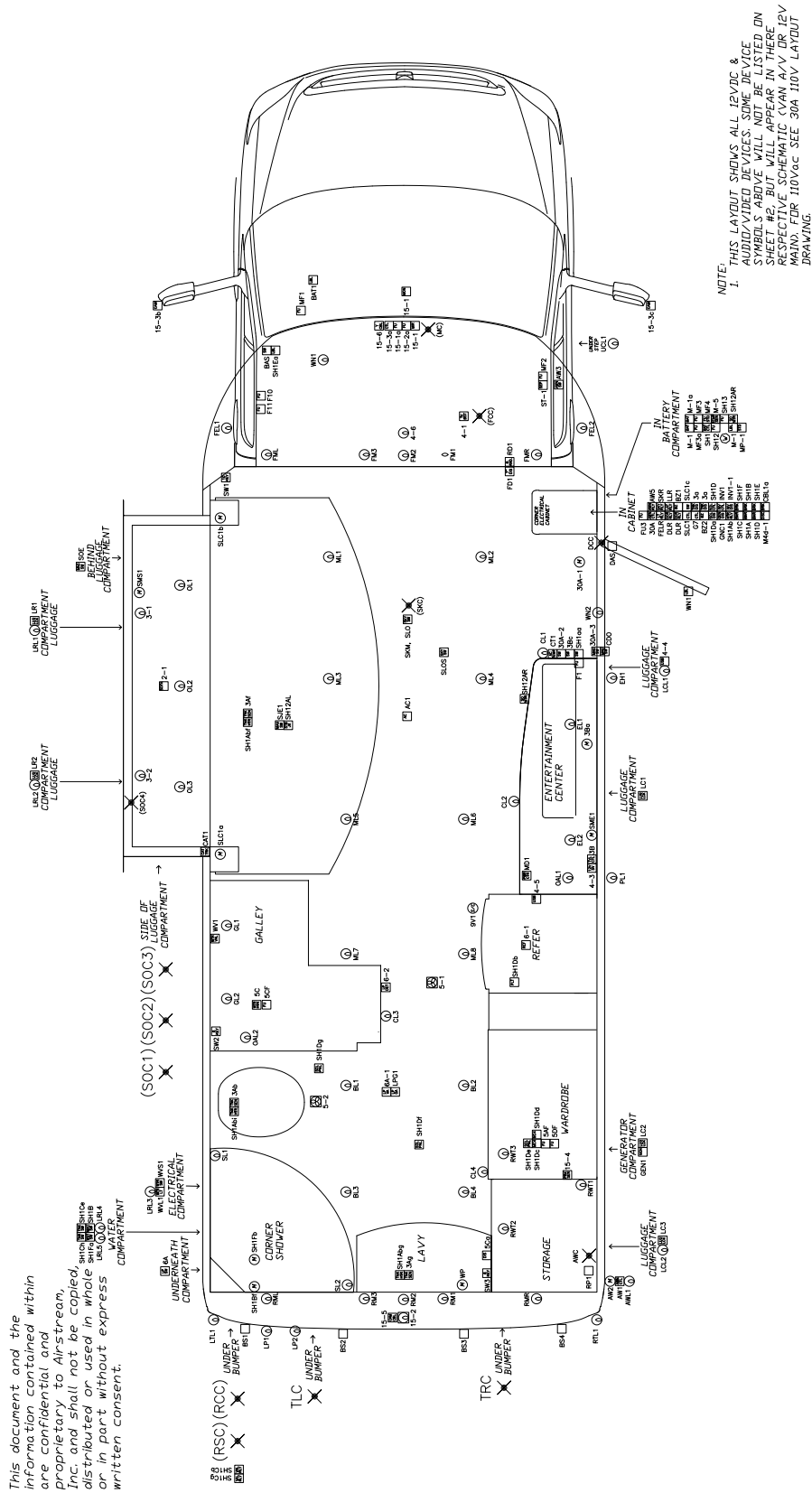

## 12-Volt Schematic

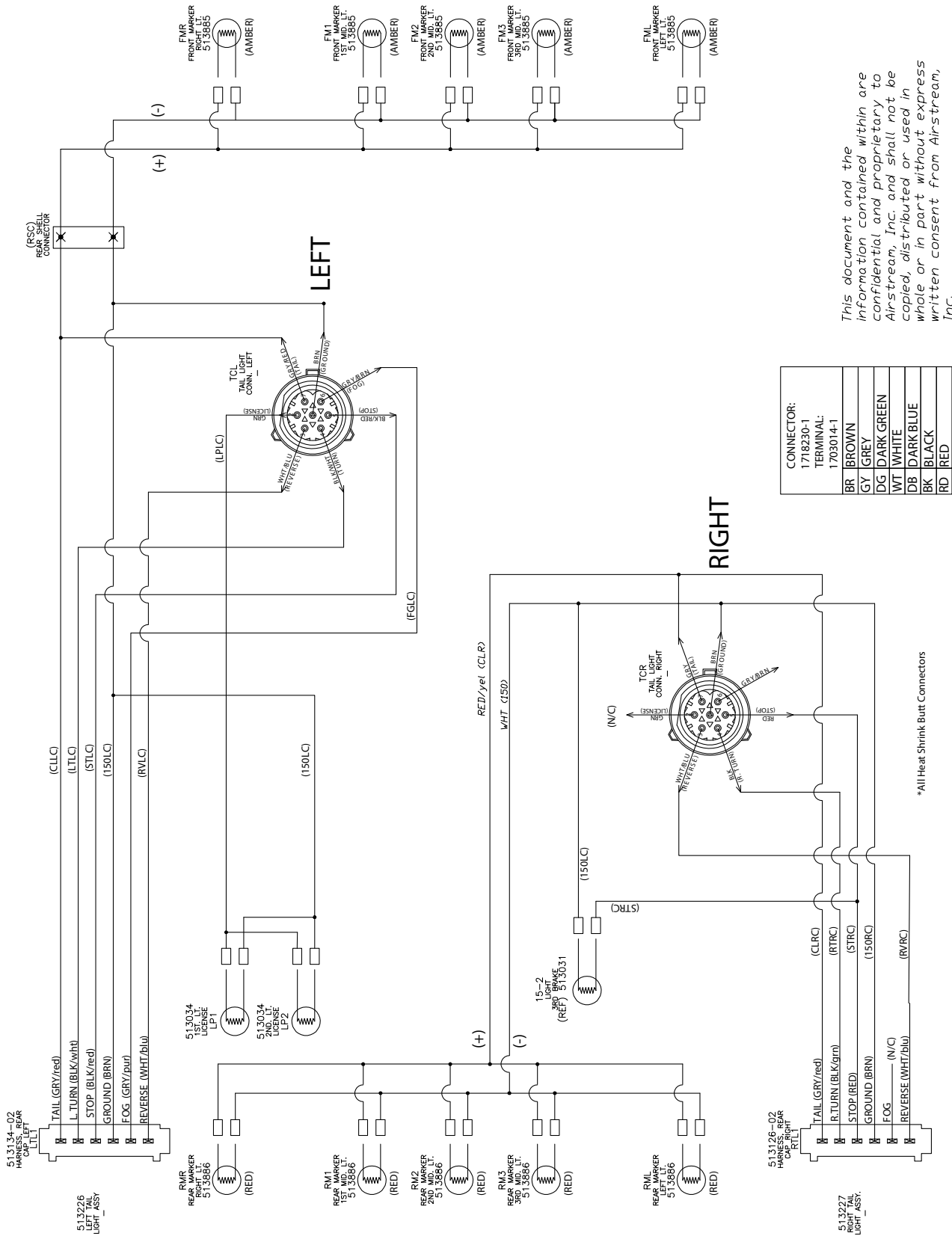

| CONNECTOR: | TERMINAL:  |
|------------|------------|
| 1718230-1  | 1703014-1  |
| BR         | BROWN      |
| GY         | GREY       |
| DG         | DARK GREEN |
| WT         | WHITE      |
| DB         | DARK BLUE  |
| BK         | BLACK      |
| RD         | RED        |

*This document and the information contained within are confidential and proprietary to Airstream, Inc. and shall not be copied, distributed or used in whole or in part without express written consent from Airstream, Inc.*

\*All Heat Shrink Butt Connectors











## 12-Volt Schematic

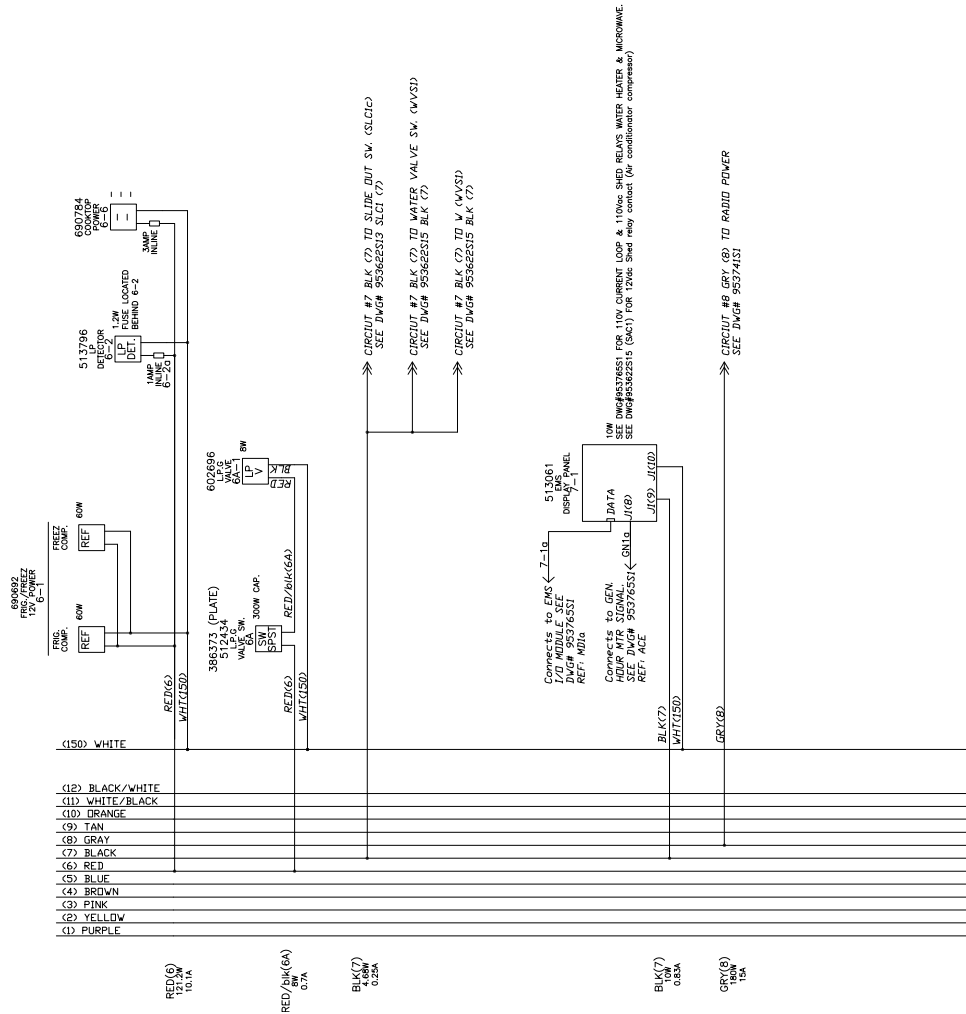

This document and the information contained within are confidential and proprietary to Airstream, Inc. and shall not be copied, distributed or used in whole or in part without express written consent.

\* SCHEMATIC ONLY SHOWS GENERAL WIRE CONNECTIONS NOT ACTUAL WIRE ROUTING. SEE HARNESS DRAWINGS FOR ROUTING.



## 12-Volt Schematic

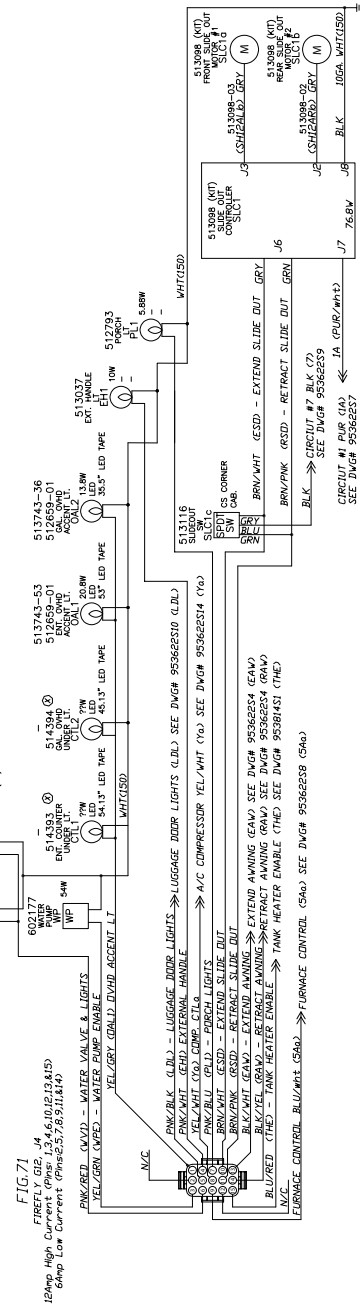
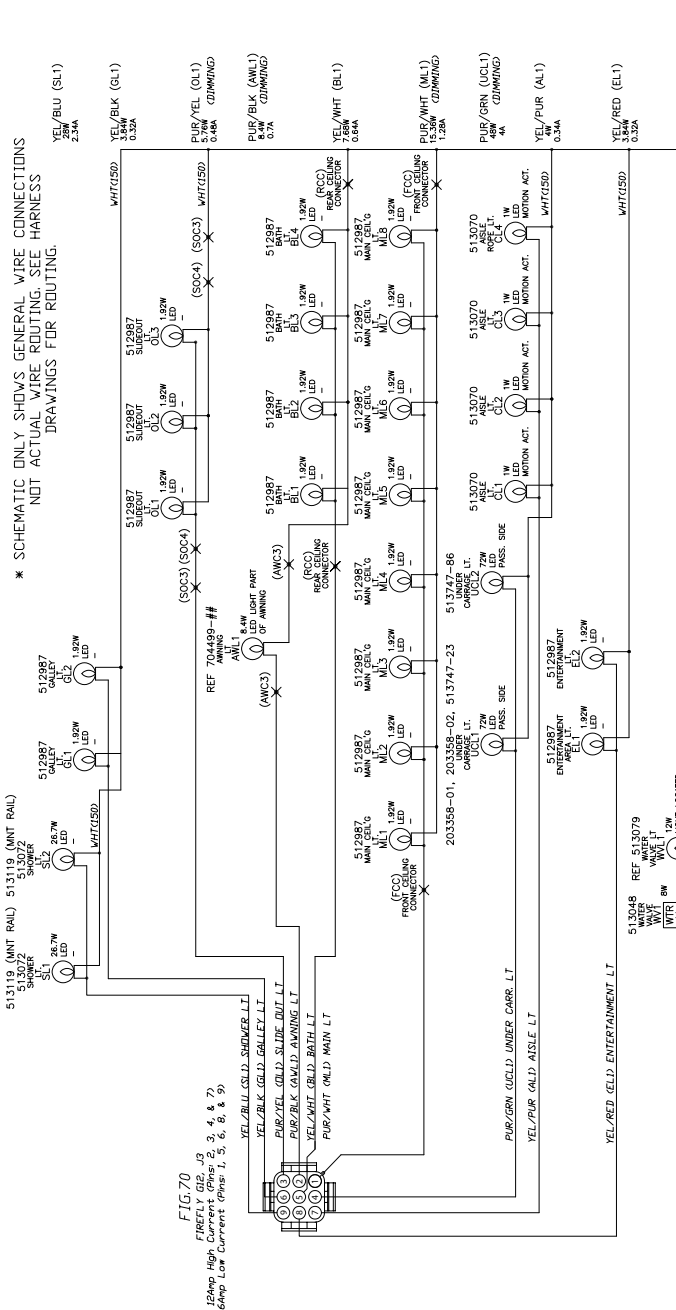

This document and the information contained within are confidential and proprietary to Airstream, Inc. and shall not be copied, distributed or used in whole or in part without express written consent.



## 12-Volt Schematic

FIG 75  
FIREFLY G12, J11

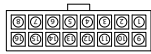

FIG 76  
FIREFLY G12, J12  
THERMISTORS

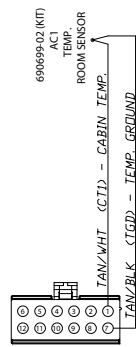
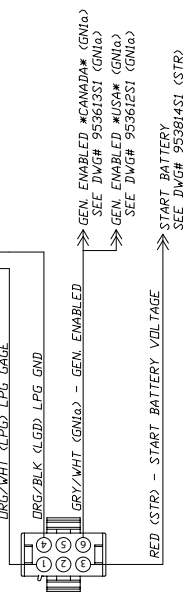

FIG 77  
FIREFLY G12, J13  
LPG



This document and the information contained within are confidential and proprietary to Airstream, Inc. and shall not be copied, distributed or used in whole or in part without express written consent.

\* SCHEMATIC ONLY SHOWS GENERAL WIRE CONNECTIONS NOT ACTUAL WIRE ROUTING. SEE HARNESS DRAWINGS FOR ROUTING.







### Fresh Water Layout

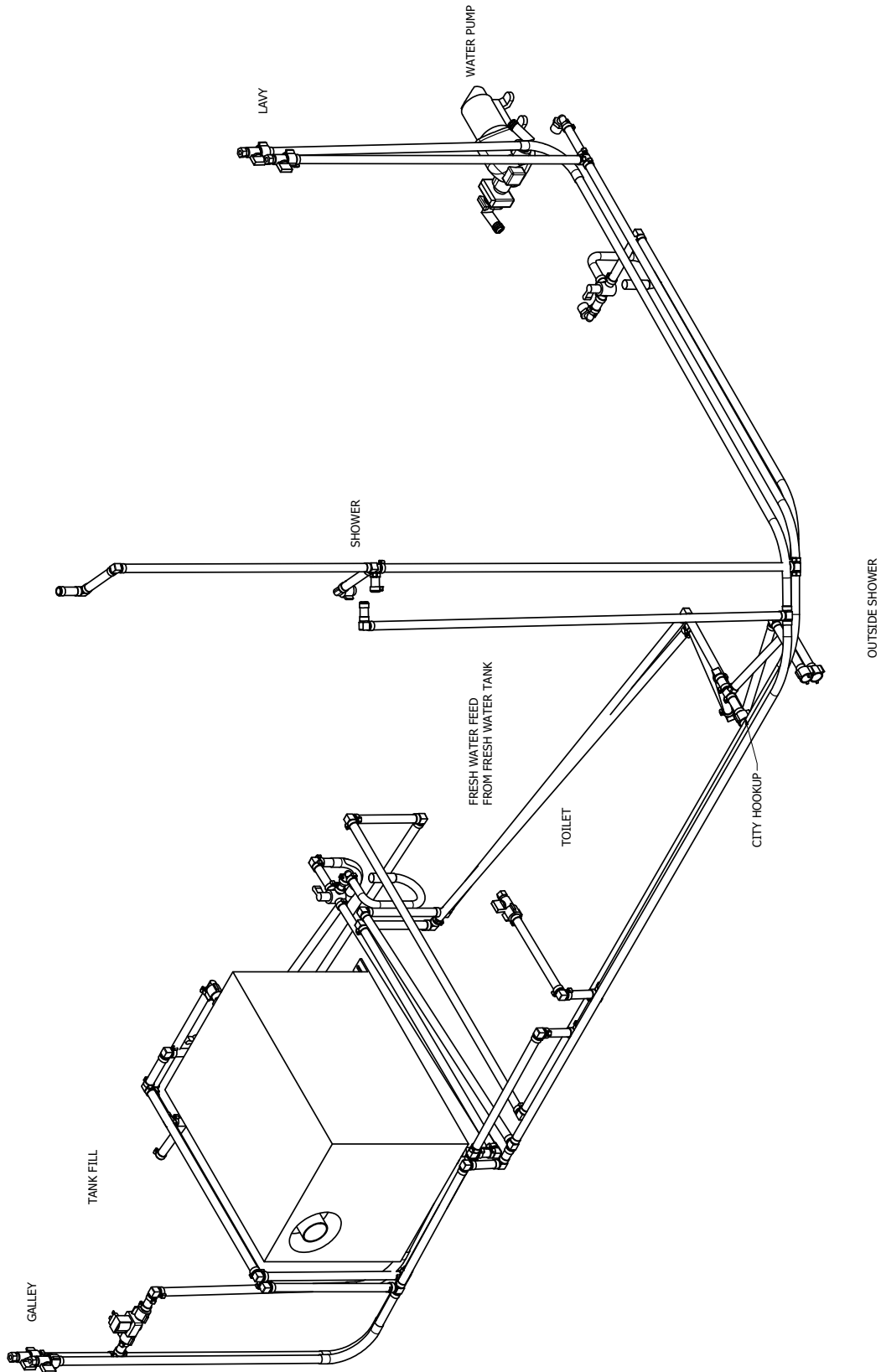

## FAQs and Answers

### Electrical

#### 1. *What should I do to maintain my generator?*

Answer: During the initial break in period, you will need to check your oil every 4 hours during the first 20 hours of operation. Once you reach 20 hours of operation, you will need to change the oil. (Refer to the Onans Owner's manual for more information)

#### 2. *My generator stalls out or quits running if I turn a corner.*

Answer: Make sure you check the oil level. There is a sensor built into the generator that will shut the engine down if it is too low. Turning the corner or stopping quickly while oil is low can cause this to happen. For more information, [see Automatic Generator Start \(AGS\) on page 5-17.](#)

#### 3. *What size batteries are in my Airstream?*

4. Answer: Your Airstream is factory equipped with two 100Ah Battle Born 12V LiFePO4 batteries; [see House Batteries on page 5-14.](#)

#### 5. *My generator will not run properly while I am showing I have 1/4 tank of LPG; however, it runs fine when the tank is showing 1/2 or more.*

Answer: This could be a demand issue. If you are using other appliances, the outside temperature is below 32°F, and the BTU output is lower than at 72°F, the generator will not run properly. This would cause the generator to stall out or run poorly by not creating the proper 120 volts of power.

#### 6. *What is the battery disconnect switch function?*

Answer: The switch is used to eliminate amp draw when the Atlas is not being used or put into storage to preserve battery charge; [see Battery Disconnect Switch on page 5-13.](#)

#### 7. *Do you recommend using a surge protector when plugged into shore power?*

Answer: Your Airstream is breaker protected. However, with the use of more personal electronic devices and the number of motorhome users in parks, added protection is always a plus.

#### 8. *What is my 1000-watt Magnum inverter powering?*

Answer: It is powering the TV and any additional labeled 120-volt receptacles. This plug is designed for no more than 1000 watts combined power, and is intended for charging things such as laptops, phones, and TV usage. Plugging in items such as vacuums, hair dryers, etc. may harm the system; [see Inverter/Charger on page 5-16.](#)

#### 9. *I have an alarm going off at my door.*

Answer: Make sure your step and awnings are completely closed. If either of these are not properly closed, and the engine is running, it will cause the alarm to sound.

### Plumbing

#### 1. *Do I need a water regulator?*

Answer: No, your Airstream is equipped with a built in regulator rated for 50 psi.

#### 2. *How do I get fresh water into my Atlas?*

Answer: You can use the on board fresh water tank and 12-volt pump for your water supply when camping in a remote area, or hook to an external water source via potable water hose to exterior water inlet when parked at a campground; [see City Water Hookup on page 6-7.](#)

#### 3. *What is the difference between a Gray Water tank and the Black Water tank?*

Answer: The Gray Water tank holds water from shower and sink drains. The Black Water tank holds sewer water from the toilet.

#### 4. *Can I run the macerator pump if there is no water going through it?*

Answer: No, it will burn the macerator up if it is run dry for more the 10-30 seconds. Also, you should not run it more than 15 minutes continuously.

#### 5. *How do I use my Black Water tank flush?*

Answer: First, empty your Black Water tank, and then close your Black Water tank valve. Hook up your hose to the external hookup, run water through for a couple minutes, and then open the valve. Turn macerator pump on to empty the tank. Do this a couple times until the tank is clear. (Do not run macerator pump if tank is empty.)

#### 6. *My Gray Water valve will not open while I have the Black Water valve open.*

Answer: True, you can only have one valve open at a time.

## Audio-Video

### 1. *My TV reception is poor. What can I check?*

Answer: Verify if your antenna booster is set to proper selection (On- for antenna and Off- for cable satellite). You should also make sure connections are tight on your TV; [see TV/Radio Antenna on page 5-22](#)

### 2. *Will my TV and DVD player (user provided) operate while traveling down the highway?*

Answer: Yes, if you have your inverter turned on, the TV will operate; [see Inverter/Charger on page 5-16](#).

### 3. *Does the TV play through the dash stereo?*

Answer: No, the TV's audio is not connected to the dash radio.

## Chassis

### 1. *Where is my spare tire located?*

Answer: The Atlas is not equipped with a spare tire or carrier. However, Coach-Net 24/7 roadside assistance has been provided to you for the first two years under the warranty. Owner's will need to re-enroll after the initial two year warranty has expired.

### 2. *How do I jack the Atlas up to change a tire?*

Answer: Please refer to the Mercedes owner's manual.

### 3. *Where can I find my Atlas' serial number?*

Answer: A label is attached on the driver's side B-pillar or the passenger's door. This label will also provide the inflation pressure of the tires and weight specifications.

## Appliances

### 1. *I am planning for a trip in my Airstream. How should I get the refrigerator cooled down?*

Answer: Turn the power on and set the thermostat between 3 and 4. You can make further adjustments to suit your personal requirements after the box has cooled down. Allow the refrigerator to come down to temperature before loading with product. Setting the thermostat to a higher setting, e.g. 7, will not decrease the time required for the unit to cool down to its normal operating temperature. AC/DC units cool at the same rate on DC as on AC. Normal refrigerator operating temperatures are 34°F to 40°F.

### 2. *My air conditioner freezes up. What is the problem?*

Answer: In high humidity conditions, the manufacturer recommends you operate your AC on the high fan setting and all vents should be open to have maximum air flow over the coils; this helps reduce icing. Also, dirty AC filters can restrict air flow and cause the AC to ice up.

## Maintenance

### 1. *Can I have my awning out with heavy winds?*

Answer: No this may cause damage if it is too windy. However, the awning does have a built in sensor that will automatically retract the awning.

### 2. *I want to clean the exterior of my Airstream. What do you suggest?*

Answer: Airstream recommends washing the Atlas using a mild, auto detergent, safe for clear coated surfaces. Airstream recommends washing based on operating conditions, and waxing a minimum of twice a year. Any automotive wax designed specifically for clear coated surfaces will provides good wax protection; [see Exterior Care on page 6-2](#).



## Index

### A

Air Conditioner 5-24  
Air Ride Suspension 7-10  
Airstream Academy ii  
Alarms and Detectors 2-3  
Alternator 5-19  
Antennas  
    Satellite Antenna 5-22  
    TV/Radio Antenna 5-22  
Appliances 2-2, 5-24  
Automatic Generator Start (AGS)  
    5-17  
Awning 6-10

### B

Batteries 5-14  
Battery Disconnect Switch 5-13  
Battery Management System  
    (BMS) 5-14  
Bed 5-6  
Black Water Tank Flush 9-12  
Bluetooth App 5-21  
Brake Controller 8-7

### C

Cabinets 5-7  
Cable/Satellite Connection 5-22  
Camping 3-7  
    Effects of Prolonged Occupancy  
        3-9  
    Longer Trips 3-8  
    Overnight Stop 3-8  
Carbon Monoxide 2-5  
Carbon Monoxide (CO) Detector  
    2-6  
Carbon Monoxide Detector 2-3  
Carbon Monoxide Poisoning 2-5  
Carefree Connects 6-10  
Charger 5-16  
Chemical Sensitivity 2-2  
Circuit breakers 5-9  
    GFCI breakers 5-10  
City Power 5-11  
City Water Hookup 6-7  
Cleaning  
    Exterior 6-2  
    Interior 5-3  
Coach-Net 3-6  
Cooktop 5-25  
Cordset 6-8

### D

Detectors 2-3  
Door 6-9  
    Lubrication and Adjustment 9-16  
Doormat and Rug Selection 5-4  
Doors 6-9  
Drain and Waste System 9-10  
Drain System 3-10

### E

Electrical Diagrams 9-17  
Electrical System  
    Electrical System Operation 5-13  
Emergency Exits 2-9  
EMS 5-11  
Energy Management System 5-11  
Energy Management System  
    (EMS)  
    Display Panel 5-11  
Entertainment Systems 5-22  
Exterior Care 6-2  
Exterior Components 6-4

### F

Fan 5-25  
FAQs and Answers 9-32  
Faucets 5-5  
Fire Extinguisher 2-9  
Firefly 5-20  
Floor 5-4  
Floor Plans 4-2  
Formaldehyde 2-2  
Fresh Water Layout 9-31  
Fuels and Operating Fluids 7-2  
Furnace 5-26  
Fuse Locations 5-10

### G

Generator 5-16, 5-19  
GFCI 5-10  
Gross Axle Weight Rating (GAWR)  
    4-4  
Gross Combined Vehicle Weight  
    Rating (GCWR) 4-4  
Gross Vehicular Weight Rating  
    (GVWR) 4-4

### H

Heated Tanks 3-11  
Heat Pump 5-24  
Hitch 8-4  
    Hitch Cover 6-12  
Hydraulic Leveling System 6-11

### I

Inverter/Charger 5-16

### J

Jack 7-7

### L

Labels 4-4  
Leveling System 6-11  
Lighting 5-21  
Loading 8-2  
LPG 9-6  
    Detector 2-6  
    Exterior LP Port 9-7  
    LPG Safety Information 2-7  
LPG and Carbon Monoxide Detec-  
    tor 2-6  
LPG System 9-6  
    Regulator 9-6  
    Remote Fill 9-6  
Lug Nut Tightening 7-8

### M

Macerator Pump 9-10  
    Winterizing 9-15  
Maintenance Schedule 9-2  
Manufacturer's Certification Label  
    4-4  
Mercedes me Connect App 7-2  
Microwave Ovens 5-26  
Mira 5-21  
Molds 2-2, 3-10  
Monitor Panel 5-20  
Multiplex System 5-19, 5-20  
    Bluetooth App 5-21  
Murphy Bed 5-6

### O

Occupant and Cargo Carrying  
    Capacity Label 4-4  
Outlets 5-11

### P

Plumbing 9-7  
Power Center 5-9  
Power Inlet and Cordset 6-8  
Power Shades 5-8

# Index

---

## R

Refrigerator/Freezer 5-26  
Roadside Assistance 3-6  
Roof Lockers 5-7  
Rug Selection 5-4

## S

Safety 2-2, 8-4  
Sanitizing 9-9  
Satellite Connection 5-22  
Screen Door 6-9  
Seat belts 8-4  
Service 3-6  
Shades 5-8  
Shoreline Connection 5-18  
Shoreline power 5-11  
Shoreline Power Supply 6-8  
Shower, Exterior 6-6  
Shower, Interior 5-4  
Slide-Out Room 5-7  
SmartPlug 5-11, 5-18  
    Cordset 6-8  
    Inlet 6-8  
Smoke Alarm 2-3  
    Maintenance of Smoke/CO Detector 2-6  
Smoke/CO Detector 2-6  
Sofa 5-6  
Solar Panel 5-12  
Solar System 5-12  
Specifications 4-3  
    Specification Tags 4-4  
Starlink 5-23  
Step 6-7  
Storage 9-16  
Strainer 9-8  
Sun Shades 5-4

## T

Tables 5-8  
Tail Lights 6-9  
Tank heaters 3-11  
Temperature Limits 5-15  
Tire and Loading Placard 4-4  
Tire Care  
    Inflation Pressure 4-3  
    Tire Size 4-3  
Tires  
    Care 9-5  
    Changing 7-6  
    Rotation 7-9  
Toilet 5-4  
    Winterizing 9-15  
Torque Value 4-3  
Towing 8-6  
    Backing Up 8-8  
    Hitch 8-4  
    Towing a Boat 8-6  
    Trailer 8-4  
    Your Touring Coach 8-9  
TV Operation 5-22

## U

Unloaded Vehicle Weight (UVW) 4-4  
User Guide Videos ii  
Utility Compartment Doors 6-9

## V

Vehicle Storage 9-16  
Vent Fan 5-25  
Ventilation 2-2, 2-3  
Videos ii  
Vinyl Floor 5-4

## W

Warranty 3-2  
Waste Water System 3-10  
Water Heater 5-27  
    Control Center 5-27  
    Winterizing 9-14  
Water Pump 9-8  
Water Pump and Strainer 9-8  
Water System 9-7  
Weighing 8-2  
Weight Distribution 8-3  
Wheel Bolt/Lug Nut Tightening 7-8  
Wi-Fi 5-23  
Windows 6-6  
Winterizing and Storage 9-12  
Winter Traveling 3-11





# **AIRSTREAM<sup>®</sup>**

1001 West Pike Street

P.O. Box 629

Jackson Center, OH. 45334-0629

Phone: (937) 596-6111 Fax: (937) 596-7939

[www.airstream.com](http://www.airstream.com)