

# AIRSTREAM®



SCAN ME

2025 Rangeline

# RANGELINE®

Owner's Manual

## User Guide Videos and Airstream Academy

Scan the QR code on the cover or visit <https://support.airstream.com> to view model-specific User Guide Videos that explore topics discussed in this manual. Visit Airstream Academy at <https://www.airstream.com/academy/> to learn the ins and outs of Airstreaming by exploring videos, articles, and frequently asked questions covering a wide range of popular RV topics.

### **⚠ WARNING**

**Operating, servicing and maintaining a passenger vehicle or off-road vehicle can expose you to chemicals including engine exhaust, carbon monoxide, phthalates, and lead, which are known to the State of California to cause cancer and birth defects or other reproductive harm. To minimize exposure, avoid breathing exhaust, do not idle the engine except as necessary, service your vehicle in a well-ventilated area and wear gloves or wash your hands frequently when servicing your vehicle. For more information go to [www.P65Warnings.ca.gov/passenger-vehicle](http://www.P65Warnings.ca.gov/passenger-vehicle)**

## Disclaimer And Copyright

All information, illustrations and specifications contained in this manual are based on the latest product information available at the time of publication approval. If and when new materials and production techniques are developed that can improve the quality of its product, or material substitutions are necessary due to availability, Airstream reserves the right to make such changes.

Airstream Rangeline Owner's Manual

©2024 Airstream, Inc. All rights reserved

**Publication Date: September 2024**

**REV# 01**

# AIRSTREAM®

## TABLE OF CONTENTS

INTRODUCTION . . . . .	1-1	RAM PROMASTER VAN . . . . .	7-1
SAFETY . . . . .	2-1	Important ProMaster Information . . . . .	7-2
Safety Precautions . . . . .	2-2	Component Identification . . . . .	7-2
Chemical Sensitivity and Ventilation . . . . .	2-2	Tires . . . . .	7-3
Alarms and Detectors . . . . .	2-4	Changing a Tire . . . . .	7-6
Fire Extinguisher . . . . .	2-7	Installing and Removing A Wheel . . . . .	7-8
Emergency Exit. . . . .	2-8	Tire Rotation . . . . .	7-9
GENERAL INFORMATION . . . . .	3-1	DRIVING . . . . .	8-1
Limited Warranty Policy . . . . .	3-2	Loading . . . . .	8-2
Service . . . . .	3-6	Safety . . . . .	8-4
Camping . . . . .	3-7	Trailer Towing and Driving Tips . . . . .	8-5
FLOOR PLANS AND SPECIFICATIONS . . . . .	4-1	Towing Your Touring Coach . . . . .	8-10
Floor Plan . . . . .	4-2	Safety Check List . . . . .	8-10
Specifications . . . . .	4-3	MAINTENANCE . . . . .	9-1
INTERIOR . . . . .	5-1	Maintenance Schedule . . . . .	9-2
General Information and Cleaning . . . . .	5-3	Suggested Maintenance and Replacement Parts . . . . .	9-3
Electrical System Overview . . . . .	5-11	Tire Care . . . . .	9-5
Electrical System Operation . . . . .	5-15	Plumbing . . . . .	9-6
Entertainment Systems. . . . .	5-23	Drain and Waste System . . . . .	9-8
Appliances . . . . .	5-24	Winterizing and Storage . . . . .	9-10
EXTERIOR . . . . .	6-1	Electrical Diagrams . . . . .	9-13
Exterior Care. . . . .	6-2	Fresh Water Layout . . . . .	9-22
Roadside Exterior Components . . . . .	6-4	FAQs and Answers . . . . .	9-23
Curbside Exterior Components. . . . .	6-5		
Exterior Features . . . . .	6-6		
Awning . . . . .	6-8		
Screen Doors . . . . .	6-9		



# AIRSTREAM®

## Section 1 INTRODUCTION

The Owner's Manual for your new Airstream Touring Coach answers the most frequent inquiries regarding the operation, function, and care of the many systems that make modern motorhoming a joy.

The Ram ProMaster Van, upon which Airstream builds the Rangeline, is manufactured by Ram. The operation of the ProMaster van, its engine, power train, and other related components are in the Ram ProMaster Owner's Manual and other literature provided by Ram. Ram or their suppliers warranty those systems discussed in the ProMaster literature.

Airstream realizes our customers possess varying degrees of expertise in maintaining and repairing components of their touring coach. For this reason, the service and troubleshooting information found in this manual is for those with average mechanical skills. We also realize you may be more familiar with one area than another. Only you know your capabilities and limitations. We want you to use this manual and hope you will find the information helpful; however, if you ever feel help is needed, please get in touch with your dealer.

All information, illustrations, and specifications in this manual are based on the latest product information available at publication approval. Airstream reserves the right to make changes if and when new materials and production techniques are developed that can improve the quality of its product or when material substitutions are necessary due to availability.

We have provided many important safety messages in this manual. Always read and obey all safety messages.

Optional items may be available on all or particular models. Additionally, some optional items can only be included during the manufacturing phase and cannot be added aftermarket. The inclusion of optional items information in this manual does not imply or suggest the availability, application, suitability, or inclusion for any specific unit.

### NOTE

**Your Ram ProMaster Van Owner's Manual and Warranty contain important cautions, warnings, operational, and warranty information on the ProMaster and its components. All information in the ProMaster manual should be reviewed and followed for your safety. The Airstream Owner's Manual may provide additional information and tips on the use of the van as a touring coach; however, no information in the Airstream manual should be interpreted as advice or directions to disregard or void the warnings, cautions, or other information contained in the Ram ProMaster manual.**

Airstream uses the  safety alert symbol and signal words Danger, Warning, and Caution to alert you to potential personal injury hazards. Obey all safety messages that follow this symbol to avoid possible injury or death. The following are examples of each type of signal word, safety message, and information message found throughout this manual.

## **DANGER**

Indicates a hazardous situation which, if not avoided, will result in death or serious injury.

## **WARNING**

Indicates a hazardous situation which, if not avoided, could result in death or serious injury.

## **CAUTION**

Indicates a hazardous situation which, if not avoided, could result in minor or moderate injury.

## **NOTICE**

Indicates a potential situation which, if not avoided, may result in damage to your Airstream. Addresses practices not related to personal injury.

## **NOTE**

Provides noteworthy information and tips about your Airstream.

# AIRSTREAM®

## Section 2 SAFETY

SAFETY PRECAUTIONS . . . . .	2-2	ALARMS AND DETECTORS . . . . .	2-4
Weight Distribution . . . . .	2-2	Smoke/Carbon Monoxide Alarm/Detector . . . . .	2-4
Electrical Appliances and Outlets . . . . .	2-2	Smoke Alarm Indicators . . . . .	2-4
Generator and Hydronic System Safety . . . . .	2-2	Carbon Monoxide Alarm Indicators . . . . .	2-4
Mold . . . . .	2-2	Batteries Low . . . . .	2-4
CHEMICAL SENSITIVITY AND VENTILATION . . . . .	2-2	Regular Maintenance of Smoke/CO Detector . . . . .	2-5
Chemical Sensitivity . . . . .	2-2	Testing the Smoke/CO Detector . . . . .	2-5
Formaldehyde . . . . .	2-3	This Carbon Monoxide Detector Is Not . . . . .	2-5
Ventilation . . . . .	2-3	Important Safety Precautions . . . . .	2-5
Do Not Smoke . . . . .	2-3	What Is Carbon Monoxide . . . . .	2-6
Medical Advice . . . . .	2-3	Conditions that can result in potentially dangerous CO situations . . . . .	2-6
		Symptoms of Carbon Monoxide Poisoning . . . . .	2-6
		Gasoline Powered Generator and Hydronic System Safety Information . . . . .	2-7
		FIRE EXTINGUISHER . . . . .	2-7
		EMERGENCY EXIT . . . . .	2-8
		Sliding Door and Rear Door Emergency Exit . . . . .	2-8
		Safety . . . . .	2-8

## Safety Precautions

When considering safety matters, it is best to exercise prudence. If you are careless with matches, cigarettes, flammable material, or any other hazardous material, you surely realize your potential for accidents increases. You will find many safety recommendations in this section and throughout the manual. The following recommendations are the ones we consider to be the most important.

### Weight Distribution

Touring coaches have fresh, gray, and black water tanks and multiple storage areas. It gives you great flexibility in loading. If you want to load down all the storage compartments, you may need to reduce the volume of fluids you carry. Distribute your additional cargo as evenly as possible with the heaviest objects located as low as possible. For detailed information on loading and weight distribution, [see Loading on page 8-2](#).

### Tire Safety

Properly maintained tires improve your vehicle's steering, stopping, traction, and load-carrying capability. Read the Tire Safety information included in your Ram ProMaster Owner's Manual. Also, [see Tire Care on page 9-5](#).

### Electrical Appliances and Outlets

Improper handling of electrical components can be fatal. Do not touch or use electrical components or appliances with bare feet, while hands or feet are wet, or while standing in water or on damp ground.

### Generator and Hydronic System Safety

Do not operate the generator or hydronic heating and hot water system in an enclosed building or a partly enclosed area, such as a garage. Follow all instructions and warnings in this manual and the generator manufacturer's manual. For more information, [see Generator on page 5-17](#).

### Mold

Mold and mold spores exist throughout indoor and outdoor environments. There is no practical way to eliminate all mold and mold spores in the indoor environment; however, the way to control indoor mold growth is to manage moisture and humidity levels; [see What factors contribute to mold growth on page 3-9](#).

## Chemical Sensitivity and Ventilation

### Chemical Sensitivity

Immediately after purchasing your new recreational vehicle and after it has been closed up for an extended period, you may notice a strong odor and experience a chemical sensitivity. This odor is not a defect in your recreational vehicle. Like your home, many different products are used in the construction of recreational vehicles, such as carpet, linoleum, plywood, insulation, upholstery, etc. Formaldehyde is also the by-product of combustion and numerous household products, such as paints, coatings, and cosmetics. However, recreational vehicles are much smaller than your home; therefore, the air exchange inside a recreational vehicle is significantly less than in a home. When new or exposed to elevated temperatures and humidity, these products may off-gas different chemicals, including formaldehyde. This off-gassing, in combination with minimal air exchange, may cause you to experience irritation of the eyes, nose, and throat, as well as sometimes headache, nausea, and a variety of asthma-like symptoms. Elderly persons and young children, as well as anyone with a history of asthma, allergies, or lung problems, may be more susceptible to the effects of off-gassing.



**Formaldehyde**

Formaldehyde is a naturally occurring substance and is an important chemical used widely by industries to manufacture building materials and numerous household products. It is also a by-product of combustion and certain other natural processes. Thus, it may be present inside the touring coach. Ventilation of the unit typically reduces the exposure to a comfortable level.

Trace levels of formaldehyde are released from smoking, cooking, using soaps and detergents, such as carpet shampoos and cosmetics, and many other household products. Some people are very sensitive to formaldehyde, while others may not have any reaction to the same levels of formaldehyde. Amounts released decrease over time.

Your Airstream touring coach utilizes low formaldehyde-emitting (LFE) wood products, which is typical in the recreation vehicle industry. Formaldehyde is an essential component of the adhesives that bind wood products used in recreation vehicles. The wood products in your coach are designed to emit formaldehyde at or below industry guidelines and should not produce symptoms in most individuals.

While LFE wood products typically do not emit formaldehyde at a level that would cause symptoms in most individuals, it is possible, though not likely, for symptoms to occur when the touring coach is improperly ventilated. Ventilation is an essential requirement for touring coach use for many reasons. You can greatly reduce formaldehyde's effects by opening windows, roof vents, running the air conditioner, or some combination thereof. In addition, the emission of formaldehyde by these products naturally decreases rapidly over time.

Airstream strongly suggests you take measures to ventilate your touring coach regularly. If you have any questions concerning the proper ventilation of your touring coach, please do not hesitate to contact your dealer or Airstream.

**Ventilation**

To reduce or lessen exposure to chemicals from off-gassing, it is of the utmost importance that you ventilate your recreational vehicle. Ventilation should frequently occur after purchase, and elevated temperatures and humidity occur. Heat and humidity accelerate off-gassing; open windows, exhaust vents, and doors. Force out stale air and draw fresh air in by operating vent fans and roof AC. Decreasing airflow by sealing the recreational vehicle increases the formaldehyde level in the vehicle's indoor air.

**Do Not Smoke**

It is recommended you do not smoke inside your recreational vehicle. In addition to causing damage to your recreational vehicle, tobacco smoke releases formaldehyde and other toxic chemicals.

**Medical Advice**

Questions regarding the effects of formaldehyde on your health should be submitted to your doctor or local health department.

## Alarms and Detectors

Parts of this section on the combination Smoke/Carbon Monoxide Detector are a reprint of the manual included with the device and provided to you in the Airstream owner's packet.

Carefully read and understand the contents of the provided instruction manual before using the detector. Store the manual in a safe place for future reference. Pay particular attention to the safety warnings. Pass the manual on to any subsequent users of the alarm.

If you have not received the manual, contact your dealership to obtain one, contact Airstream Customer Relations at 937-596-6111, or visit <https://www.firstalert.com> for support.

### **⚠ WARNING**

Dangers, Warnings, and Cautions alert you to important operating instructions or to potentially hazardous situations. Pay special attention to these items.

### Smoke/Carbon Monoxide Alarm/Detector



#### Smoke Alarm Indicators

Power/Smoke LED: Flashes RED

Horn: 3 BEEPS, pause, 3 BEEPS, pause

CO LED: OFF

#### Carbon Monoxide Alarm Indicators

CO LED: Flashes RED

Horn: 4 BEEPS, pause, 4 BEEPS, pause

Power/Smoke LED: OFF

### **⚠ WARNING**

If either alarm sounds, exit immediately and call the Fire Department. In the event of a carbon monoxide alarm, exit immediately and move everyone to a source of fresh air. Do not remove the batteries.

### **⚠ WARNING**

The Smoke/CO detector is shipped with batteries deactivated. Ask your dealer to activate batteries or activate batteries immediately upon delivery. Failure to follow this warning will remove your protection.

### **⚠ WARNING**

This product is intended for use in ordinary, indoor locations of family living units. It is not designed to measure compliance with occupational safety and health administration (OSHA) commercial or industrial standards. Individuals who are at special risk from Carbon Monoxide exposure by reason of age, pregnancy, or medical condition may consider using warning devices which provide audible and visual signals for Carbon Monoxide concentration under 30 ppm. If in doubt, consult your medical practitioner.

#### Batteries Low

The Smoke/Carbon Monoxide Detector will chirp once a minute for at least 30 days when the batteries are weak. Replace the batteries immediately and only use new batteries. The unit may momentarily beep when you install the batteries. The GREEN light will flash about every 60 seconds when the unit has battery power.

### **⚠ WARNING**

The battery door will resist closing until batteries are installed. This warns you that the unit will not operate without batteries.

### **⚠ WARNING**

Smoke/Carbon Monoxide detectors have a limited life. The unit should be replaced immediately if it is not operating properly. You should always replace an alarm after 5 years from the date of purchase. Write the purchase date on the space provided on the back of unit.

**Regular Maintenance of Smoke/CO Detector**

The Smoke/CO detector has been designed to be as maintenance-free as possible, but there are a few simple things you must do to keep it working properly. Use replacement batteries as indicated in the manual included with the device and provided to you in the Airstream owner’s packet. The unit may not operate properly with other batteries. Never use rechargeable batteries since they may not provide a constant charge.

**Testing the Smoke/CO Detector**

Test it at least once a week. PRESS and HOLD the TEST/SILENCE button 3-5 seconds until the unit starts to alarm. During testing, you will see and hear the following sequence:

- The Horn will sound 3 BEEPS, pause, 3 BEEPS. The Power/Smoke LED flashes Red and the CO LED will be OFF.
- Next the Horn will sound 4 BEEPS, pause, 4 BEEPS. The Power/Smoke LED will be OFF and the CO LED flashes Red.

Clean the Smoke/CO Alarm at least once a month: gently vacuum the outside of the alarm using your household vacuum’s soft brush attachment or use a can of compressed air to clear away dust and debris (sold at computer or office supply stores). Follow manufacturer instructions for use. Never use water, cleaners, or solvents since they may damage the unit.

If the alarm becomes contaminated by excessive dust or debris causing unwanted alarms, replace the unit immediately.

**⚠ WARNING**

**Test Units in your touring coach after the vehicle has been in storage, before each trip, and at least once a week while in use. If the alarm ever fails to test correctly, have it replaced immediately. If the alarm is not working properly, it cannot alert you to a problem. Failure to test units used in RVs as described may remove your protection.**

***This Carbon Monoxide Detector Is Not***

- Designed to detect any gas other than Carbon Monoxide.
- To be seen as a substitute for the proper servicing of fuel-burning appliances.
- To be used on an intermittent basis, or as a portable alarm for spillage of combustion products from fuel-burning appliances.

**⚠ WARNING**

**This Carbon Monoxide detector is designed for indoor use only. Do not expose to rain or moisture. Do not knock or drop the alarm. Do not open or tamper with the alarm as this could cause malfunction. The detector will not protect against the risk of Carbon Monoxide poisoning when the batteries are dead or missing. The alarm will only indicate the presence of Carbon Monoxide gas at the sensor. Carbon Monoxide gas may be present in other areas.**

**Important Safety Precautions**

- Ideally, it is recommended that a Carbon Monoxide detector should be installed in or near every room that has a fuel burning appliance such as any room heaters, water heaters, cookers, grills, etc.
- Ensure that the alarm horn can be heard by all those who are intended to hear it. Seek medical help if it is suspected that a user of the RV is suffering from Carbon Monoxide poisoning.
- If the alarm sounds, make sure to investigate the problem. Ignoring the alarm may result in sickness, injury or death. (CO may be present even if nothing is seen or smelled by the user.)
- Room spaces should be well ventilated when household cleaning supplies are used as these may cause a false alarm.
- Alarm should be tested once per week. If further details are required, which do not appear in this manual, visit <https://www.firstalert.com> for support.

**⚠ WARNING**

**Activation of your Carbon Monoxide alarm’s audible horn indicates the presence of Carbon Monoxide that can kill you. Leave the area immediately!**

## What Is Carbon Monoxide

Carbon Monoxide (CO) is a highly poisonous gas released when fuels burn. Your generator and vehicle engine both produce carbon monoxide. It is invisible, has no smell, and is very difficult to detect with the human senses. Under normal conditions, the amount of CO drifting in from outside or potentially from under the vehicle is not dangerous in a room correctly ventilated room provided you take precautions when parking the coach. CO is a real danger in air-tight vehicles with added insulation, sealed windows, and other weatherproofing that can trap CO inside; [see Gasoline Powered Generator and Hydronic System Safety Information on page 2-7](#).

Keep in mind that carbon monoxide can come from many different fuel sources. These fuels include wood, coal, charcoal, oil, natural gas, gasoline, kerosene, and propane. Aftermarket small LP gas appliances and grills are often sources of CO. If they are not properly maintained, are improperly ventilated, or malfunction, CO levels can rise quickly.

### **Conditions that can result in potentially dangerous CO situations**

1. Excessive spillage or reverse-venting of fuel-burning generators and appliances caused by outdoor conditions, such as:
  - Wind direction and/or velocity, including high gusts of wind.
  - Heavy air in the vent pipes (cold/humid air with extended periods between cycles).
  - Negative pressure differential resulting from use of exhaust fans.
  - Simultaneous operation of several fuel-burning appliances competing for limited internal air.
  - Exhaust connections vibrating loose
  - Obstructions in or unconventional vent-pipe designs which can amplify the above situations.
2. Extended use of un-vented fuel burning devices.
3. Temperature increase that can trap exhaust gases near the ground.

## Symptoms of Carbon Monoxide Poisoning

- Mild Exposure - Slight headache, nausea, vomiting, fatigue (flu-like symptoms).
- Medium Exposure - Throbbing headache, drowsiness, confusion, fast heart rate.
- Extreme Exposure - Convulsions, unconsciousness, heart and lung failure. Exposure to CO can cause brain damage and/or death.

### **⚠ DANGER**

**Many causes of reported CARBON MONOXIDE POISONING indicate that while victims are aware that they are not well, they become so disoriented that they are unable to save themselves by either exiting the area or calling for assistance. Also young children and pets may be the first to be affected.**

### **⚠ DANGER**

**Carbon Monoxide is poisonous and can cause confusion, unconsciousness, and death. Follow all instructions, cautions, and warnings in this section.**

### **⚠ WARNING**

**NEVER ignore any alarm. Failure to respond can result in injury or death. The Silence Features are for your convenience only and will not correct a problem. Always check your touring coach for a potential problem after any alarm. Failure to do so can result in injury or death.**

**Gasoline Powered Generator and Hydronic System Safety Information**

1. Never sleep in the vehicle with the generator or heating and hot water system running without ensuring the Carbon Monoxide detector is working. Primary protection against inhaling Carbon Monoxide is daily (every eight hour) inspection for visible and audible generator or heating and hot water exhaust system leaks.
2. DO NOT operate the generator or heating and hot water system in an enclosed building or in a partly enclosed area such as a garage.
3. Review the safety precautions for fuel and exhaust fumes in the generator and heating and hot water system manuals.
4. DO NOT operate the generator or heating and hot water system when the recreation vehicle is parked in high grass or brush. Heat from the exhaust could cause a fire in dry conditions.
5. DO NOT simultaneously operate generator or heating and hot water system and a ventilator which could result in the entry of exhaust gas into the interior. When exhaust ventilators are used, we recommend that a window on the opposite side of the unit “upwind” of exhaust gases be opened to provide cross ventilation.
6. When parked, orient the vehicle so that the wind will carry the exhaust away from the vehicle.
7. DO NOT open nearby windows, ventilators, or doors into the passenger compartment, particularly those which can be “down wind”, even part of the time.
8. DO NOT operate the generator or heating and hot water system when parked in close proximity to vegetation, snow, buildings, vehicles, or any other object that could deflect the exhaust under or into the vehicle.
9. DO NOT touch the generator or heating and hot water system or their exhaust pipes when running, or immediately after shutting off. Heat from the generator and heating and hot water system can cause burns. Allow them to cool before attempting maintenance or service.

**⚠ DANGER**

**Your Touring Coach is equipped with an Automatic Generator Start System and a cycling heating and hot water system. When set or engaged to run, exposure to carbon monoxide, moving parts, and electricity hazards are possible due to unexpected automatic starting.**

**Fire Extinguisher**



The fire extinguisher should be checked for charge on a regular basis. It is located near the side door entrance by the passenger seat. Make sure your family knows how to release the extinguisher storage bracket and how to properly operate the extinguisher. Check with your local fire department for professional advice on its operation and use if you find the directions on the extinguisher unclear. They will be able and willing to assist you and your family.

**⚠ WARNING**

**Read the directions carefully on the fire extinguisher. If there is any doubt on the operation you and your family should practice, then replace or recharge the extinguisher. You will find your local fire department will be happy to assist you and answer any questions.**

**⚠ WARNING**

**Do not smoke inside the touring coach. Keep matches out of reach of small children. Do not bring flammable liquids inside the RV or clean with flammable materials. Keep flammable material away from open flame. We have all heard these warnings many times, but they are still among the leading causes of fires.**

# Safety

---

## Emergency Exit

There are four avenues of escape from the touring coach in the event of an emergency: the driver's door, the passenger door, the sliding door, and the rear doors.

## Sliding Door and Rear Door Emergency Exit

Both the sliding side door and rear door allow quick escape from locked doors in an emergency.

**PULL** either door latch **TWICE** to open

Rear Screen Door - **PUSH** to open in an emergency.

It is held in place at the edges by magnets.



## Safety

As always, safety should be a top priority. Ensure that you, and everyone traveling with you, can quickly operate the main door and rear doors in the dark. Plan for other means of escape in case these designated exits are blocked. A little planning and a quick practice session at each camping site is well worth the time it may take.

## **⚠ WARNING**

**Do not block access to the doors from the inside or outside of the vehicle. At each campsite, make sure you have not parked in such a manner as to block the operation of the doors or the escape avenues by being too close to trees, fences, or other impediments. Consider that bike racks and other rear-of-coach attachments may block or obstruct egress. Be aware of cargo that may obstruct a path to doors. Avoid parking too close to lakes, steep cliffs, or other vehicles.**

# AIRSTREAM®

## Section 3 GENERAL INFORMATION

LIMITED WARRANTY POLICY . . . . .	3-2	CAMPING . . . . .	3-7
This Limited Warranty Covers . . . . .	3-2	Suggested Pre-Travel Check List . . . . .	3-7
Coverage Ends . . . . .	3-2	Exterior . . . . .	3-7
Limitation Of Implied Warranties . . . . .	3-2	Interior . . . . .	3-7
Disclaimer Of Incidental And Consequential Damages . . . . .	3-2	Touring Coach Equipment and Accessories	3-7
Repair Remedy . . . . .	3-2	Motoring Essentials . . . . .	3-7
Back-Up Remedy . . . . .	3-3	Overnight Stop . . . . .	3-8
What Is Not Covered . . . . .	3-3	Overnight or Weekend Trips . . . . .	3-8
Obtaining Warranty Service . . . . .	3-4	Longer Trips . . . . .	3-8
Consumer Arbitration Program . . . . .	3-5	Extended Stay . . . . .	3-8
Events That Discharge Airstream's Obligations Under This Limited Warranty . . . . .	3-5	Leveling . . . . .	3-8
Legal Remedies . . . . .	3-5	Effects of Prolonged Occupancy . . . . .	3-9
Airstream Limited Warranty Excludes . . . . .	3-5	About Molds . . . . .	3-9
Normal Wear . . . . .	3-5	What are molds . . . . .	3-9
Accident . . . . .	3-5	What factors contribute to mold growth . . . . .	3-9
Abuse . . . . .	3-5	How can mold growth be inhibited . . . . .	3-10
Exposure . . . . .	3-5	Waste Water System. . . . .	3-10
Overload . . . . .	3-5	Things Not to Put into Toilet or Drains . . . . .	3-10
Chemical Gassing . . . . .	3-5	Drain System . . . . .	3-10
ProMaster Van . . . . .	3-6	Winter Traveling . . . . .	3-11
SERVICE . . . . .	3-6	Heated Tanks . . . . .	3-11
Coach-Net® Roadside Assistance . . . . .	3-6		
Service Centers . . . . .	3-6		
Reporting Safety Defects . . . . .	3-7		

## Limited Warranty Policy

### This Limited Warranty Covers

(i) The first retail owner and any subsequent owners  
(ii) ONLY those portions of a NEW motorhome not excluded under the section “What is Not Covered,” when sold by an authorized dealership and used for its intended purpose of recreational travel and camping; and, (iii) ONLY defects in workmanship performed and/or materials used to assemble those portions of your motorhome not excluded under the section “What is Not Covered.” “Defect” means the failure of the workmanship performed and/or materials used to conform with the design and manufacturing specification and tolerances of Airstream. This Limited Warranty is transferable, and the subsequent owner’s warranty coverage period shall be the unexpired balance of the original warranty coverage period. A completed copy of the Warranty Transfer Form must be submitted to Airstream at the time of resale.

When you request and accept the performance of warranty repairs under the terms of this Limited Warranty, you are accepting all terms of this Limited Warranty, including by way of example, warranty limitations and disclaimers, the forum selection clause and the clause reducing the time period when suit must be filed for breach.

If any term or condition in this limited warranty conflicts with your state’s Uniform Commercial Code (“UCC”) as interpreted by courts within your state, the provisions of your state’s UCC are varied as allowed for by USS 1-302.

### Coverage Ends

36 months after the first retail owner first takes delivery of the motorhome from an authorized dealership OR after the odometer reaches 36,000 miles, whichever occurs first. Any action for breach of this warranty or any implied warranties must be commenced not more than 37 months after you first take delivery. Some states do not allow the reduction of the time when a breach of warranty claim must be commenced, so the reduction in time when a breach of warranty claim must be commenced may not apply to you.

## Limitation Of Implied Warranties

Implied warranties arising under applicable law, if any, including but not limited to implied warranties of merchantability or fitness for a particular purpose, are hereby limited in duration to the term of this limited warranty and are limited in scope of coverage to those portions of the motorhome covered by this limited warranty. There are no express warranties or any implied warranties of merchantability on those portions of the motorhome excluded from coverage. There is no warranty of any nature made by Airstream beyond that contained in this limited warranty. No person has authority to enlarge, amend, or modify this limited warranty. The dealer is not Airstream’s agent. Airstream is not responsible for any undertaking, representation, or warranty made by any dealer or others beyond those expressly set forth within this limited warranty. Some states do not allow limitations on how long an implied warranty lasts, so the above limitations may not apply to you.

## Disclaimer Of Incidental And Consequential Damages

Airstream disclaims any and all incidental and consequential damages, including but not limited to expenses such as transportation to and from dealerships and Airstream repair facilities, loss of time, loss of pay, loss of use, inconvenience, commercial loss (including but not limited to lost profits), towing charges, bus fares, vehicle rental, service call charges, gasoline expenses, incidental charges such as telephone calls and facsimile transmissions, and expenses for lodging and moisture damage such as mold and mildew as well as rust and corrosion. This disclaimer is independent of any failure of the essential purpose of any warranties provided with the motorhome and shall survive any determination that a warranty failed of its essential purpose. Some states do not allow the exclusion or limitation of incidental or consequential damages, so the above limitation or exclusion may not apply to you.

## Repair Remedy

Airstream’s sole and exclusive obligation is to repair any covered defects discovered within the warranty coverage period if: (1) within 10 days of your discovery of a defect, you notify Airstream OR an authorized dealership of the defect; AND (2) you deliver your Motorhome to Airstream OR an authorized dealership at your cost and expense.



### Back-Up Remedy

If the primary repair remedy fails to successfully cure any defect after a reasonable number of repair attempts, your sole and exclusive remedy shall be to have Airstream pay an independent service shop of your choice to perform repairs to the defect, which requires the exercise of good faith. If you select an independent service shop, you must notify Airstream to allow it to work directly with the service shop to have repairs performed. The repair remedy and the back-up remedy MUST both be exhausted AND these remedies must fail to fulfill their essential purpose before you can seek other legal or equitable remedies for breach of this express warranty or for breach of any implied warranty. This limited warranty is not a warranty that promises or extends to future performance because the warranty does not make a representation on how your motorhome will perform in the future but instead represents only what the remedy will be if a defect exists.

Unless prohibited by state law, repairs will not extend the time when you must commence a breach of warranty claim and shall not extend the warranty coverage period. Any performance of repairs after the warranty coverage ends OR any performance of repairs to those portions of your motorhome excluded from coverage shall be considered “good will” repairs. Warranty repairs should be expected. Airstream may use new and/or remanufactured parts and/or components of substantially equal quality to complete a repair. Damage to interior or exterior surfaces, trim, upholstery, and other appearance items may occur at the factory during assembly, during delivery of the motorhome to your selling dealer or on the selling dealer’s lot. Normally, any damage is detected and corrected at the factory or by the selling dealer during the inspection process. If you discover any damage when you take delivery of your motorhome, you MUST notify your dealer OR Airstream within 10 days of the date of purchase to have damage repaired at no cost to you. Minor adjustments, such as adjustments to the interior or exterior doors, drawers, latches will be performed at no cost to you by your selling dealer during the first 90 days of warranty coverage; thereafter, such adjustments are your exclusive responsibility as normal maintenance.

### What Is Not Covered

1. Tires, batteries, lithium power systems, stereo, television, range/stove, furnace, refrigerator, air conditioner, toilet, water heater, microwave, generator, glass breakage, and other materials, parts and components warranted by persons or entities other than Airstream. Please refer to the warranties of component manufacturers for terms and conditions of coverage;
2. Components of the multiplex systems, including monitoring and control, and related hardware and software manufactured and/or warranted by persons or entities other than Airstream.
3. Accessories and equipment that are working as designed, but which you are unhappy because of the design;
4. Any part or component of the vehicle that was not manufactured or installed by Airstream;
5. Normal deterioration due to wear or exposure, including but not limited to upholstery, flooring rust, corrosion, oxidation, and cosmetic blemishes;
6. Normal maintenance and service items, including but not limited to light bulbs, fuses, lubricants, sealants and seals, door adjustments, and awning tension;
7. After-market equipment or accessories installed on the vehicle after completion of manufacture by Airstream, or any defects or damage caused by such items;
8. Vehicles not purchased through an authorized dealer of Airstream and vehicles purchased directly or indirectly through auction, salvage, repossession, or other non-customary sale means;
9. Any motorhome used other than for temporary recreation purposes, including, but not limited to, use of the motorhome for residential, rental, business and commercial purpose or any motorhome purchased by, registered by, or titled in the name of a business association (such as any LLC, corporation, or partnership). If the motorhome owner or user files a tax form claiming a business or commercial tax benefit or income related to the motorhome, it shall be irrefutable that the motorhome has been used for rental, commercial or business purposes.

## General Information

---

10. Defects or damage caused by, in whole or in part, or in any way related to: Accidents, misuse (including off-road use), or negligence; Failure to comply with the instructions set forth in any owner's manual provided with the vehicle; Alteration or modification of the vehicle except such alterations or modifications approved in writing by Airstream; Acts of God or other environmental conditions, such as lightning, hail, salt causing rust, or other chemicals in the atmosphere; De-icing agents or other chemicals applied to the vehicle; Failure to properly maintain or service the vehicle, including but not limited to the maintenance of lubricants, sealants, and seals; Condensation and the results of condensation including water damage and the growth of mold or mildew. Mold and mildew are natural growths given certain environmental conditions and are not covered by the terms of this Limited Warranty; The addition of weight to the vehicle that causes the total weight to exceed applicable vehicle weight ratings, or addition of weight causing improper distribution of the weight of the vehicle; Failure to seek and obtain repairs in a timely manner; Failure to use reasonable efforts to mitigate damage caused by defects; Failure to properly ventilate the vehicle; Improper electric power supply or improper vehicle hookup to other facilities; Acts or omissions of any person or entity other than Airstream. (Note: An irrefutable presumption arises the motorhome has been used for commercial and/or business purposes if the motorhome owner or user files a tax form claiming any business or commercial tax benefit related to the motorhome, or if the motorhome is purchased, registered or titled in a business name.)
11. Software embedded in Airstream products; mobile applications and other software which may be downloaded to smartphones and other devices; advanced monitoring, control, and other services offered by or on behalf of Airstream in connection with such embedded software, mobile applications, and downloadable software; and data transmission, hotspot, and other connectivity services associated with your motorhome.

### Obtaining Warranty Service

In order to obtain warranty service under this Limited Warranty, the owner must do all of the following:

1. Owner and dealer representative must complete, sign, and return the Customer Performance Checkout within 10 days from delivery of the vehicle;
2. Notify Airstream or one of its authorized, independent dealers, of any claimed defect within the warranty period or 10 days thereafter;
3. Provide notification of a defect within 10 days of discovery of that defect; and
4. Promptly return the vehicle to an authorized Airstream dealer or Airstream for repairs.

If you believe a defect covered by this Limited Warranty still exists after an attempted repair by an authorized Airstream dealer, you must contact Airstream in one of the following manners, and specify:

1. The complete serial number of the vehicle;
2. The date of original purchase and the date of original delivery;
3. The name of the selling dealer; and
4. The nature of the problem and the steps or service which have been performed.

Email: [support@airstream.com](mailto:support@airstream.com)

Phone: (937) 596-6111

Mail: AIRSTREAM, INC., 428 West Pike Street, P.O. Box 629, Jackson Center, Ohio 45334-0629, Attention: Owner Relations Department

Airstream may direct you to an authorized Airstream dealer, or may request that you bring your motorhome to the Airstream factory in Jackson Center, Ohio for repairs.

Airstream does not control the scheduling of repairs at its authorized Airstream dealers, and repairs at the Airstream factory may not be immediately available. Therefore, you may encounter delays in scheduling repairs and/or completion of repairs. All costs associated with transporting the motorhome for any warranty service shall be the sole responsibility of the owner.

### Consumer Arbitration Program

For recreation vehicles purchased in the State of California, Airstream, Inc. participates in the Consumer Arbitration Program for Recreation Vehicles (CAP-RV). This third-party dispute resolution program is available, at no charge to you, to settle unresolved warranty disputes for recreation vehicles. This dispute resolution program reviews eligible product and service related complaints involving warranty covered components. To find out more about this program, or to request an application/brochure, please call the Arbitration Administration office toll-free 800.279.5343. The CAP-RV program operates as a certified mechanism under the review of the California Arbitration Certification Program. Members of the armed forces who purchased the vehicle in California, or who were stationed in or a resident of California at the time of purchase (regardless of state of purchase) or who are stationed in California at the time of application to this program may utilize the CAP-RV program.

### Events That Discharge Airstream's Obligations Under This Limited Warranty

Misuse or neglect, accidents, unauthorized alteration, failure to provide reasonable and necessary maintenance (see Owner's Manual), damage caused by off road use, collision, fire, theft, vandalism, explosions, overloading in excess of rated capacities, odometer tampering, and use of the motorhome for commercial, business, or rental purposes shall discharge Airstream from any express or implied warranty obligation.

### Legal Remedies

Exclusive jurisdiction for deciding legal disputes relating to alleged breach of express warranty and breach of implied warranties arising by operation of law as well as those relating to representations of any nature rests in the courts within the state of manufacture, which is Ohio. Also, this limited warranty shall be interpreted and construed in accordance with the laws of the State of Ohio. Any and all claims, controversies, and causes of action arising out of or relating to this limited warranty, whether sounding contract, tort or statute, shall be governed by the laws of the State of Ohio, including its statute of limitations, without giving effect to any conflict of law rule that would result in the application of the laws of a different jurisdiction. If state law gives you additional rights that conflict with any term of this limited warranty, your state law applies over inconsistent warranty terms. For example, if you took delivery of your RV in California, the Song Beverly Warranty Act applies because it cannot be waived.

### Airstream Limited Warranty Excludes

#### *Normal Wear*

Items such as curtains, upholstery, floor coverings, and window, door, and vent seals will show wear or may even wear out within the 3-year warranty period, depending upon the amount of usage, weather, and atmospheric conditions.

#### *Accident*

We strongly urge our dealers and customers to inspect the touring coach upon receipt of delivery for any damage caused by accident while being delivered to the dealer, or while it is on the dealer's lot. Damage of this nature becomes the dealer or customer's responsibility upon acceptance of delivery, unless Airstream is notified and the person making the delivery verifies the damage. Glass breakage, whether obviously struck or mysterious, is always accidental and covered by most insurance policies.

#### *Abuse*

Lack of customer care and/or improper maintenance will result in early failure for which Airstream cannot be held responsible.

#### *Exposure*

Deterioration by sunlight is possible to such items as tires, curtains or upholstery. Steel or metal surfaces are subject to the elements, causing rust and corrosion that is normal and beyond the control and responsibility of Airstream.

#### *Overload*

Overload Damage due to loading beyond capacity or to cause improper balance is not covered by the Airstream Limited Warranty. The Airstream Touring Coach is engineered to properly handle any normal load. There are limits to the amount of load that can be safely transported depending upon speed and road conditions. If these limits have been exceeded, the Airstream Limited Warranty will not cover resulting damage. For additional information on the load capacity of your touring coach, consult your Sprinter and Airstream Owner's Manuals or gross vehicle weight rating plate.

#### *Chemical Gassing*

Chemical gassing is not a "Defect" in your recreational vehicle and is not covered by the Limited Warranty. Please follow the recommendations in this manual to address this concern.

# General Information

## ProMaster Van

Airstream, Inc., does not accept any responsibility in connection with any of its touring coach's for the ProMaster Van or its components. The ProMaster Van and its components are covered by Ram Warranties as explained by ProMaster literature provided. Your ProMaster Van and its components are pre-checked by its manufacturer before delivery to Airstream. All service to the ProMaster Van and its components must be performed by Ram ProMaster designated service points according to the manufacturer's warranty and service policies. The literature provided with each touring coach gives important information concerning its warranty coverage, maintenance, and operation.

The Airstream Rangeline Owner's Manual may provide additional information and tips on the use of the van as a touring coach, however, no information, in whole or in part, in any Airstream manual should be interpreted as advice or directions to disregard or void the Warnings, Cautions, Notices, or other information contained in the ProMaster's manuals.

### **⚠ WARNING**

**Your Ram ProMaster Van Owner's and Warranty Manuals contain important cautions, warnings, operational, and warranty information on the ProMaster and its components. All information in the ProMaster manual should be reviewed and followed for your safety.**

## Service

### Coach-Net® Roadside Assistance



Every new Airstream comes with a three-year, transferable subscription to Coach-Net which includes a long list of premium services to help quickly solve issues or learn about your Airstream.

To learn more, scan the QR code above, navigate to <https://www.airstream.com/owners/coach-net/>, or call Coach-Net at 855-817-1885. On-call technicians are always ready to answer questions.

## Service Centers

Before leaving the factory, every vital part of the touring coach is tested for performance. Each test is signed and certified by an inspector. After the touring coach arrives on your dealer's lot, all vital parts and systems are again tested. When you take delivery of your new touring coach, you will receive a complete check out.

At that time, a specified list of performance checks on your touring coach equipment will be conducted, and any deficiencies you have experienced since taking delivery will be corrected.

Please contact your dealer if your touring coach needs service. Major service under your Airstream Limited Warranty is available through our nationwide network of Airstream Dealer Service Centers. To find a dealer, please visit, <https://www.airstream.com> to use our dealer locator.

Occasionally, dealerships change, or new dealers are added that may not appear on the website immediately. Please note that all centers operate on an appointment basis for the utmost efficiency.

When you require service for your touring coach from the Airstream Factory Service Center or a Certified Dealer Service Center, please contact the service manager for an appointment, and inform them if you are unable to keep the appointment date or wish to change it. Service may be arranged at the Factory Service Center by contacting the Service Coordinator at:

Airstream Factory Service Center

428 West Pike Street

P.O. Box 629

Jackson Center, Ohio 45334-0629

Phone: (937) 596-6111 or (877) 596-6111

### **NOTE**

**Connected RV features and systems may be turned off while in a service facility for the safety of our technicians. You might have to re-pair your personal device after service appointment.**

**Reporting Safety Defects**

If you believe your vehicle has a defect which could cause a crash or could cause injury or death, you should immediately inform the National Highway Traffic Safety Administration (NHTSA), in addition to notifying Airstream, Inc.

If NHTSA receives similar complaints, it may open an investigation, and if it finds that a safety defect exists in a group of vehicles, it may order a recall and remedy campaign. However, NHTSA cannot become involved in individual problems between you, your dealer, or Airstream Inc.

To contact NHTSA, you may either call the Vehicle Safety Hotline toll-free at 1-888-327-4236 (TTY: 1-800-424-9153), go to <https://www.nhtsa.gov>, or write to:

Administrator

NHTSA

1200 New Jersey Avenue, S.E.

Washington, DC 20590

You can also obtain other information about motor vehicle safety from <https://www.nhtsa.gov>.

**Camping****Suggested Pre-Travel Check List*****Exterior***

1. Verify power cord is stored.
2. Verify water and sewer hoses are stored.
3. Double check all hitch connections (if towing).
4. Look under, over, and around the vehicle for any overlooked items.
5. Check exterior lighting.
6. Check torque of wheel bolts or lug nuts.
7. Check tires for correct pressure.

***Interior***

1. Turn off water pump, heating/hot water system.
2. Close windows and vents.
3. Close all interior cabinet doors.
4. Latch refrigerator door. (Seal containers first.)
5. Latch microwave.
6. Secure, stow, and latch for travel anything that will move, fall, fly, or open.
7. Drain toilet bowl.
8. Turn off 12-volt lights.

***Touring Coach Equipment and Accessories***

1. Water hose, 5/8-in. high-pressure, tasteless, odorless, non-toxic (two 25-ft. sections).
2. Y connection - water hose.
3. Holding tank cleaner and deodorizer.
4. Power cord adapter, 15 amp - 30 amp.
5. Electric cord, 30-amp capacity.
6. Wheel chocks.
7. Torque wrench.
8. Quality tire gauge.

***Motoring Essentials***

1. Touring coach registration.
2. Carry driver's license.
3. In Canada, bring along a non-residence liability insurance card and your passport.
4. In Mexico, you must have special auto insurance.
5. Carry an extra set of the ignition keys in a separate pocket or in your wallet.
6. Keep an operating flashlight with fresh batteries in the glove compartment.
7. Carry your pet's dish, food, leash, and health and registration papers.

# General Information

---

## Overnight Stop

In time you will develop a knack for spotting wonderful little roadside locations by turning off the main highway and exploring. There are many modern recreational vehicle parks, including State, County, and Federal parks with good facilities, where you may obtain electrical, water, and sewer hookups and connections. Directories are published which describe in detail these parks and tell what is available in the way of services and hookups.

All you need to do to enjoy the self-contained luxury while boondocking is to:

1. Turn on the 12-volt battery disconnect switch to provide power to your components.
2. If you need to cook or run the air conditioner:
  - Start the generator.
  - Turn the inverter on to power the microwave and outlets on the inverter circuit (identified by the affixed "Inverter Circuit" label). To conserve battery power, turn off the inverter when not in use.
3. Turn on the water pump and open faucets until air is expelled from the system.

Before moving on, turn off appliances, water pump, and battery disconnect. Check your campsite, both for cleanliness and to be sure you have not left anything behind. Make sure everything is properly stowed.

## Overnight or Weekend Trips

On overnight or weekend trips, chances are you will not use up the capacity of the holding tanks or deplete the water supply if using the system moderately or conservatively. You will need to maintain the level of your house battery during this time by plugging into shore power or by starting your generator.

## Longer Trips

On a longer trip, when you have stayed where sewer connections and utility hookups were not available, it will be necessary for you to stop from time to time to dispose of the waste in the holding tank and replenish the water supply. Many truck stops and gas stations, chain and individually owned, have installed sanitary dumping stations for just this purpose. Booklets are available that list these facilities.

When you stop for the night, your Airstream Touring Coach is built to be safely parked in any spot that is relatively level and where the ground is firm.

## Extended Stay

Making a long trip is not very different from making a weekend excursion. Since everything you need is right at hand, you are at home wherever you go. When packing for an extended trip, take everything you need, but only what you need.

Hook up to water by attaching a ½ -inch minimum high-pressure water hose to the city water service.

Plug the 120-volt, 30-amp electrical cable into the city power service. The SmartPlug incorporates a reverse polarity feature which includes a series of light codes to let you know the condition of the power coming from the campsite power pedestal. Please refer to the provided SmartPlug owner's manual for more information on reverse polarity and the light codes; also see [Shoreline Power Inlet and Cordset on page 6-7](#).

To use the generator, you simply start it. All switching is done automatically. The generator can be started from the Multiplex Systems control panel or the bed area RF remote. It is easier on your generator and appliances if you'll allow the generator to reach its normal operating speed (about a minute) prior to applying heavy current loads.

Your Touring Coach is equipped with an Automatic Generator Start System (AGS). The purpose of an AGS system is to automatically start (and run) the generator when the 12 volt electrical system (house battery) drops to a pre-determined level; see [Generator on page 5-17](#).

When you stay for extended periods where electric or water hookups are not available, you must make regular checks on the state of charge of your battery and the contents of your water tank (Multiplex control panel). Carry drinking water in a clean container to refill your tank. When your waste tank nears capacity, move your touring coach to a dumping location.

## Leveling

When you plan to stay in the same place for several days, weeks, or months, you will want your touring coach to be as level as possible. Check the attitude with a small spirit level set on the inside work counter. If a correction is necessary, then you must first level from side to side. This can be done most easily by driving up a small ramp consisting of 2 in. x 6 in. boards tapered at both ends. Airstream does not recommend placing tires in a hole for leveling.

**Effects of Prolonged Occupancy**

Your touring coach was designed primarily for recreational use and short-term occupancy. If you expect to occupy the touring coach for an extended period, be prepared to deal with condensation and the humid conditions that may be encountered. The relatively small volume and tight compact construction of modern recreation vehicles mean that the normal living activities of even a few occupants will lead to rapid moisture saturation of the air contained in the touring coach and the appearance of visible moisture, especially in cold weather.

Just as moisture collects on the outside of a glass of cold water during humid weather, moisture can condense on the inside surfaces of the touring coach during cold weather when relative humidity of the interior air is high. This condition is increased because the insulated walls of a recreation vehicle are much thinner than house walls. Estimates indicate that two adults can vaporize up to one-and-a-half gallons of water daily through breathing, cooking, bathing, and washing. Unless the water vapor is carried outside by ventilation or condensed by a dehumidifier, it will condense on the inside of the windows and walls as moisture, or in cold weather as frost or ice. It may also condense out of sight within the walls or the ceiling where it will manifest itself as warped or stained panels. Appearance of these conditions may indicate a serious condensation problem. When you recognize the signs of excessive moisture and condensation in the touring coach, action should be taken to minimize their effects.

**NOTICE**

**Your touring coach is not designed, nor intended, for permanent housing. Use of this product for long term or permanent occupancy may lead to premature deterioration of structure, interior finishes, fabrics, carpeting, and drapes. Damage or deterioration due to long-term occupancy may not be considered normal, and may under the terms of the warranty constitute misuse, abuse, or neglect, and may therefore reduce the warranty protection.**

To avoid condensation problems, try to follow these tips to help alleviate excess moisture:

- Allow excess moisture to escape to the outside when bathing, washing dishes, hair drying, laundering, and using appliances. Always use an exhaust fan when cooking.

- Keep the bathroom door closed and the vent or window open when bathing and for a period of time after you have finished.
- If you are experiencing condensation, you may want to reconsider hanging wet clothes in the touring coach to dry.
- In hot weather, start the AC early as it removes excess humidity from the air while lowering the temperature.
- Keep the temperature as reasonably cool during cold weather as possible. The warmer the vehicle, the more cold exterior temperatures and warm interior temperatures will collide on wall surfaces, thus creating condensation.
- Use the ceiling vent to keep air circulating inside the vehicle so condensation and mildew cannot form in dead air spaces. Allow air to circulate inside closets and cabinets (leave doors partially open). Please keep in mind that a closed cabinet full of stored goods prevents circulation and allows the exterior temperature to cause condensation.
- The natural tendency would be to close the vehicle tightly during cold weather. This will actually compound the problem. Simply put, you need to remove some of the warm air and allow some cool outside air to get inside the vehicle so the furnace will not recycle the humid interior air.
- Minimize the use of incandescent lights, which produce heat and contribute to condensation.

**About Molds**

***What are molds***

Molds are microscopic organisms that naturally occur in virtually every environment, indoors and out. Outdoors, mold growth is important in the decomposition of plants. Indoors, mold growth is unfavorable. Left unchecked, molds break down natural materials, such as wood products and fabrics. Knowing the potential risks is important for any type of homeowner to protect their investment.

***What factors contribute to mold growth***

For mold growth to occur, temperatures, indoor or outdoors, must be between 40°F and 100°F and also, there must be a source of moisture, such as humidity, standing water, damp materials, etc. Indoors, the most rapid growth occurs with warm and humid conditions.

# General Information

## How can mold growth be inhibited

By controlling relative humidity, the growth of mold and mildew can be inhibited. In warm climates, use of the air conditioner will reduce the relative humidity. Vents are located in the bathing and cooking areas and constant use is advised during food preparation and bathing, even during colder weather. Additionally, opening a window during these activities will assist in ventilation. In extremely humid conditions, the use of a dehumidifier can be helpful. If using a dehumidifier, please read and follow all manufacturer instructions and recommendations to the use and cleaning of the dehumidifier.

Frequent use of your touring coach or cleaning regularly is an important preventive measure. Further, any spills should be wiped up quickly and dried as soon as possible. Avoid leaving damp items lying about. On safe surfaces, use mold or mildew killing cleaning products. Check sealants regularly, and reseal when necessary to avoid water leaks. Proper preventive maintenance to the touring coach and its accessories, as described both in this manual and in accompanying literature, will provide the best protection to the touring coach.

## Waste Water System

The main parts of the waste water system are the toilet, holding tanks, and tank dump valves; see [Drain and Waste System on page 9-8](#). The system is designed to provide complete self-contained toilet facilities, while on the road or parked, without being connected to a sewage line. It may also be used when parked while connected to a sewage hose.

Keep the dump valves closed with either method and empty the tanks when they are nearly full. The idea is to send a large volume of water through the tanks and hose at the same time to float solids away.

After the black tank has been emptied, close the dump valves and charge the tank by putting a few gallons of water in the holding tank using the flush inlet. This will spray the interior of the tank with water and help prevent solids from building up in the sewage holding tank. The addition of a deodorizing agent like Aqua-Kem will help prevent odors.

Should you ever have a buildup of solids, close the valves, fill the tanks about 3/4 full with fresh water, drive a distance to agitate the solids, and drain the tanks.

## Things Not to Put into Toilet or Drains

- Facial tissues and feminine hygiene products (they do not dissolve like toilet paper).
- Automotive antifreeze, ammonia, alcohols, or acetone.
- Table scraps or other solids that may clog the drains.

## Drain System

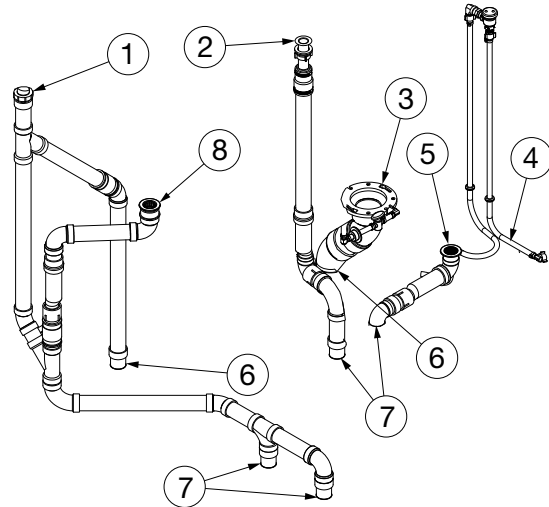

1. Vent
2. Lavy Drain
3. Toilet Drain
4. Black Tank Flush (No Fuss Flush System)
5. Shower Drain
6. Black tank Connections
7. Gray Tank Connections
8. Galley Sink Drain



**Winter Traveling**

Traveling in sub-freezing temperatures will require certain precautions to protect the plumbing system and your personal belongings from being damaged by freezing. Consider how cold it will get, how long it will be before you turn the heat back on, and if the temperature is falling or rising. Remember, when traveling, the wind chill factor will cause the interior of the touring coach to cool much faster than when it is parked

1. You must have at least 1/4 tank of fuel to run the hydronic heating/hot water system as the heat from the furnace warms the touring coach and keeps the fresh water lines and black water holding tank from freezing. If your fuel tank drops below 1/4 tank, the hydronic system will automatically shut off. This 1/4 tank reserve is so you can travel to refuel.
2. If your stay is longer than overnight, you should endeavor to have a shoreline hookup.
3. Minimize use of electricity if 120-volt power source is not available.
4. Leave cabinet doors, wet bath doors, and wardrobe doors slightly open at night to allow circulation of air in and around all components.
5. Save power by using non-toxic RV- approved antifreeze in the gray and black water holding tanks instead of the heating pad to prevent freezing. Quantity of antifreeze needed will vary with ambient temperature and the amount of liquids in tank.
6. For extended stays in cold weather, insulate all water lines outside the touring coach. You should remember that low temperatures in combination with high winds cause an equivalent chill temperature much below what your thermometer is reading. For instance, with an outside temperature of zero degrees, and the wind velocity of 10 miles per hour, the equivalent chill temperature is -20°F.

**Heated Tanks**

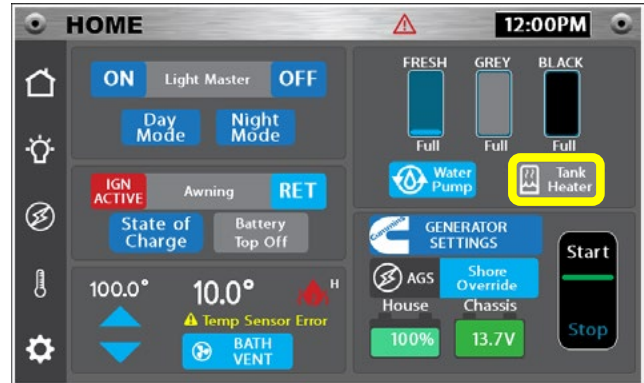

Your touring coach has 12-volt heat pads on the black water tank, gray water tank, and on the pipe elbows of the dump valve to help prevent freezing. The heat pads are controlled by the touch screen Multiplex control panel. When the outside temperature is near freezing, simply switch ON the tank heaters. Built-in sensors will activate the heat pads when the contents drop to 44°F. Once the liquid is heated and rises to 64°F the heat pads will automatically deactivate. Turn the power OFF when the outside temperature remains above freezing or if the tanks are empty. The tank heaters will quickly deplete the house battery unless the unit is plugged into an external AC power source or the generator is used to operate the inverter/charger. To conserve battery power, RV antifreeze may be used to protect the gray and black tanks.

**NOTE**

**The fresh water tank is installed above the floor where heat from the furnace will help keep it from freezing.**

**NOTICE**

**Drain and winterize the water system when not being used during winter travel; see [Winterizing and Storage](#) on page 9-10.**



# AIRSTREAM®

## Section 4 FLOOR PLANS AND SPECIFICATIONS

FLOOR PLAN . . . . .	4-2
Rangeline . . . . .	4-2
SPECIFICATIONS . . . . .	4-3
Rangeline Specifications . . . . .	4-3
Specifications Definitions . . . . .	4-4
Specifications Labels . . . . .	4-4
Occupant and Cargo Carrying Capacity Label . . . . .	4-4
Tire and Loading Placard . . . . .	4-4
Manufacturer's Certification Label . . . . .	4-4

# Floor Plans And Specifications

---

## Floor Plan

### Rangeline

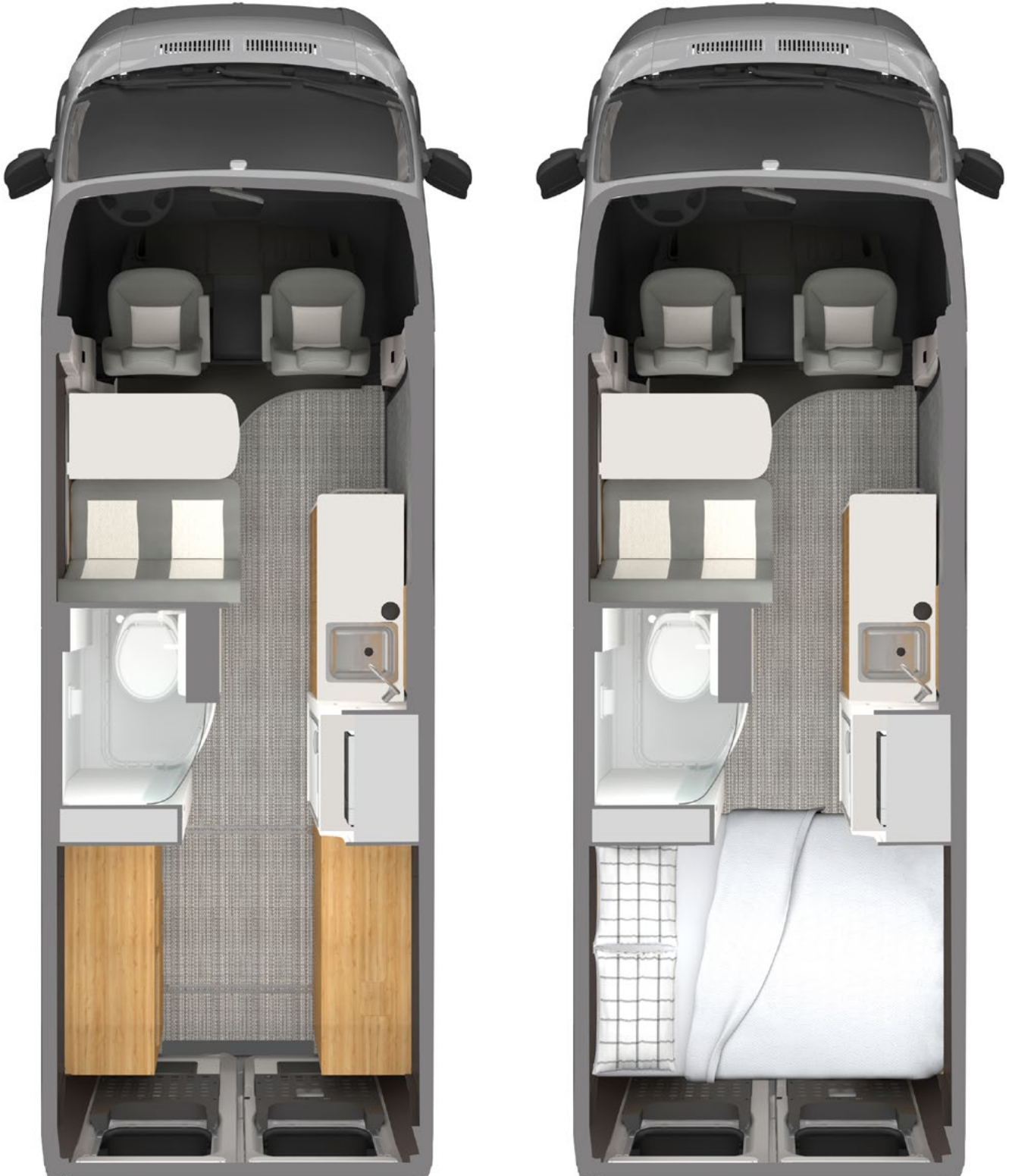

**Specifications**

<b>Rangeline Specifications</b>	
Chassis	Ram® ProMaster 3500 High Roof Extended, FWD
Engine	3.6L Pentastar® V6 24V VVT
Emissions	50 State Emissions
Horsepower/Torque	276HP @ 6,400RPM/250 lbs Torque @ 4,400RPM
Transmission	9-Speed Automatic 948TE
Axle Ratio	4.08
Wheelbase	159"
MPG <sup>[1]</sup>	18-20 Estimated Highway
Exterior Overall Length	20' 11"
Exterior Overall Height with A/C	9' 5"
Exterior Overall Width w/Mirrors	8' 2.25"
Interior Height	6' 2.25"
Interior Width	5' 11"
GVWR <sup>[2]</sup>	9,350 lbs
GCWR <sup>[2]</sup>	12,000 lbs
UVW/UBW <sup>[2]</sup>	Weights are listed on the OCCC Label and Tire and Loading Placard; for more information, see <a href="#">Specifications Labels on page 4-4</a>
OCCC <sup>[2]</sup>	
Tow Capacity <sup>[3]</sup>	Up To 3,500 lbs (See ProMaster Guidelines)
Hitch Tongue Weight	350 lbs
Fuel Tank	24 gallon
Fresh Water Tank	28 gallon
Gray Water Tank	19 gallon
Black Water Tank	12 gallon
Hydronic Heating/Hot Water System	Gasoline Fueled with 120V Element Support
Air conditioner	13,500 BTU w/Soft Start
12V Refrigerator w/Freezer Box	3.2 cubic feet (Refrigerator), .4 cubic feet (Freezer)
Microwave	.7 cubic feet
Cooktop	1,000 Watt, Single Burner, Induction
Battery (House)	12 Volt 270 Ah Deep Cycle Lithium Battery (LiFePO4)
Converter / Inverter	100 Amp Charger / 2,000 Watt True Sine Inverter
Generator	2.8 Kw Ultra Quiet w/ Auto Start (Gasoline Fueled)
Shore Power	30-Amp/120-Volt Service w/Smart Plug
Solar Power	200 Watts
Bed Sizes	2 PC Folding Bed System: 74" x 52.5" Pop-Top Bed: 78" x 50.5"
Wheel Fastener Torque Value <sup>[4]</sup>	145 ft-lbs
Tire Size / Max Cold Inflation Pressure <sup>[2][5]</sup>	Tire size and max cold inflation pressure are listed on the Tire and Loading Placard on the B-pillar (driver's door jamb); For more information, see <a href="#">Tire and Loading Placard on page 4-4</a>
Airstream Warranty	3 Years/36,000 Miles
Ram® Basic Limited Warranty	3 Years/36,000 Miles
Ram® Fleet Powertrain Care Warranty	5 Years/100,000 Miles

1. Actual mileage will vary based on load carrying, driving style, and road conditions.
2. For more information, see [Specifications Definitions on page 4-4](#) and see [Specifications Labels on page 4-4](#).
3. Tow capacity will vary with build spec and intended vehicle loading with people, cargo, and fluids.
4. For safety reasons, wheel fastener torque must be checked immediately after reinstalling wheels and again after 25 miles.
5. In this context, cold refers to how long a tire has sat idle. *Max cold inflation pressure* should be checked in the morning (after sitting idle for at least three hours) before driving more than one mile or before rising ambient temperatures and the sun's radiant heat can affect tire pressure.

# Floor Plans And Specifications

## Specifications Definitions

**Unloaded Vehicle Weight (UVW)** or Unit Base Weight (UBW) is the factory manufactured/empty weight of the touring coach. UVW includes fuel, engine and generator operating fluids, and all batteries; *UVW is listed as “factory manufactured weight” on the Tire and Loading Placard.*

**Gross Combined Vehicle Weight Rating (GCWR)** is the maximum weight rating of the vehicle with a trailer attached; *GCWR is listed on the previous page.*

**Gross Axle Weight Rating (GAWR)** is the value specified as the load carrying capacity of a single axle system, as measured at the tire-ground interfaces. This is the maximum amount of weight that can be placed on each axle; *GAWR is listed on the Manufacturer’s Certification Label.*

**Gross Vehicular Weight Rating (GVWR)** is the maximum permissible weight of the Touring Coach when fully loaded; *GVWR is listed on the Tire and Loading Placard and Manufacturer’s Certification Label. It is also listed on the previous page.*

**Occupant and Cargo Carrying Capacity (OCCC)** is the maximum total weight of all occupants, cargo, fresh water, and any tongue weight of a towed trailer; *OCCC is listed on the OCCC label and Tire and Loading Placard.*

**GVWR - UVW = OCCC**

**⚠ WARNING**

The combined weight of occupants and cargo should never exceed the limit on OCCC label.

**⚠ WARNING**

Wheel fastener torque must be checked immediately after reinstalling a wheel and again after 30 miles. Torque all wheel fasteners evenly to specification using the proper sequence; see [Wheel Bolt/Lug Nut Tightening on page 7-8](#). For torque values, see [Specifications on page 4-3](#).

**NOTE**

All product information and specifications listed are as accurate as possible at the time of printing. Since we continually strive to improve our products, all specifications are subject to change without notice.

**NOTE**

Specifications labels shown are examples only.

## Specifications Labels

### Occupant and Cargo Carrying Capacity Label

**MOTOR HOME OCCUPANT CARGO CARRYING CAPACITY**  
**VIN: XXXXXXXXXXXXXXXX**  
**THE COMBINED WEIGHT OF OCCUPANTS AND CARGO SHOULD NEVER EXCEED**  
**XXX kg OR XXX LBS**  
 Safety belts equipped seating capacity: X  
**CAUTION:**  
 A full load of water equals XX kg or XXX lbs of cargo @ 1kg/L (8.3lb/gal) and the tongue weight of a towed trailer counts as cargo.  
 Motor Home overall length XXX (XXX cm) as manufactured

The Occupant and Cargo Carrying Capacity Label on the edge of the passenger door lists the VIN, OCCC, safety belt equipped seating capacity, the weight of a full load of water, and the motorhome’s overall length.

### Tire and Loading Placard

**TIRE AND LOADING INFORMATION**  
**RENSEIGNEMENTS SUR LES PNEUS ET LE CHARGEMENT**

The combined weight of occupants and cargo should never exceed XXX kg or XXXX lbs.

SEATING CAPACITY TOTAL X FRONT X REAR X

TIRE PNEU	SIZE DIMENSIONS	COLD TIRE PRESSURE PRESSION DES PNEUS A FROID
FRONT AVANT	XXXXXXXXXX	XXX kpa (XX Psi)
REAR ARRIERE	XXXXXXXXXX	XXX kpa (XX Psi)
SPARE DE SECOURS	XXXXXXXXXX	XXX kpa (XX Psi)

SEE OWNERS MANUAL FOR ADDITIONAL INFORMATION  
 VOIR LE MANUEL DE L'USAGER POUR PLUS DE RENSEIGNEMENTS

XXXXXX

The factory manufactured weight of this motor home is XXXX kgs XXXX (lbs).  
 The GVWR of this motor home is XXXX kgs XXXX (lbs).

The Tire and Loading Placard on the B-pillar (driver’s door jamb) lists OCCC, UVW, GVWR, seating capacity, tire size, tire cold inflation pressure, and the last six digits of the serial number.

### Manufacturer’s Certification Label

**MANUFACTURED BY : AIRSTREAM, INC**

GVWR:	XXXX kg/	XXXX lb	DATE: XXXXXXXX	XXX
<b>GAWR</b>	<b>TIRES</b>	<b>RIMS</b>	<b>COLD INFL.PRESS.</b>	
<b>FRONT</b>	XXXXXXXXXX	XXXX	XXX KPA	<b>SINGLE</b> <input checked="" type="checkbox"/>
XXXX KG/ XXX LB			XX PSI	<b>DUAL</b> <input type="checkbox"/>
<b>INTERM</b>			PSI	<b>SINGLE</b> <input type="checkbox"/>
				<b>DUAL</b> <input type="checkbox"/>
<b>REAR</b>	XXXXXXXXXX	XXXX	XXX KPA	<b>SINGLE</b> <input checked="" type="checkbox"/>
XXXX KG/ XXX LB			XX PSI	<b>DUAL</b> <input type="checkbox"/>

THIS VEHICLE CONFORMS TO ALL APPLICABLE U.S. FEDERAL MOTOR VEHICLE SAFETY STANDARDS IN EFFECT ON THE DATE OF MANUFACTURE SHOWN ABOVE ALL WEIGHTS ARE APPROXIMATE

V.I.N./N.I.V.:XXXXXXXXXXXXXXXXXX TYPE/TYPE: XXXXXXXX MODEL: XXXXXX  
 XXXXXXXXXXXXXXXXXXXX XX XXX Serial: XXXXXXXXXXXXXXXXXXXX

The Manufacturer’s Certification Label on the driver’s side inner door panel lists the GVWR, GAWR, date of manufacture, tire size, rim size, tire cold inflation pressure, VIN/NIV number, vehicle type, model, and the full serial number.

# AIRSTREAM®

## Section 5 INTERIOR

GENERAL INFORMATION AND CLEANING . . . . .	5-3	Pop-Top. . . . .	5-9
Upholstery . . . . .	5-3	Opening the Pop-Top . . . . .	5-9
Cabinets, Overhead Lockers, and Countertops	5-3	Closing the Pop-Top . . . . .	5-9
Aluminum Interior Skin . . . . .	5-3	Cleaning and Sealing . . . . .	5-10
Sinks . . . . .	5-3	Pet Amenities . . . . .	5-10
Luxury Woven Vinyl Floor . . . . .	5-3	Table . . . . .	5-11
General Cleaning . . . . .	5-3	ELECTRICAL SYSTEM OVERVIEW . . . . .	5-11
Interior Doormat and Rug Selection . . . . .	5-4	Power Center . . . . .	5-11
Window Coverings . . . . .	5-4	Circuit Breaker Protection . . . . .	5-12
Wet Bath . . . . .	5-4	Ground Fault Circuit Interrupter (GFCI) . . . . .	5-12
Shower Head . . . . .	5-4	GFCI Breaker Test . . . . .	5-12
Toilet . . . . .	5-5	Fuses . . . . .	5-12
Deodorizers and Biological Chemicals . . . . .	5-5	120 volt System . . . . .	5-13
Lavy Fold Down Sink . . . . .	5-5	City Power Overview . . . . .	5-13
Faucets . . . . .	5-5	Outlets and USB ports . . . . .	5-13
Lavatory Fold Down Faucet . . . . .	5-5	Energy Management System (EMS) . . . . .	5-14
Galley Faucet . . . . .	5-5	12 Volt System . . . . .	5-14
Faucet Cleaning and Care . . . . .	5-5	Solar System. . . . .	5-14
Storage . . . . .	5-6		
Cabinets, Roof Lockers, and Cubbies . . . . .	5-6		
Towel Hooks and Key Holder . . . . .	5-6		
L-Track Cargo Rails and Molle Panel Storage . . . . .	5-6		
Second Row Bench Seat . . . . .	5-7		
Folding Bed and Access Step . . . . .	5-8		
Folding Bed Operation . . . . .	5-8		
Bed Access Step . . . . .	5-8		

## Section 5 Interior

ELECTRICAL SYSTEM OPERATION . . . . .	.5-15	ENTERTAINMENT SYSTEMS . . . . .	.5-23
Battery Disconnect Switch . . . . .	.5-15	Wireless Bluetooth® Speaker . . . . .	.5-23
House Battery . . . . .	.5-15	Cordless Phone Charger/Holder . . . . .	.5-23
Battery Management System (BMS) . . . . .	.5-16	TV and Antenna Prewire . . . . .	.5-23
High Voltage Disconnect . . . . .	.5-16	Airstream Connected, Wi-Fi . . . . .	.5-23
Low-Voltage Disconnect . . . . .	.5-16	APPLIANCES . . . . .	.5-24
Temperature Limits . . . . .	.5-16	Maintenance . . . . .	.5-24
Cold Weather Usage . . . . .	.5-16	Air Conditioner . . . . .	.5-24
Inverter/Charger . . . . .	.5-17	Cooktop . . . . .	.5-24
Generator . . . . .	.5-17	Ceiling Vent Fan . . . . .	.5-25
Automatic Generator Start (AGS) . . . . .	.5-18	Operation . . . . .	.5-25
Automatic Transfer Switch . . . . .	.5-18	Ceiling Fan Mode . . . . .	.5-25
Battery Charging . . . . .	.5-19	Cleaning Instructions . . . . .	.5-25
State of Charge (SOC) . . . . .	.5-19	Exhaust Vent (Lavy) . . . . .	.5-25
Charging via Shoreline Connection . . . . .	.5-19	Hydronic Heating and Hot Water System . . . . .	.5-26
Charging via Generator . . . . .	.5-19	Heater and Water Heater Operation -	
Charging via Alternator . . . . .	.5-20	Shore Power . . . . .	.5-26
Charging via Solar Power . . . . .	.5-20	Water Heater Only Operation - Shore	
Charging the Chassis Battery . . . . .	.5-20	Power . . . . .	.5-26
Multiplex System . . . . .	.5-20	Heater and Water Heater Operation -	
Systems Controlled By Firefly . . . . .	.5-20	Boondocking . . . . .	.5-26
Multiplex Home Screen/Monitor Panel . . . . .	.5-21	Water Heater Only Operation -	
Multiplex Secondary Screens . . . . .	.5-21	Boondocking . . . . .	.5-27
Multiplex Remote Controls . . . . .	.5-22	Storage Mode . . . . .	.5-27
Multiplex Bluetooth® App . . . . .	.5-22	Safe Operation . . . . .	.5-27
Cleaning the Multiplex Touchscreens . . . . .	.5-22	Maintenance . . . . .	.5-27
Ceiling and Directional Lighting . . . . .	.5-22	Microwave Ovens . . . . .	.5-27
		Refrigerator . . . . .	.5-27
		Operation . . . . .	.5-27
		Start up . . . . .	.5-27
		Defrost and Cleaning . . . . .	.5-27



## General Information and Cleaning

The interior of each Airstream Touring Coach has been designed for comfort, convenience, durability, and appearance. How you use it and how you take care of it, naturally, depends on you. However, if you learn to operate the interior components and take care of them and the touring coach properly, this knowledge will add to your pleasure, as well as the long life of your touring coach. All material should be professionally dry cleaned to remove any overall soiled condition.

### Upholstery

Regular cleaning and vacuuming are the best ways prevent excess dirt from accumulating. To help extend the life of the fabric, wipe up spills as soon as they occur. Clean soiled areas with mild soap and water, rinse with fresh water and wipe dry with a clean cloth.

For food and other common mild stains, wipe the affected area with a soft cloth or soft bristle brush using a non-abrasive household spray cleaner. Rinse with fresh water and wipe dry. For tougher stains, clean the soiled area with a 50% solution of Isopropyl Alcohol and water. It is important to rinse the cleaned area with fresh water after applying the alcohol solution.

To disinfect, apply a 20% solution of household bleach and water or a 70% solution of Isopropyl Alcohol and water. After the appropriate contact time, gently wipe or rinse with fresh water and dry the surface.

For an extensive guide to cleaning and removing tough stains, visit <https://www.nassimi.com> to locate their Resilience Vinyl Cleaning and Disinfecting Guide.

### NOTICE

**Do not use orange cleaner, abrasive cleaners or abrasive sponges/pads as these may damage the upholstery.**

### Cabinets, Overhead Lockers, and Countertops

Clean the high-pressure laminate surfaces with a clean, damp, non-abrasive cotton cloth and a mild liquid detergent or household cleaner. Rinse with clean water and dry the surface with a soft, clean, non-abrasive cotton cloth. Avoid flooding the laminated areas, especially near seams, since water can penetrate and cause the substrate to swell.

### NOTICE

**Do not use abrasive cleaners or abrasive sponges/pads. Never use cleaners containing acid or alkali. These cleaners will damage laminate surfaces.**

### Aluminum Interior Skin

The metal interior skin on the ceiling has a baked-on acrylic coating. Use soft rags or wash mitts, always moving lengthwise with the aluminum grain. NEVER rub hard on the coating. Remove oil, grease, dust, and dirt by washing with a 5 percent solution of commonly used commercial and industrial multi-purpose detergent in water. A thorough clean water rinse should follow cleaning. Drying the metal with a chamois or a soft cloth may prevent spots and streaks. When washing or waxing the metal, always wipe “with” the metal’s grain. A good grade of nonabrasive automotive paste or liquid wax once a year will increase the life of the finish.

### NOTICE

**Abrasive polishes or cleaning solvents such as automatic dishwasher or acid etch cleaners are too strong and should never be used. Rinse all grit from surface prior to washing. Use soft rags always moving lengthwise with the grain. NEVER rub with excessive pressure on the coating. Even the softest rag will damage the coating if excessive pressure is applied.**

### Sinks

Cleaning can be accomplished using a mild liquid detergent on a soft cloth. Avoid using abrasive cleaners and sponges/pads.

### Luxury Woven Vinyl Floor

#### General Cleaning

One of the best ways to keep the floor looking good is to vacuum regularly. This action helps prevent dirt from becoming embedded in the flooring and eliminates the need for more vigorous cleaning. Use a vacuum cleaner with strong suction and soft brushes that loosen the dirt while removing it simultaneously.

For general or light cleaning, sweep or vacuum off loose dirt and wipe down the floor. Prepare a solution of water and mild soap using mild liquid dish soap or a mild household cleaner. Using a soft bristle brush to clean, apply a small amount of the mixture. Rinse thoroughly to remove all soap residue. Allow the floor to air dry.

Remove stains as soon as possible to avoid staining. For spot removal, the largest portion of the spill should be removed by blotting or wiping up. During this step, avoid applying so much pressure that the stain spreads. Blot watery spills with a clean cloth or paper towels to remove them. Solid spills should be scraped

using a blunt scraper, brushed with a medium-bristle brush to loosen the embedded material, and vacuumed to remove the solid particles. Semi-solids (soft foods, mud, etc.) should be allowed to dry, then brushed with a medium bristle brush and vacuumed away.

After removing the spill, treat the rest with a general spot cleaner. It can be sprayed directly on the spill, worked in with a brush for 1 to 2 minutes, and blotted away. When the stain is fully removed, spray a small amount of water on the area and blot to remove the water with a paper towel.

Depending on the level of traffic, the flooring may require a deeper cleaning. Hot water extraction is recommended to clean the floor effectively if this occurs. For an extensive guide to cleaning and removing tough stains, visit <https://infinitylv.com> to locate their care and cleaning resources.

### **Interior Doormat and Rug Selection**

To avoid staining or discoloration of vinyl flooring, only use doormats or rugs made of natural fibers.

#### **NOTICE**

**Rubber or latex-backed mats or furniture with rubber feet may stain or discolor vinyl flooring.**

#### **NOTICE**

**Remember to protect the area around your flooring if using a bleach solution. Other fabrics may have an adverse reaction to certain cleaners.**

#### **NOTICE**

**The use of certain cleaning agents, including but not limited to powdered abrasives, solvents, and industrial strength cleaners is not recommended. Always follow the manufacturer's instructions. Check that the cleaner is suitable for use with cushioned vinyl floor coverings.**

### **Window Coverings**

Pull anywhere along the edge of the covering to remove. The coverings can be rolled up and held in place by the straps at the top, or they can be removed and stowed.

To clean window coverings, prepare a mixture of lukewarm water (approx. 30° C / 86° F) and a mild detergent (e.g., dishwashing detergent). Do not use rough, abrasive sponges/pads or any cloth that could leave marks, lint, or other residues on the fabric, such as paper towels.

Make sure your hands are clean before touching or handling the fabric. With one hand, gently push the fabric from the back against the spot you want to clean. Gently rub the area with a sponge until the spot has disappeared. Use a clean, wet cloth to remove detergent residues; wipe dry with a soft cloth if necessary. Leave coverings hanging in the down position to ensure it is completely dry before rolling it up again.

### **Wet Bath**

To enter the wet bath, slide the tambour door along its track to open. Use warm water and liquid detergent to clean your wet bath. Do not use abrasive cleaners; they may scratch and dull the surface of the fiberglass portions of the unit. Remove stubborn stains with solvents such as turpentine, paint thinner, or acetone. Restore dulled areas by rubbing with an automotive-type liquid cleaner, and then apply a light application of liquid wax to regain the soft sheen. **DO NOT** wax the shower bottom as it may become slippery, leading to a fall.

#### **⚠ WARNING**

**Applying wax to the base of the shower floor is not recommended, as this could create an unsafe surface.**

### **Shower Head**

The shower head is designed to give maximum flexibility in usage, and provides for water-saving techniques when using your touring coach on self-containment. It can be held in the hand and moved about the body. Normally, the best water conservation procedure is to wet the entire body and then turn the water off. Apply soap, lather thoroughly, and then rinse the soap off.

## Toilet

The toilet in your Airstream is a design that has been used for many years.

To flush, press the foot pedal, holding the pedal down until all solids have cleared. To add water into the bowl, press the pedal down halfway.

### NOTICE

**When you dump the bowl of the toilet, make sure all paper and solids have cleared the slide mechanism before you allow it to close. Failure to do so can cause the groove for the slide to become jammed and the slide will no longer close completely.**

Please see the toilet owner's/user manual for warranty, user tips, and maintenance information.

## Deodorizers and Biological Chemicals

There are many deodorizers and processing chemicals on the market in tablet, liquid, and powder form. These not only combat odor, but also stimulate the bacteria that works to dissolve the solids and tissues in your waste tank. These chemicals should be introduced through the toilet prior to use per the manufacturers directions. It's also important to always add a few gallons of water by filling the toilet bowl a few times and depressing the foot pedal.

## Lavy Fold Down Sink



Mounted on the wall above the toilet is a fold-down sink. To open, pull the top of the hinged sink outward until the bowl releases from the holding pegs and lower it into position. Lower the fold-down faucet and use the knob on the side to adjust the water flow. Water flows out the back of the bowl to a drain in the wall. Dry the bowl before folding it back up to keep the surface clean and reduce the chance of residue buildup.

## Faucets

### Lavatory Fold Down Faucet



Airstream Part #602954

Dehco - Model 231020

### Galley Faucet



Airstream Part #602898

Dehco - Model 231012

### Faucet Cleaning and Care

All that is needed to clean your faucet is a soft, damp cloth. Airstream does not recommend the use of scour pads, cleansers, or chemicals. The abrasive nature of these substances could damage the faucet's finish. A non-abrasive car wax will help to protect the finish.

## Storage

### Cabinets, Roof Lockers, and Cubbies

Latching hardware keeps doors and drawers secure while traveling. To open doors and drawers equipped with secure latching hardware, press the spring-loaded knob inward until it pops out to use as a pull. When closing, push the knob back into the recess until the mechanism latches.

The cubbies near the side entrance have easy to clean rubber mat linings covering the bottom that can be used for stowing shoes as you enter the door.

Exercise caution when storing items in cubby spaces and other open storage areas as they could dislodge during travel. Heavy items could cause damage and even be dangerous should they dislodge while making sudden stops. Always secure cargo before travel. It is recommended to store heavier items in lower storage areas and lighter items overhead.

### **⚠ WARNING**

**Unsecured cargo can cause injury or lead to a vehicle accident and may damage the coach's interior should it become dislodged.**

### **⚠ WARNING**

**Keep flammable material away from appliances with burners and do not block vents.**

### Towel Hooks and Key Holder

Next to the side entry you will find pegs for holding keys and hanging pet leashes. Remove items hung in this area prior to operating the vehicle as they could fly forward during a sudden stop.

You will also find two fold out towel hooks flush-mounted on the exterior of the lavy. Each hook has a 40lb. MAX weight capacity.

### L-Track Cargo Rails and Molle Panel Storage

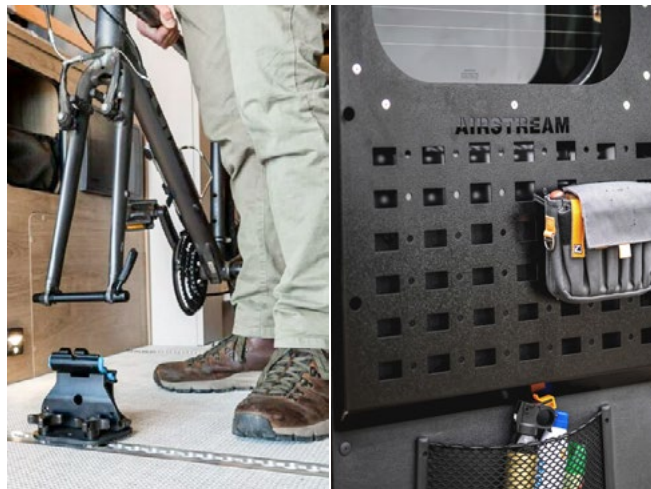

Your coach has L-track rails (airline-style cargo track) on the floor of the bed area. This high-grade aluminum track is durable and lightweight and creates strong and secure tie-down anchor points when equipped with L-track fittings.

On each of the two rear doors, you will find Molle panels. Popular with outdoor enthusiasts, Molle panels provide a customizable mounting surface to hold travel gear. The rear passenger-side door also has a bottle opener.

 A wide range of fittings and accessories can be purchased and installed aftermarket. Visit <https://airstreamsupplycompany.com> by scanning this QR code where some products are available. Enter L-track in the search field to find attachments like the L-track quick-release latch or the L-track bike mounting system (shown above left).

### **NOTICE**

**Each Molle panel has a 30 lb. MAX weight limit.**

## Driver and Passenger Seats

The driver and passenger seats are a component of the Ram Promaster van. Airstream reupholsters them to match the interior decor.

Several adjustments are available around the base and sides of both seats. Adjust the driver's seat to suit your comfort level and to a position where you can easily reach and operate the controls when driving. Adjustments include lumbar, recline, forward/rearward, swivel (if equipped), and height. To learn how to use them, refer to the Ram Promaster Owner's manual seat section.



If equipped, the swivel seat lever is on the lower front inboard side of both seats. Pull the lever outward to unlock the swivel and turn the seat to face the opposite direction. The seat will lock in both the forward and rearward-facing positions. Before operating the vehicle, check that the seats are locked in the forward-facing position by attempting to rotate them on their swivel.

### NOTE

Some models will not shift out of park unless the seats are facing forward and locked into position. The instrument cluster may also provide audible and visual warnings. Refer to your Ram Promaster Owner's manual for information about these and other notifications in the swivel seat section.

### ⚠ WARNING

Do not operate the vehicle unless the seats are locked in the forward-facing position.

### ⚠ WARNING

Adjust the driver's seat so that you can easily reach and operate all controls. Make sure the seat is locked in position. Do not make adjustments to the driver's seat while vehicle is moving. The seat could move unexpectedly causing loss of control.

### NOTICE

Seat backs in cab must be returned to full upright position and seat moved forward before the seat is swiveled. Failure to do so could result in damage to the seats upholstery, wall panels, seat base trim, and seat controls.

## Second Row Bench Seat

Second-row seating allows two additional passengers to be onboard when traveling. Below the seat is a storage compartment, two 120 VAC receptacles, and 4 USB ports. The bench seat also has integrated child seat anchors and tethers as part of the LATCH system. For more information on how to use the LATCH system, see [How to Install a LATCH Equipped Seat on page 8-5](#).

## Folding Bed and Access Step



### **Folding Bed Operation**

To unfold the hinged metal bed frame and mattress:

1. The folded bed is held in place by brackets with velcro straps. Lift the edge of the mattress to locate the velcro securing straps at both ends of the bed frame and undo them.
2. Lift the frame out of the holding brackets and unfold it until it lays flat.
3. Lower the frame into position by aligning the catches on the roadside frame with the holes on the curbside frame.

To fold the bed up, repeat the process in reverse and ensure the securing straps are velcroed back in place before traveling.

### **Bed Access Step**

Use the integrated roll-out step next to the lavatory to access the raised bed. The bed step rolls out directly on the floor to support the user's weight and also opens and doubles as storage. The step has an L-shaped drawer stop on the side that engages when the step is pulled out. Lift up on the drawer stop to disengage.

### **⚠ WARNING**

To avoid injury and damage to the folding bed, do not exceed the maximum weight limit of 600 lbs.

### **NOTICE**

Fold and secure the bed with the velcro straps prior to operating the vehicle. Failure to do so could result in the frame being damaged.

### **⚠ WARNING**

Keep your furniture and family safe from fires caused by careless smoking. Do not smoke when drowsy. Remove immediately any flowing ash or a lighted cigarette which falls on furniture. Smoldering or smoking material can cause upholstered furniture fires.

## Pop-Top



The optional pop-top offers additional sleeping capacity for two and includes three screened windows, a fan, efficient LED lighting, USB charging ports, and a 3" mattress.

Prior to use, ensure that wind speeds are not forecasted to exceed 25 MPH. The maximum weight limit of the pop-top interior is 550 lbs.; the max weight of the ladder is 250 lbs.

### **⚠ WARNING**

**Do NOT use the pop-top in wind speeds above 25 MPH. To avoid injury to occupants or damage to the coach, do NOT use the pop-top if stormy weather is forecasted.**

### Opening the Pop-Top

1. Unfasten the travel safety straps found at the front of the roof access.
2. Locate and unfold the ladder (stored in the overhead above the driver and passenger seats). Attach the ladder to the hooks at the entrance to the pop-top. Ensure the ladder's feet are in contact with the floor.
3. Climb the ladder to reach the release button and unlock it with the provided key.
4. Press the release button while pushing upward on one of the grab-handles to unlatch the top, then hold onto both handles and push upward to raise the top.

### **⚠ WARNING**

**To avoid injury or damage to the pop-top components, do not exceed the following weight limits: pop-top interior - 550 lbs./ladder - 250 lbs.**

## Closing the Pop-Top

1. Turn off and close the ceiling vent.
2. To avoid damaging the top, close all windows, turn off all lights, remove all personal items including bedding and pillows, disconnect and remove all USB powered devices, and ensure the canvas is completely dry prior to closure.



3. Locate the two front straps on either side of the front window (interior). Connect the two straps, and pull taut to 45 7/8" across the canvas width, as shown above.

### **NOTICE**

**A loose front strap can result in possible damage to the canvas when the pop up is closed. Keep the front strap drawn taut to protect the canvas from possible damage when closing the pop up.**

### **⚠ CAUTION**

**Moving parts can pinch, crush or cut. Keep clear and use caution.**

4. Pull downward on both grab-handles evenly until the top is lowered but do NOT completely close the pop up at this point. Observe the canvas as you lower the top. Make sure it folds inward to avoid getting it caught in the pop-top's mechanism or latch.
5. Walk around the vehicle and visually inspect the roof for any canvas material sticking out of the frame. If necessary, carefully tuck in any protruding material.
6. Fully close the top. Pull down on the handles until the latch engages. A clicking sound should be heard, signifying the locking system has engaged. Lock the mechanism and remove the key.

## Interior

Perform the following to ensure the pop-top's locking system is engaged: grab the handles with both hands and push upwards. If the upward pressure does not change the tops position significantly on both sides, then the locking system is properly engaged.

7. Fasten the travel safety straps.
8. Fold and secure the ladder in the compartment above the driver and passenger seats.

### NOTICE

**To avoid damaging the top: close all windows, turn off all lights, remove all personal items including bedding and pillows, disconnect and remove all USB powered devices, and ensure the canvas is dry prior to closure. Check that the top is fully latched and locked, and fasten the safety straps prior to operating the vehicle.**

### ⚠ WARNING

**When travelling with the top closed, do NOT exceed the pop-top's 80 MPH MAXIMUM SPEED LIMIT. Do NOT drive with the pop-top open; components may be damaged. Never drive with people or pets inside the pop-top sleeping area.**

### Cleaning and Sealing

Periodically clean the canvas to prevent soil build-up. Use a soft brush, sponge, or clean cloth to remove dirt from the fabric before washing. Clean the canvas with a soft cloth, water, and a small amount of mild soap to prevent damaging the water repellent treatment. Allow the canvas to fully dry prior to closing the top.

It is recommended to inspect and treat the canvas of the pop-top once a year. Apply a high-quality seam sealant following the sealant manufacturer's instructions. Once the sealant is dry, a water repellent spray like Kiwi® Camp Dry can be applied to the canvas if needed. Allow the canvas time to dry before closing the pop-top.

The exterior roof of the pop-top can be treated as a part of the vehicle when washing and waxing. Ensure the top is closed prior to washing the vehicle. Use a weak jet stream of water; do not pressure wash.

### NOTICE

**Test all products being applied in a non-conspicuous area. Do not use harsh soaps or detergents. Canvas must be completely dry prior to closing to avoid damage to the canvas.**

### Pet Amenities



Airstream designed your Rangeline with your pet in mind. You will find a pet drawer under the refrigerator with no-spill bowls for food and water, with storage underneath for towels and other pet supplies.

The area under the human bed is designed for placement of a pet bed. Outside the coach mounted to the running board, you will find a paw-shaped leash holder/tie-out.



## Table



The table has several adjustments to suit your needs.

To adjust the table forward and backward:

1. Locate the clip on the underside of the tabletop near the wall track. The tab resembles a light switch.
2. Use your finger to pull the tab and unlatch the clip so the table is free to slide on the track
3. Position the table as needed. Return the table to a latched position before operating the vehicle.

To open the table extension:

1. Locate the springloaded black pull knob next to the table leg on the underside of the tabletop.
2. Pull the knob until the extension rotates and adjust to the desired position.

### **⚠ WARNING**

**Do not travel with the table unsecured or unlatched as it could become dislodged posing a danger to the driver and passengers. Check that the table is locked by attempting to move it on its slide.**

## Electrical System Overview

### Power Center

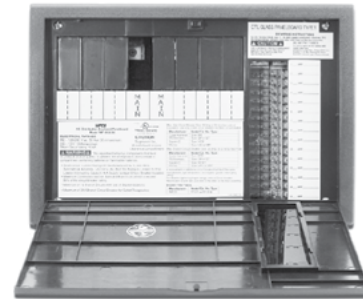

The Power Center is a self-contained 120 Volt AC (VAC) power distribution center utilized in recreational vehicles. It houses the coach's circuit breakers and fuses. Its primary function is to provide circuit protection for all the 120 VAC loads in the touring coach and is central to the overall electrical system.

The Power Center distributes 120 VAC power to appliances and receptacles. Converter/Inverter output is routed through the breaker box to provide load safety protection. It also distributes 120 VAC to the converter, which converts 120 VAC to 12 Volt DC (12V) to power 12V systems.

The Power Center distributes incoming power from three sources: Shoreline power when connected to an external 120 VAC power supply (city power), onboard generator power, and the 270Ah 12V LiFePO4 Deep Cycle House Battery via the 12V DC to 120 VAC AC inverter.

The Power Center is located next to the wardrobe on the face of the roadside bed base. Open the decorative door to access 12V fuses and 120 VAC breakers.

### **⚠ WARNING**

**The power center is a centralized power switching, fusing, and distribution center. The potential of lethal electrical shock is present in this box. Inadvertent shorts at this box could result in damage and/or injury. All servicing of this box should be done by a qualified Service Technician.**

### **⚠ WARNING**

**Disconnect/De-energize all main power service, shore power, generator power, and inverter power prior to servicing the breaker panel.**

## **Circuit Breaker Protection**

Standard residential-style (resettable) circuit breakers provide circuit protection for all 120 VAC loads. Airstream has installed breakers per RVIA (NEC) listing requirements for the touring coach.

The 30 amp main breaker feeds individual branch breakers. The branch-breakers protect individual loads, which are identifiable by the affixed labels. Shutting off the main breaker will remove power to all branch loads (except for outlets/receptacles on the inverter circuit when the inverter is enabled, see GFCI this page).

A circuit breaker's ON/OFF switch function operates like a light switch: up is ON, and down is OFF. If an overload or short occurs, the breaker will snap to the OFF position to protect the connected circuit. As a result, any device running on the circuit will lose power. Before attempting to reset the breaker, consider the cause. If a connected device is faulty or uses a higher amperage than the circuit breaker's capacity, turn it off before resetting the breaker.

Before resetting the breaker, you need external AC power going to the breaker box. Firmly push the breaker switch to the OFF position and back to the ON position. If the breaker snaps back to the OFF position while resetting, a fault condition still exists and should be serviced by a qualified Service Technician. Suppose the breaker stays ON but snaps back OFF after turning on a possibly faulty appliance. In that case, a fault condition may exist in that appliance that will require service by a qualified Technician.

## **Ground Fault Circuit Interrupter (GFCI)**

The GFCI breaker provides reliable overload and short-circuit protection. GFCI breakers protect against ground faults and provide additional safety to the occupants of the touring coach on all outlets/receptacles. A ground fault occurs when current travels along an unintended path to ground, possibly through water or a person, which may result in an electric shock. The GFCI compares the amount of current going to and returning from the device plugged into the circuit's outlet/receptacle. When the amount of current going to the device differs from the amount returning, the GFCI interrupts the current within a fraction of a second, removing power from the circuit, and protecting the user.

Each GFCI circuit breaker is calibrated to trip with a ground current of 5 mA or more. Since most people can feel as little as 2 mA, a shock may be felt. The shock should be of such a short duration that the effects would be reduced, less than what would

normally be a dangerous level. However, persons with acute heart problems or other conditions that can make a person particularly susceptible to electric shock may still be seriously injured.

While the GFCI circuit breaker affords a high degree of protection, there is no substitute for knowing that electricity can be dangerous when carelessly handled or used without reasonable caution.

The system incorporates GFCI breakers that implement an auto-self-test functionality. When turned off, these breakers require external AC power to be present before they can be turned back on. If power is present, and the breaker refuses to stay on, consult an electrician or certified RV technician.

## **⚠ WARNING**

**The GFCI circuit breaker will NOT reduce shock hazard if contact is made between a HOT load wire and a neutral wire or two HOT load wires. GFCI circuit breakers provide protection only to the circuit to which it is connected.**

## **GFCI Breaker Test**

Perform this test on the GFCI circuit breaker each month and record the date.

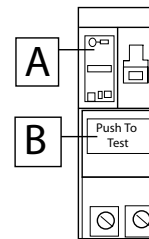

1. With handle A in the "ON" position, press PUSH TO TEST button B.
2. Handle A should move to the TRIP position, indicating that the GFCI breaker circuit is open.
3. Move handle A to the "OFF" position and back to the "ON" position to restore power.

If the device remains on when the Test button is pushed, the GFCI is not working properly or has been incorrectly installed (wired improperly). If your GFCI is not working properly, call a qualified, certified electrician who can assess the situation, rewire the GFCI if necessary, or replace the unit.

## **Fuses**

When blown, the fuses housed in the power center will be illuminated by a blown-fuse LED indicator to help determine which fuse needs replacing. The indicator

will only illuminate if the affected circuit remains closed and/or has a load. For example, suppose a light is burned-out or the switch to the light is off, resulting in an open circuit. In this case, the fuse will not illuminate.

## NOTICE

**Most fuses will require a qualified technician to access and replace. Contact your dealer or Airstream Service Center.**

### 120 volt System

#### City Power Overview

120 VAC shoreline power (city power) enters the coach through the SmartPlug Cordset shoreline connection, Smartplug inlet, and distribution panel, where it is distributed to each appliance or receptacle. The 120 VAC electrical system provides power to operate the A/C, hydronic heating element, appliances, converter, and 120 VAC receptacles for portable appliances.

The inverter/charger converts shoreline 120 volt alternating current (120 VAC) to direct current (DC) power to charge the battery pack and diverts 120 VAC shore power to 120 VAC systems.

All wires, components, and wiring methods meet federal and state requirements. The wiring is protected by circuit breakers when connected to external AC power. The circuit breaker panel for the 120 volt system is inside the Power Center; [see Power Center on page 5-11](#).

If an outlet or appliance is not working, check your touring coach circuit breakers and the breaker at the shoreline connection. If a breaker continues to trip after you have reset it several times, your circuit may be overloaded with devices/appliances, or there may be a short in the circuit. The Energy Management System (EMS) should shed loads to prevent breakers from tripping. Ensure the Power Source on the Multiplex electrical screen matches your incoming power source. If all else fails, try lessening the load on the circuit by turning off devices while using external appliances like vacuum cleaners. If that does not solve the problem, consult an Airstream Service Center.

## NOTICE

**Do not connect shoreline to a 240 VAC outlet. Connecting to a 240 VAC outlet may result in permanent damage not covered by warranty.**

### Outlets and USB ports

There are several outlets with 120V receptacles inside and outside of your coach. At the base of the second row seating you will find an outlet with USB charging ports



The galley countertop has a retractable flush-mounted popup outlet with 120V receptacles (to plug in the cooktop and other appliances/devices) and USB charging ports. Press down on the top to pop the outlet out of the countertop socket and raise it to lock into the extended position. To close, press the black tab at the bottom to release the lock while pressing down to close and lock in place. The outlet is self-contained and sealed should any spillage occur around its casing. However, use the same caution you would with any electrical outlet; [see Electrical Appliances and Outlets on page 2-2](#).

## NOTE

**The popup outlet is the only outlet the cooktop can be plugged into. The popup outlet is controlled by the EMS and was designed with cooktop use in mind. Depending on use of other 120 VAC appliances and outlets, temporary interruptions in service may occur; [see Energy Management System \(EMS\) on page 5-14](#).**

## Energy Management System (EMS)

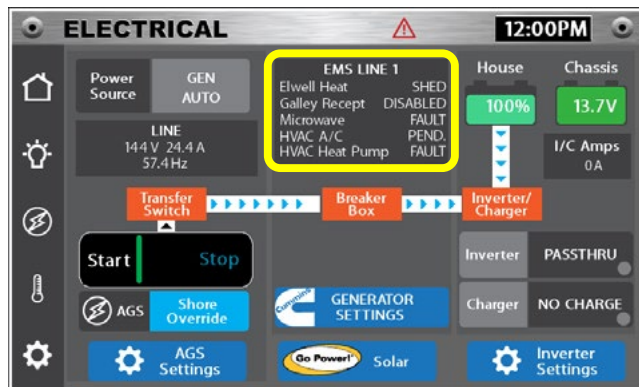

Screen images may vary slightly with continuous improvements/firmware updates

The Energy Management System (EMS) is a function of the Firefly Multiplex system. The electrical screen of the central Multiplex panel (example above) displays EMS data.

The system monitors the total current draw of the coach's 120 VAC power system. When running multiple appliances or turning on devices like coffee makers and vacuums, the system will temporarily shed other loads (reduce/throttle back power from certain devices) like the heating/hot water electric element to prevent nuisance breaker tripping.

Upon decreasing the additional demand, and approximately 2-3 minutes pass, the system will automatically power up appliances and components in reverse sequence.

Load shedding occurs in the following sequence depending on the demand:

1. DC converter output is throttled to control the converter AC input current requirements
2. Heating/Hot Water System Electric Element
3. Air Conditioner Compressor
4. Microwave
5. Cooktop (Galley Popup Outlet)

The number of appliances and devices the system can run simultaneously depends upon available power. With a 15A shore connection, you may be limited to one or two appliances before the EMS will begin to shed loads.

Navigate to the electrical screen on the multiplex touchscreen panel to view Power Source and EMS data; see [Multiplex System on page 5-20](#).

## 12 Volt System

State of Charge (SOC) is the primary concern when using only battery power (boondocking) from the onboard battery pack. SOC is displayed in percentages on the home screen and electrical screen of the Multiplex panel.

Everything except the A/C, hot water electric element, outlets, cooktop, and microwave runs on 12 volt power (note: some of these appliances have 12 volt electronic boards and require 12 volt power to operate).

Power is routed from the house battery to the 12 volt distribution panel and through its branch circuits to the rest of the touring coach. All 12 volt current is routed to a 12 volt fuse block. Power from the fuse block goes to a busbar holding Type 2 thermal breakers. The thermal breakers feed electrical components throughout the touring coach.

### **CAUTION**

**Thermal breakers break contact when overheated by a short or overload in the wiring. These breakers automatically reset when cooled down. A breaker continually overheating and breaking contact should be investigated by a qualified service technician.**

### **NOTE**

**The engine battery and house battery are isolated from each other, preventing the two systems from drawing down simultaneously.**

## Solar System

The rooftop solar panel installed on your Airstream helps maintain battery charge of both the house and chassis batteries. The solar system's solar charge controller gathers energy from the solar panel and stores it in your batteries.

To optimize solar charging, ensure the panel is clean and not shaded by trees or structures that might block the sun. Please refer to your owner's packet for reference material that discusses the solar system and its operation.

To view solar power information select the Go Power icon from the Multiplex electrical screen; also see [Charging via Solar Power on page 5-20](#) and see [12-Volt Main Schematic on page 9-13](#)

## Electrical System Operation

Your touring coach has a powerful 270Ah 12V LiFePO4 (Lithium Iron Phosphate) Deep Cycle House Battery, a 100 Amp Charger, a 2,000 Watt True Sine Inverter and vehicle alternator. These components work in conjunction to provide a seamless experience whether hooked up to shore power, boondocking on battery power, or driving to the destination.

The information in this manual touches on the highlights of the system, its components, essential functions, and operation. Before operating the system review the Inverter/Charger and Battery information in your Owner's Packet for important warnings/limits, operating instructions, and tips for using the battery. Visit Battle Born's website for more information: <https://battlebornbatteries.com>

### Battery Disconnect Switch



The battery disconnect switch is behind the left rear door and must be on to charge the battery and/or operate the various electrical systems in the coach.

Rotate the knob to the right and left to turn the power to your coach on and off.

#### NOTICE

**Do not over rotate the battery disconnect switch. Over rotating can damage the switch rendering it inoperable, resulting in power loss.**

## House Battery



 A single 270Ah Battle Born Gamechanger 3.0 house battery provides onboard power. It is housed under the roadside bed base.

The following is an overview of the battery and battery management system. Please read the Battle Born Gamechanger 3.0 manual (in your Owner's Packet) to learn more about using and maintaining the battery. For additional information, scan the QR code above to visit <https://battlebornbatteries.com/> and navigate to the Gamechanger 3.0 information page.

Lithium-ion batteries are superior to traditional lead-acid batteries in many ways. They provide longer life, faster charging, more usable energy, and have a lifespan of approximately 3000-5000 cycles.

A full discharge and recharge of the battery defines a cycle. The number of cycles a lithium-ion battery can sustain varies depending on its usage. A battery that is consistently discharged to only 50% SOC will have more cycles than a battery that is frequently discharged to 0% SOC.

To learn about the various methods of charging the battery, see [Battery Charging on page 5-19](#).

#### **WARNING**

**The battery manufacturer's manual in your owner's packet contains detailed operating instructions and important safety information. Please read the manual before using the battery.**

## Battery Management System (BMS)

The BMS is an internal component of the battery and is crucial to ensuring safe operation. The BMS monitors cell voltages, currents, and temperatures to ensure they operate in a safe range and will shut the battery down should any faults occur. The following are features of the BMS:

- Over/under voltage protection
- High current protection/short circuit
- High-temperature protection
- Low-temperature charging protection
- Cell balancing

## High Voltage Disconnect

If an individual cell voltage exceeds a prescribed threshold during charging (approx. 14.7V), the BMS will prevent a charge current from continuing. Discharge is always allowed under this condition.

### NOTICE

Even though the BMS will protect against issues from overcharging, it should be avoided. The recommended specs are 14.2-14.6 bulk/absorb and below 13.8 float.

### NOTE

If the battery has not been balanced for a long period, a high voltage disconnect could occur at a lower voltage. The battery will rebalance after several full charges.

## Low-Voltage Disconnect

If an individual cell falls below a prescribed threshold during discharge (approx. 10.5V), the BMS will prevent further discharge. Should this occur, connect the coach to external power using the shoreline power cord to bring the battery out of the low-voltage disconnect and fully charge the battery. Bringing a battery out of low-voltage disconnect only “wakes” the battery and allows it to accept a charge. Without shore or generator power, the battery may go back into low-voltage disconnect.

### NOTICE

The manufacturer states you should charge (wake) your battery within 24 hours of entering low-voltage disconnect; otherwise, you risk damaging the battery and voiding the warranty.

## Temperature Limits

- The battery has an operating temperature range of -4°F (-20°C) to 135°F (57.2°C).
- The BMS will not allow a charging current under 25°F (-3.9°C) but will continue to discharge down to -4°F (-20°C).
- The BMS will not allow a charging or discharging current if the internal temperature of the battery has reached 135°F (57.2°C)

## Cold Weather Usage

The house battery has internal heaters that will engage when the battery temperature drops below 35°F (when the battery disconnect switch is ON). Depending on the temperature, the heating element will automatically engage and disengage and does not require any user input.

### NOTE

The BMS will not allow a charging current if the internal temperature is below 25°F, and it will not allow charging or discharging current above 135°F.

### NOTE

If the battery is in low-voltage disconnect mode and the battery temperature is below 35°F, the heat function will need some time to warm the battery before performing the wake-up procedure.

## Inverter/Charger

The inverter/charger converts direct current (DC) battery power to alternating current (AC) power to run the microwave and power outlets on the inverter circuit (identified by the affixed “Inverter Circuit” label). The inverter must be on to use appliances and outlets unless connected to a generator or shoreline power.

The inverter/charger also converts shoreline AC power to DC power to charge the battery.

The inverter will draw a small amount of power when turned off; however, the power consumption will be even greater if left on. Turn the inverter off to conserve battery power when not in use.

### NOTICE

**Airstream calibrates all settings at the factory and recommends adjustments not be made.**

### NOTE

**Overloading the inverter will cause an automatic shutoff to activate. Removing the load will allow the inverter to reset.**

### ⚠ WARNING

**An extensive owner’s manual for the Inverter/Charger is provided in the Airstream Owner’s Packet. Make sure to read, understand, and follow all information, Notes, Cautions, and Warnings in the manual before operating the Inverter/Charger.**

## Generator

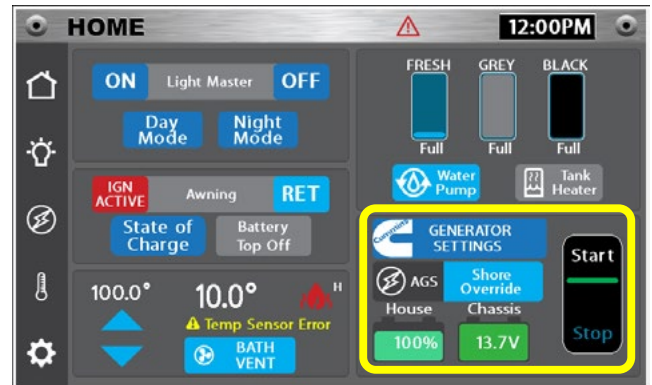

The onboard gasoline-powered generator makes your RV house electrical system fully self-contained. It allows you access to 120 volts when no shore power is available. The user controls all generator functions via touchscreen input at the Multiplex panel; see [Multiplex System on page 5-20](#).

To START the generator: press and hold START for at least 1 second.

The system functions automatically upon starting the generator or upon enabling the Automatic Generator Start System (AGS).

Because the generator uses fuel from the gas tank, there is no need for a secondary fuel source. Upon reaching the 1/4 tank level, the generator will stop running to reserve enough fuel to get to a refilling station.

### ⚠ DANGER

**Do not operate the generator in an enclosed building or a partly enclosed area such as a garage. Nor should the generator be operated while sleeping. Follow all instructions and warnings in this manual and the generator manufacturer’s manual.**

### ⚠ WARNING

**Exposure to carbon monoxide, moving parts, and electricity hazards are possible due to unexpected starting of generator while in Auto Start mode.**

### NOTE

**It is easier on your generator and appliances if you allow the generator to reach its normal operating speed (about a minute) before applying heavy current loads.**

## Automatic Generator Start (AGS)

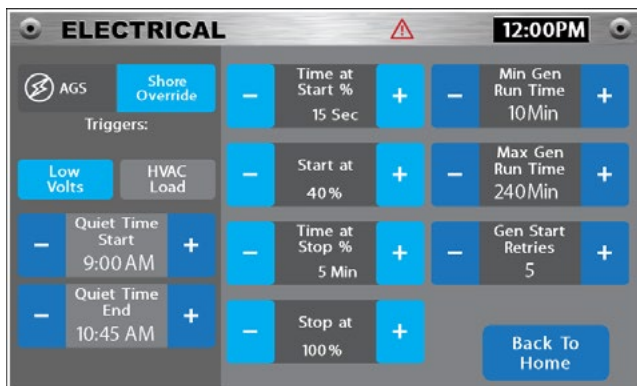

The Automatic Generator Start System (AGS) provides optional automatic control of your onboard generator. The purpose of an AGS system is to automatically start and run the generator to charge the battery when the State of Charge (SOC) drops to a predetermined level. This feature protects the battery by ensuring it never discharges to the point of a low-voltage disconnect. Once the battery receives a sufficient charge, the generator will automatically turn off.

To change generator start/stop settings and to set predetermined quiet times so the generator will not start during the night or during posted quiet times, navigate to the electrical screen on the Multiplex touchscreen panel; [see Multiplex System on page 5-20](#).

### NOTE

**The system will only allow the generator to run until the battery reaches a 95% SOC to avoid running the generator indefinitely.**

Once enabled, AGS will remain enabled until you cycle the Ram ProMaster Ignition, disengage the AGS, or until you manually operate the generator.

The generator produces Carbon Monoxide (CO), a highly poisonous gas. Moving Parts and electricity can cause severe personal injury or death. To reduce exposure to these hazards, always disable AGS before:

1. Sleeping in the vehicle, unless equipped with a working Carbon Monoxide detector
2. Parking the vehicle in a garage or confined space
3. Parking the vehicle for storage
4. Servicing the generator, battery or other electrical appliances
5. Fueling the vehicle

## Automatic Transfer Switch



Your coach is equipped with an Automatic Transfer Switch with shore power sensing capability that automatically switches the 120 volt feed to the Energy Management System from shoreline to generator and back without input, as you choose which way to power the touring coach.

The Automatic Transfer Switch automatically determines the shore power connection amperage, which means no manual setting is necessary.

In addition, the Automatic Transfer Switch protects against the following:

- Power Surges
- Open ground
- Open neutral
- Low (<102V) and high (>132V) voltage
- Reverse polarity
- Miswired pedestals
- High and low frequency
- Multi-mode surge suppression

### ⚠ WARNING

**Make sure to read and understand all electrical Component owner's manuals provided in the owner's Packet before operating the touring coach. Observe all operating instructions and Warnings as well as all recommended maintenance schedules and procedures.**



## Battery Charging

### State of Charge (SOC)

Because runtime varies based on demand and environmental factors, the best way to ensure enough battery power remains is to monitor the State-of-Charge (SOC) on the Multiplex home screen or electrical screen. SOC is displayed as percentages on the battery icon; for more information, [see Multiplex System on page 5-20](#).

The two most significant loads on the battery are heating and cooling. The more these systems run, the more energy consumption.

If the inverter use is extensive, the house battery will deplete much quicker. Even when not using 120 VAC power, the inverter will draw a small amount of power if left on. When not in use, turn the inverter off to conserve battery power. Consider reducing the temperature on the thermostat when using the heater and increasing the temperature on the thermostat when using the air conditioner. If you plan on staying longer without access to a charge, you will want to conserve your battery power by using as few lights and appliances as possible.

### Charging via Shoreline Connection

The first step is making sure the battery disconnect switch is on. It must be on for the battery to charge. Plug the Smartplug Cordset (shoreline power cord) into an external shoreline power supply (city power). Check that the cordset LED indicator light is blue and plug the other end into the coach's roadside SmartPlug inlet; [see Shoreline Power Inlet and Cordset on page 6-7](#).

The 30A automatic transfer switch with shore power sensing capability provides total electrical protection from faulty external power sources. It also automatically determines the shore power connection amperage, which means no manual setting is necessary; [see Automatic Transfer Switch on page 5-18](#).

In some older parks and other locations where three-pronged outlets are not available, certain precautions to ensure proper grounding and polarity must be taken. These precautions are listed below:

1. Attach the three-pronged plug to a two-pronged adapter. The third conductor line of this adapter has a short wire lead that must be grounded.

2. For proper grounding, connect the short ground lead to a grounded outlet box or to a cold water pipe. When no water pipe is available, drive a metal rod two feet into the ground and attach the ground lug to it, thus providing the unit with proper grounding.

### NOTE

**When the three-pronged plug can be used, there will be no problems with proper polarity or grounding with a properly-wired shoreline outlet.**

As an RV owner, you may want to install a 30A 120 VAC outlet in your home so you have a shore power hookup readily available. However, you must have the proper outlet installed. Typical household 30A outlets are wired 240 VAC for home appliances. **RV outlets are 30A 120 VAC.** Ensure your electrician is aware of the difference, or they may mistakenly wire the outlet to 240 VAC.

### NOTICE

**Do not connect to a 240 VAC outlet. Connecting to a 240 VAC outlet may result in permanent damage not covered by warranty.**

### Charging via Generator

The first step is making sure the battery disconnect switch is on. All generator functions are controlled via touchscreen input at the Multiplex panel. There are a few options for charging the battery using the generator, the simplest of which is to select BATTERY TOP OFF from the home screen of the Multiplex panel.

Selecting the battery top-off icon starts the generator and runs it until the battery reaches a 95% Start of Charge. For additional information on generator operation and charging using the generator, [see Generator on page 5-17](#).

### NOTE

**The system will only allow the generator to run until the battery reaches a 95% SOC to avoid running the generator indefinitely.**

## Charging via Alternator

The first step is making sure the battery disconnect switch is on. The vehicle alternator will provide a charge to the house battery. All switching is handled automatically so one need only drive the coach to provide a charge. Charge times will vary depending on current SOC and environmental factors.

## Charging via Solar Power

The solar charging system is primarily used to help maintain a charge between shoreline or alternator charging. The solar system is automated and does not require input from the user. To view solar power information select the Go Power icon from the Multiplex electrical screen. The battery disconnect switch will need to be in the on position for the system to accept a charge from the solar panel.

The solar panels will not provide any charge to the batteries if the battery disconnect switch is off. For information about how the system switches between charging the house and chassis battery; [see Charging the Chassis Battery on page 5-20](#).

### NOTE

**The solar panel and charge controller are designed to help maintain a battery charge, and are limited in their ability to provide a charge to the battery. Additionally, the solar panel will not provide any charge to the batteries if the battery disconnect switch is off.**

## Charging the Chassis Battery

There are several ways the chassis battery gets charged. It can be charged by connecting to shoreline power or running the generator. Both these methods maintain the chassis battery charge with an integrated trickle charger. When the engine is running, the alternator charges the chassis battery.

It can also receive a charge from the solar system. The solar system's solar charge controller automatically prioritizes charging the chassis battery (over the house battery) until the chassis battery reaches a certain voltage. It then switches solar charging to the house battery and back again if the chassis battery voltage falls below a certain level. When another charging source is present, the solar charge controller will sense the high chassis battery voltage and switch solar charging to the house battery.

## Multiplex System

The Firefly Multiplex System provides advanced automation and mobile electrical solutions for your touring coach. Firefly is a multiplex network system that combines multiple signals across a media to reduce wires and simplify end-user control. The system combines all desired functions and controls of the touring coach into a simple touchscreen interface that allows you to control many systems. The following information is an overview of the basic functions of the Multiplex System. Please refer to the manufacturer's user guide included with your owner's packet for detailed information on the use of this system.

Each icon illuminates when pressed, indicating the circuit is either on or off. When making selections, the display's various touch controls will change from white **OFF** to blue **ON**. Selections controlling circuits such as Light Master and Panel Lights typically do not change from white to blue.

## Systems Controlled By Firefly

- Generator
- Inverter
- Bath Vent Fan
- Solar
- All lights (inside and outside)
- Climate
- Tank monitoring (fresh, black, grey tanks)
- Battery State of Charge
- Tank heaters
- Water pump
- Energy Management System (EMS); [see Energy Management System \(EMS\) on page 5-14](#)

### NOTE

**The Multiplex System is self-resetting should a circuit trip. The owner should never need to reset the system for any reason. If the main control panel or remote panels are not operating, this could indicate a short in the wiring that will require service by a certified technician.**

## Multiplex Home Screen/Monitor Panel

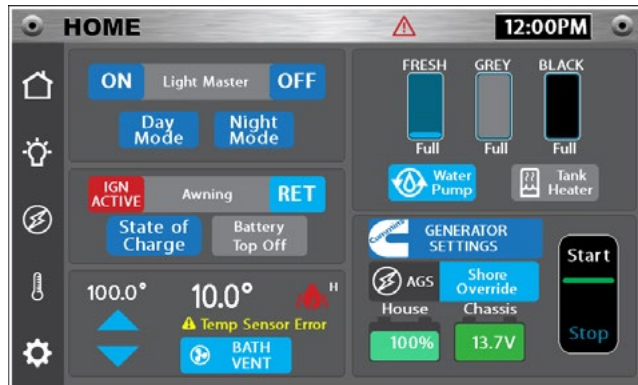

Screen images may vary slightly with continuous improvements/firmware updates

The Home screen displays fluid levels of the Fresh Water, Grey water, and Black Water tanks. All fluid monitoring systems are factory calibrated to the tank capacities of each model. Sender pads are installed and adhered to the sides of the holding tanks. The sender pads scan the level through the tank wall using the sender's microprocessor programming.

The Home screen also displays the status and settings of the major systems of the touring coach, including the voltage status of the House and Chassis battery.

### Multiplex Secondary Screens

The navigation bar on the left side of the screen allows you to select from the four secondary screens: Lights, Electrical, Climate Control, and Settings (see next page for examples). From here, you can navigate to additional screens that serve a variety of functions and provide detailed system monitoring information.

## NOTICE

**You may encounter Warning screens when entering settings. Some Changes will affect functions of the touchscreens and your touring coach and should only be changed by a trained technician.**

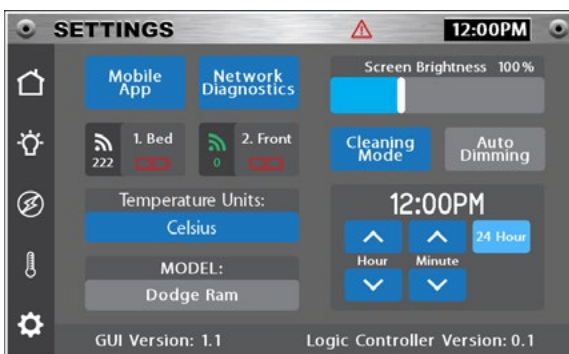
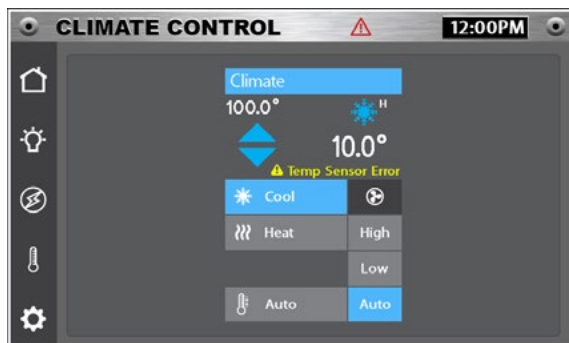
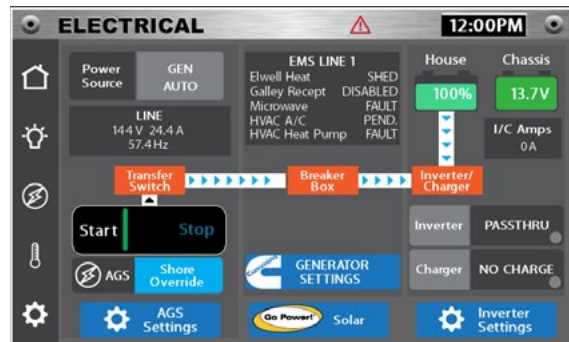
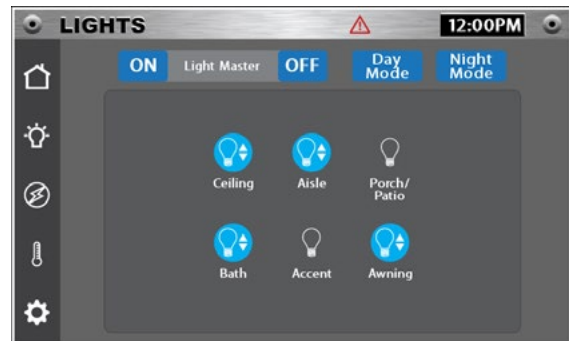

Screen images may vary slightly with continuous improvements/firmware updates

## Multiplex Remote Controls

In addition to the multiplex touchscreen panel, your airstream includes two RF remote controls. The smaller removable remote control is velcro attached to the inside of the top cubby storage compartment at the side entrance. The larger fixed controller is on the roof locker next to the microwave and easily accessible from the bed.



## Multiplex Bluetooth® App

The multiplex system can be controlled wirelessly via Bluetooth® connection using the Vegatouch Mira app while in proximity to the touring coach. To download the app and connect via Bluetooth®:

1. Go to the settings screen on the multiplex panel inside your touring coach and tap the gear icon.
2. Select “mobile app” to reach the Mira information page where the required PIN is displayed.
3. Scan the QR code, download the app, and follow the on-screen instructions to connect using the PIN.

If you are unable to scan the QR code, search your app store for Mira, or select one of the following icons:



## Cleaning the Multiplex Touchscreens

To clean the glass surface of the LCD touchscreens, power down the system and then gently wipe it with a soft, slightly damp cloth (using ONLY minimal amounts water or lens cleaner). Ensure the LCD is fully dry before powering the system up again.

### NOTICE

**The components of the Firefly system must not be exposed to liquids or moisture of any kind (including the use of any cleaning agents). The only approved exception is cleaning of the glass surface of the LCD touchscreen.**

## Ceiling and Directional Lighting



Under-cabinet lights are turned on and off by pressing the light on the lens. These lights also drop down to allow directional control.

The Multiplex System touchscreen controls the LED lighting throughout your Airstream. The “Home” and “Lights” screens have a “Light Master” switch that will allow you to instantly turn all the interior lighting in your touring coach, on or off.

Light Master Memory Feature:

The Light Master function has a memory. If you turn off individual lights and then press Light Master OFF, it will recall what lights were on the next time you press Light Master ON, and only those lights will come on. Hold the Light Master ON for more than 1 second to reset the memory and turn on all the interior lights.

Light Master **LOCK** Feature:

If Light Master OFF is held or pushed twice, the Light Master On will not respond. Hold the Light Master ON to resolve.

### NOTICE

**Since your Airstream has LED lighting, there are no lights to change. If an LED light stops functioning, it will require service or replacement.**

## Entertainment Systems

### Wireless Bluetooth® Speaker



Above the galley, you will find a removable/portable and rechargeable Bluetooth® speaker housed in a springloaded bracket. Bracket tension is adjustable with the included wrench (mounted to the underside). Refer to your owner's packet for instructions on how to connect to and use the speaker.

A secondary speaker mount is located on the curbside exterior of the touring coach and functions the same as above.

### Cordless Phone Charger/Holder



Your Coach has a cordless phone charger on the side of the pantry, roadside, near the bed. With both a stationary and adjustable arm, your phone can be secured or removed with one hand. The rotating feature allows the phone to be mounted vertically or horizontally, depending on the user's preference. The charger also has a holder for an additional phone and a USB port for corded charging.

## TV and Antenna Prewire

Your Rangeline has been pre-wired to allow for the addition of an optional TV and over the air TV antenna. Contact your Airstream dealer for additional information on cost and installation.

## Airstream Connected, Wi-Fi

 Your Airstream comes pre-wired to have an aftermarket Airstream Connected Wi-Fi kit installed. For more information, scan this QR code or visit <https://www.airstream.com/connected/>. Stay connected to the amenities you demand with a boosted Wi-Fi signal or a dedicated 4G LTE-A internet service (requires data plan activation). Contact your preferred dealer's service department to schedule your installation.

## Appliances

All appliances are delivered to Airstream, Inc., with in-depth owner's manuals. Those manuals are included in the delivery case supplied by your dealer. The manuals may contain Warnings, Cautions, and operating instruction that should be read and followed before operating the appliances.

The information contained in the appliances manuals supersedes any information contained in the Airstream Rangeline Owner's Manual on appliances. If you believe contradictory information on appliances is contained in this manual, or if any appliance manual(s) have not been provided with your vehicle, contact your dealer, the respective appliance manufacturer, or Airstream Customer Service at 937-596-6111 or write:

Airstream Factory Service Center

428 W. Pike Street

P.O. Box 629

Jackson Center, OH 45334-0629

(937) 596-6111

## Maintenance

Follow the instructions and Warnings noted in the respective appliance and equipment owner's manuals, as well as those mentioned below.

## Air Conditioner

In your owner's packet is a set of literature covering all operating and maintenance instructions. If the literature is misplaced, contact the A/C manufacturer or your Airstream dealer for replacement. All air conditioner functions are controlled using the touchscreen multiplex panel.

Proper voltage to the A/C is critical. A volt meter check may find voltage much lower at a campground shoreline outlet than the needed 110 to 120 volts. Your A/C may not function if the voltage is too low. Low voltage is usually associated with older or poorly maintained motorhome parks. Parking your touring coach so the power cord can be plugged in to a receptacle close to the fuse or circuit breaker box can alleviate low voltage problems. Avoid extension cords and adapters whenever possible. If an extension cord must be used, it should be rated at 30 amps and as short as possible to provide the most current.

If high temperatures are expected, make an effort to park in a shaded area. Starting the A/C early in the morning also helps. It is more efficient to hold a comfortable temperature than it is to lower the temperature after the interior of the touring coach is already hot.

### NOTICE

**It is recommended to clean filters weekly when A/C is in full use. Review the air conditioning literature supplied in your owner's packet before proceeding.**

## Cooktop

Your airstream has a single burner induction cooktop stowed in the top galley drawer. The countertop popup outlet is the only outlet the cooktop can be plugged into (see note below).

Because the cooktop is induction, it will only work with cookware with magnetic properties (ferrous metal), including cast iron and steel cookware. Aluminum, copper, and other non-ferrous metal cookware will not work.

A magnet is included with the cooktop to help determine if your cookware will work. Hold the magnet to the bottom of your cookware to tell if it is compatible. If the magnet clings to the underside, the cookware will work. If the magnet only slightly sticks, it may not work well. If there is no pull on the magnet, it does not contain the ferrous metal needed for induction and will not generate heat. Refer to the manufacturer's directions in your owner's packet for additional information.

### NOTE

**The popup outlet is the only outlet the cooktop can be plugged into. The popup outlet is controlled by the EMS and was designed with cooktop use in mind. Depending on use of other 120 VAC appliances and outlets, temporary interruptions in service may occur; see [Energy Management System \(EMS\)](#) on page 5-14.**

**Ceiling Vent Fan**



It is recommended to use the ceiling vent fan to remove hot air from inside the touring coach when the outside temperature does not require air conditioning or when cooking to remove smoke, steam, and other cooking fumes and odors. The ceiling vent fan can create a balanced airflow by opening a window during operation, allowing fresh air to be drawn in while hot, stuffy air is exhausted. The fan has a built-in rain cover that protects it from rain, whether the fan is on or off.

**Operation**

1. Pull down the knob to unlock the lid. Rotate the knob to open or close the vent. Push up on the knob to lock the lid.
2. Press FAN ON; continue pressing the button to cycle through the four fan speeds. Press FAN OFF to turn the fan off.

**NOTE**

**The fan is designed to be fully opened or fully closed when the vehicle is moving.**

**Ceiling Fan Mode**

With the fan motor running, close the lid to enter Ceiling Fan Mode. The fan will continue to run and circulate air.

**Cleaning Instructions**

1. Turn the fan motor off and remove power by turning off the battery disconnect.
2. Rotate the screen retainers to remove the screen.
3. Clean the screen with a mild soap and water solution, air dry, and reinstall.

**⚠ CAUTION**

**Do not operate the fan with the screen removed as this could result in damage or injury.**

**NOTICE**

**Never place Lindeen™ or a similar cover over the ceiling fan. Greatly restricted airflow and increased sound levels will occur.**

**NOTICE**

**Do not use petroleum containing additives or solvent based products on any of the vent's components. The use of non-compatible chemicals will cause cracking and product failure.**

**Exhaust Vent (Lavy)**



The lavy/bath exhaust vent (shown above) removes moisture from the air and should be turned on when using the shower. The vent fan can be turned on and off from the home screen of the multiplex panel.

## Hydronic Heating and Hot Water System



Your Touring Coach has a gas/electric hydronic heating and on-demand hot water system that runs on gasoline and an electric element, eliminating the need for LP gas. The system gets its fuel from the vehicle's gas tank.

### NOTE

**The system will automatically shut OFF if the Coach's fuel tank reaches the one-quarter level, leaving enough fuel to travel to a refilling station.**

The heater portion of the system operates by circulating a heat transfer fluid (RV boiler antifreeze) through quiet air handlers that provide soft, radiant heat to warm the Coach's interior. When the Coach is cold, the fans run on high until the interior temperature reaches its target. The fans then automatically slow down to maintain comfort levels.

The water heater portion of the system circulates the same fluid through an instantaneous water heat exchanger, which produces hot water for showers and faucet use.

The Timberline touchscreen display (shown above) controls the system. When making selections, the display's various touch controls change from blue **OFF** to orange **ON**.

The controls allow you to adjust the heat and whether you want to utilize gasoline and/or electric:

- The **HEATER** icon controls the gasoline burner
- The **ELEMENT** icon controls the 1500W electric element that only functions when connected to shoreline power

See your Owner's Packet for a copy of the Timberline User Manual, where you will find detailed operation, maintenance, and troubleshooting instructions. Or, visit Timberline's website: <https://timberlineheat.com>

## Heater and Water Heater Operation - Shore Power

When both the HEATER and ELEMENT icons are selected, the system automatically prioritizes using heat from the electric element. If there is greater heating demand on the system, the gasoline burner will automatically engage and heat the antifreeze for circulation.

The gasoline powered HEATER should only be operated when the vehicle is outside.

1. Select ELEMENT to activate the electric heating element (conserves fuel while connected to shoreline); and/or:
2. Select HEATER (prioritizes electric element and allows the system to engage the gasoline powered heater based on demand).
3. Select ZONE 1 (bed area) or ZONE 2 (all other areas) using the tabs at the bottom of the screen.
4. Select the ON/OFF icon to turn the heat on or off for the selected zone.
5. Use the sliders to adjust the system to your desired temperature for each zone. The top slider adjusts daytime temperatures. The lower slider sets nighttime temperatures. Times for day and night can be adjusted in the settings menu.

## Water Heater Only Operation - Shore Power

1. Select ELEMENT to activate the electric heating element (conserves fuel while connected to shoreline); and/or:
2. Select HEATER (prioritizes electric element and allows the system to engage the gasoline powered heater based on demand).

## Heater and Water Heater Operation - Boondocking

The gasoline powered HEATER should only be operated when the vehicle is outside.

1. Select HEATER.
2. Select ZONE 1 (bed area) or ZONE 2 (all other areas) using the tabs at the bottom of the screen.
3. Select the ON/OFF icon to turn the heat on or off for the selected zone.
4. Use the sliders to adjust the system to your desired temperature for each zone. The top slider adjusts daytime temperatures. The lower slider sets nighttime temperatures. Times for day and night can be adjusted in the settings menu.



### Water Heater Only Operation - Boondocking

1. Select HEATER to turn on the water heater.

**NOTE**

**When boondocking, the Element icon will change color when selected, but will not function unless connected to shoreline power.**

### Storage Mode

You can place the system in storage mode for short-term storage between trips. For information on how to use storage mode, see the Timberline User Manual provided in your Owner's Packet.

### Safe Operation

DO NOT run the hydronic heating/hot water system in an enclosed building or a partly enclosed area such as a garage where exhaust fumes can accumulate and create unsafe conditions.

For information on the safe operation of this system read the Timberline User Manual provided in your owner packet, and also, [see Gasoline Powered Generator and Hydronic System Safety Information on page 2-7.](#)

### Maintenance

The Hydronic Heating and Hot Water System requires periodic maintenance. For information about maintaining this system read the Timberline User Manual provided in your owner packet, and also, [see Maintenance Schedule on page 9-2.](#)

**⚠ DANGER**

**DO NOT run the hydronic heating/hot water system in enclosed buildings or a partly enclosed area such as a garage where exhaust fumes can accumulate and create unsafe conditions; [see Gasoline Powered Generator and Hydronic System Safety Information on page 2-7.](#)**

**⚠ WARNING**

**Carefully read all the manufacturer's instructions prior to operating. NEVER store flammable material in close proximity to the exhaust outlet on the side of the touring coach. Hot exhaust system components can cause burns if touched, even briefly.**

**NOTICE**

**To prevent equipment damage, the hydronic water heater should only be started after the water system is primed and ready for use.**

### Microwave Ovens

Refer to the microwave user manual provided in your owner's packet for information on microwave operation.

### Refrigerator

Your Airstream is equipped with a 12V refrigerator. The front panel of the refrigerator is a dry-erase marker board. Use only dry-erase markers and wipe the surface clean regularly to avoid staining. Review all refrigerator literature supplied in your owner's packet or stored in the refrigerator prior to operating it.

### Operation

All units are supplied with a wide range thermostat designed to sense the evaporator (cold plate) temperature. The coldest position on the thermostat is reached by turning the knob to the right (clockwise); conversely turning the thermostat knob to the left (counterclockwise) yields a warmer setting. The OFF position is reached by turning hard counterclockwise past the click.

### Start up

Turn the power on and set the thermostat between 3 and 4. You can make further adjustments to suit your personal requirements after the box has cooled down. Allow the refrigerator to come down to temperature before loading with product. Adding pre-cooled product will help keep the temperature stable when loading. Setting the thermostat to a higher setting e.g., 7, will not decrease the time required for the unit to cool down to its normal operating temperature.

### Defrost and Cleaning

The frequency of defrost is dependent on the number of door openings, the ambient temperature and the humidity level. Typically, it is a good practice to defrost once there is ¼ inch of frost buildup on either side of the evaporator (cold plate). When defrosting, the unit is shut off by turning the thermostat counterclockwise to the OFF (0) position. Prop the door open. We suggest placing a towel in the bottom of the refrigerator to catch excess moisture.

Now that the unit has been defrosted, the interior can be cleaned with a non-abrasive cleaner. Do not use "Brillo" or "SOS" type abrasive pads, as they will score the surfaces. Baking soda is recommended.

**NOTICE**

**Speeding up the defrost process with a knife or scraper is strongly discouraged due to the likelihood of rupturing the refrigerant circuit.**



# AIRSTREAM®

## Section 6 EXTERIOR

EXTERIOR CARE . . . . .	6-2	AWNING . . . . .	6-8
How to Care for Your Touring Coach Finish . . . . .	6-2	Awning Operation . . . . .	6-8
Washing Your Touring Coach . . . . .	6-2	Manual Awning Operation . . . . .	6-8
Waxing/Polishing Your Touring Coach . . . . .	6-3	Care and Maintenance . . . . .	6-9
ROADSIDE EXTERIOR COMPONENTS . . . . .	6-4	Cleaning your Awning . . . . .	6-9
CURBSIDE EXTERIOR COMPONENTS . . . . .	6-5	SCREEN DOORS . . . . .	6-9
EXTERIOR FEATURES . . . . .	6-6	Sliding Screen Door . . . . .	6-9
Windows . . . . .	6-6	Rear Screen . . . . .	6-10
Gravity Water Fill . . . . .	6-6		
Water Service Compartment . . . . .	6-6		
Sprayer Port . . . . .	6-6		
City Water Hookup . . . . .	6-7		
Black Tank Flush (San-T-Flush) . . . . .	6-7		
Shoreline Power Inlet and Cordset . . . . .	6-7		
SmartPlug Inlet . . . . .	6-7		
SmartPlug Cordset . . . . .	6-7		
Suspension Enhancements . . . . .	6-7		

## Exterior Care

Please refer to the Ram ProMaster manual for information on maintaining the bodywork. Airstream provides the following additional information to help you understand the finish and its care. Following these instructions will provide a long-lasting, high-gloss finish for your recreational vehicle.

### NOTICE

**Airstream's information on finish care may provide additional information and tips on the use of the Ram ProMaster Van as a touring coach; however, no information about the exterior finish of your touring coach in this manual should be interpreted as advice or directions to disregard or void the warnings, cautions, or other information contained in the Ram ProMaster's manuals.**

### How to Care for Your Touring Coach Finish

Keeping your touring coach looking its best always involves keeping the paint finish clean and in good condition. It is essential to wash and polish periodically; should the paint finish ever be damaged and need repair, do so as soon as possible. The purpose of the paint finish is twofold:

- Provide an aesthetically pleasing appearance.
- Protect the vehicle from the environment.

Your touring coach is exposed to many environmental conditions that have an adverse effect on the paint finish:

1. Road salts and sodium chloride
2. Road tar/bugs
3. Bird droppings/tree sap
4. Industrial fallout/acid rain/pollution
5. Ultraviolet exposure and moisture

The most common problems resulting from these conditions are corrosion, staining, and chemical spotting. Minimize these issues by regularly-scheduled washing and polishing.

Regularly check the caulking and sealant used in external seams and joints, such as window frames, light bezels, beltline, and rub-rail molding. If this material has dried out and becomes cracked or checked, or if a portion has fallen out, it should be replaced with fresh material to prevent possible rain leaks. Caulking and sealing material is available from your touring coach dealer and most RV supply stores.

## Washing Your Touring Coach

The first step to caring for the exterior should always be to wash the surface prior to applying wax or polish. Ensure the touring coach's surface temperature is not too hot, under 90°F, and not in direct sunlight. A shady area is ideal for washing your vehicle, as direct sunlight causes water and soap to evaporate too fast, resulting in water spots. Use a mild soap or detergent.

Most auto care stores carry a car wash shampoo. Avoid combination wash-n-wax products, as these waxes cause buildup. Have two dedicated sponges or wax mitts: one for the paint finish and one for the wheels and undercarriage. Brushes or wash mitts with plastic bristles are acceptable for use on tires and wheel wells but not intended for use on the paint finish. Avoid using such items on painted surfaces, as they will damage the touring coach paint and finish.

Wash the wheels and wheel wells first, preventing splattering on already clean panels. Using a different sponge/wash mit, wash the body from the top and work your way down, frequently rinsing to minimize grit abrasion. Follow with a final rinse of water. This process will remove most contamination from the touring coach's surface. For stubborn stains such as road tar, use an ammonia-based glass cleaner or a small amount of rubbing alcohol on a damp cloth. These products may not dissolve the road tar but will loosen tar and bug stains and remove them from the surface. Do not use solvent-based cleaners on bird droppings or tree sap as these are water-based stains and will eventually dissolve using an ammonia-based glass cleaner, warm soapy water, and a little "elbow grease." Rinse with clean water.

Drying the touring coach is just as important as washing your vehicle as today's tap water and well water contain many chemicals that could water stain your touring coach's finish. We suggest using a damp natural or synthetic chamois. However, other drying products, such as lint-free micro-fiber towels, work just as well.

### NOTICE

**When using a power washer with a round jet nozzle, maintain a proper distance of approximately 2.2 feet; 1 foot when using a 25 degree flat spray jet nozzle. Never point the jet nozzle at moldings, hoses, exhaust pipes, electrical components, seals, or plug connections. Never use round jet nozzles on tires, the pulsating water can damage the sub-structure of tires.**

### Waxing/Polishing Your Touring Coach

Over 90 percent of all automotive finishes are clear coat finishes that protect the base coat paint/pigment (the pigmented layer that provides color). You are washing and polishing a clear urethane coating when caring for the bodywork. Since the clear coat finish is a protective layer, it must be maintained, especially in harsh environments. Clearcoats do not fade themselves but appear to fade or lose gloss as the surface becomes contaminated by the environment. You must remove this contamination frequently, or it will result in a dull or low-gloss finish. Occasional washing alone will not adequately remove some forms of contamination, so polishing is necessary.

Polishes and waxes primarily serve the following purposes:

6. To remove minor surface imperfections caused by water spots and acid rain
7. To remove minor scratches by filling them and leveling the surface
8. To beautify the paint finish appearance with more depth and high-gloss
9. To protect the paint finish from the elements

#### **NOTICE**

**Do not use products that contain harsh abrasives such as rubbing or polishing compounds. These products should only be applied by experienced technicians with the proper training and equipment. Always wash before applying waxes or polish. Failure to do so could result in damage to the clear coat.**

Most polishes and waxes are designed to clean and polish in one application. A hand-applied polish or wax will offer outstanding performance and protect the touring coach finish. When applying polish or wax, do so in a shaded area making sure the surface is at the specified temperature according to the polish manufacturer's recommendations. Due to the variations of polishes and waxes, incorporate the following suggestions into the polishing technique:

1. Condition the polishing pad by rubbing a slight amount of polish on it.
2. Use only the amount of polish specified in the label directions.
3. Work a small area at a time.
4. Rinse off and remove dried polish from crevices, trim, and moldings.
5. Follow the products manufacturer's directions.

# Exterior

## Roadside Exterior Components

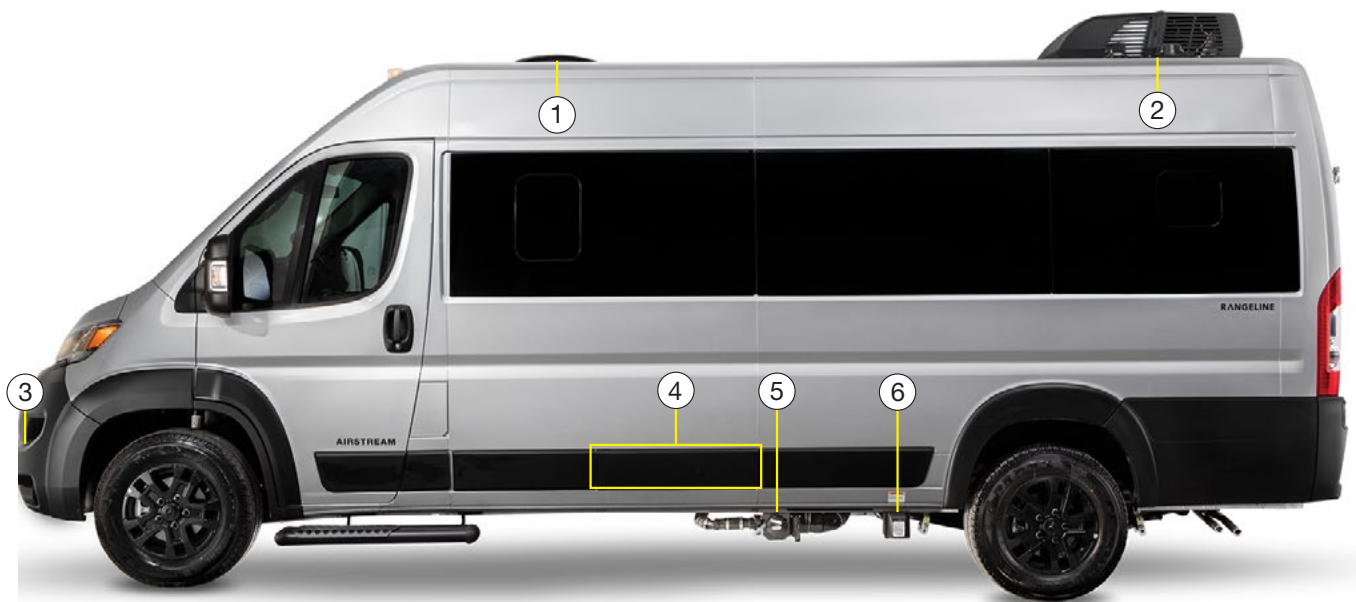

### NOTE

Sections 6 and 9 contain additional information about these components. Mid-production changes may affect the exact location of the features shown above.

1. Ceiling vent fan; [see Ceiling Vent Fan on page 5-25](#).
2. Rooftop air conditioner; [see Air Conditioner on page 5-24](#).
3. Front bumper foot well step; for cleaning windshield (250 lb. MAX).
4. Water service compartment - contains sprayer port, city water fill, black tank rinse, and a courtesy light; [see Water Service Compartment on page 6-6](#).
5. Black tank dump valve; [see Drain and Waste System on page 9-8](#)
6. SmartPlug power cord inlet; [see SmartPlug Inlet on page 6-7](#).

### Curbside Exterior Components



#### NOTE

Sections 6 and 9 contain additional information about these components. Mid-production changes may affect the exact location of the features shown above.

- |   |  |
|---|--|
| <ol style="list-style-type: none"> <li>1. Awning; <a href="#">see Awning on page 6-8</a>.</li> <li>2. Awning support brackets; <a href="#">see Awning Operation on page 6-8</a>.</li> <li>3. Exterior outlet, 120 Volt AC.</li> </ol> | <ol style="list-style-type: none"> <li>4. Paw-shaped leash holder/tie-out; <a href="#">see Pet Amenities on page 5-10</a>.</li> <li>5. Front bumper foot well step; for cleaning windshield (250 lb. MAX).</li> <li>6. Speaker Mount; <a href="#">see Wireless Bluetooth® Speaker on page 5-23</a>.</li> </ol> |
|---|--|

## Exterior Features

### Windows

To open the window above the second-row seating or the window above the bed, depress the red button, and the springloaded silver latch will pop up, allowing them to slide open. Upon closing the window, push the silver latch button down until it clicks and locks back into place.

Clean your touring coach windows the same way you clean the windows in your home. Clean the seals with a damp cloth and mild detergent every 3 to 6 months. Do not use strong solvents, as they will damage the seals. A coat of natural silicone lubricant applied after the seal has dried will keep it flexible. Spread the lubricant evenly with a brush or finger, working it into the surface. This is a good practice for all rubber seals in your touring coach.

### **⚠ WARNING**

Failure to properly clean and lubricate the window seals could result in the window sticking to the jamb and should only be released by a qualified technician trained in the procedure. Do not force, pry, or apply great pressure to open the window. Failure to heed this warning may cause the window to shatter and/or cause personal injury.

### Gravity Water Fill



The gravity water fill is behind the right-rear door. Owners sometimes fill their tanks with “home” water to avoid using water from sources that may be distasteful. However, the more water you carry in the fresh water tank, the less cargo carrying capacity you have for other items.

Before filling, run water through your hose for a short time and flush it out. To fill the tank:

1. Remove the cap and insert a high-pressure RV/ Marine FDA-approved drinking water hose of at

least ½-in. diameter made from material that is tasteless, odorless, and non-toxic.

2. Turn the water on at the water source to fill the tank. The small vent above the cap allows air to expel from the tank when filling.
3. Use the multiplex panel home screen to monitor the water level until the tank is full and shut the water off.

### **NOTICE**

Since the fresh water tank fill is essentially in the interior of the unit. Please monitor the amount of water you are putting into the tank to ensure that you do not have overflow into the coach as this could result in damage that cannot be covered by warranty.

### Water Service Compartment

Except for the Gravity Water Fill (shown left), the Water Service Compartment contains all other exterior fresh water inlets and outlets on the Rangeline.

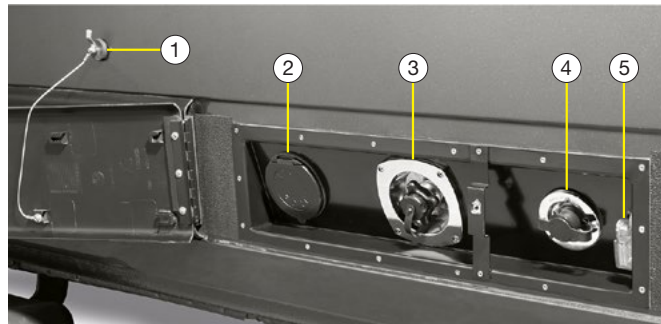

Water Service Compartment Features:

1. Magnetic door hold with rubber foot
2. Sprayer Port
3. City Watery Hookup
4. Blank Tank Flush
5. Courtesy Light (on/off switch is on the light)

### **Sprayer Port**

The sprayer port provides external water service allowing the connection of the quick connect fitting hose and sprayer nozzle. Water will flow from the onboard fresh water tank (when the water pump is on while boondocking) or city water when connected to a city water source.



### City Water Hookup

For consistent water flow and plumbing line safety, an in-line regulator limits pressure to 50 psi.

Use a tasteless, odorless, non-toxic, high-pressure hose of at least 1/2-in. diameter designed for touring coach use. The city water inlet is a standard garden hose thread. We suggest you carry two lengths of hose in order to reach hookups farther away than normal, as well as to have a spare.

After hooking up the hose and turning on the city water valve provided in the park, slowly open a faucet. There will be a lot of spurts and sputtering until all the air is expelled from the touring coach system. It may take some time before a steady flow of water occurs. Once a steady flow reaches the first faucet, open the others long enough to expel the remaining air.

### Black Tank Flush (San-T-Flush)

For information on how to use the black tank flush and how to empty the gray and black tanks, [see Drain and Waste System on page 9-8](#).

### Shoreline Power Inlet and Cordset



### SmartPlug Inlet

Your Airstream is equipped with a SmartPlug power inlet located on the roadside exterior. Prior to establishing a connection, review the SmartPlug Cordset instructions that follow.

Features of the SmartPlug include:

- Eliminates Overheating - Increased pin & clip surface area improves conductivity during high demand.
- Ease of Use - The unique plug body shape and push-in design ensure a proper connection.
- Multi-Point Locking System - Side clips lock the plug securely into the inlet, eliminating stress on the pins.
- Weatherproof Seals - Multi-fin silicone gaskets installed in the inlet cover and interior of the plug body eliminate moisture penetration.

### SmartPlug Cordset

Before connecting power to your Airstream, plug the cordset (power cord) into the power pedestal and check the cordset's safe/unsafe LED indicator lights. If the red LED illuminates, do not plug the cordset into the SmartPlug inlet on your Airstream.

The cordset has a Reverse Polarity Indicator System with two LED indicator lights, one blue and one red. Reverse polarity occurs when connecting a cordset to a power pedestal that has the positive and negative leads reversed internally. A reverse polarity condition is unsafe, and it can damage an Airstream's electrical components.

Safe/Unsafe LED Signals:

- Blue ON, Red OFF - Normal Power, Safe
- Blue ON, Red ON - L1 and neutral are swapped in a reverse polarity condition, Unsafe
- Blue OFF, Red ON - L1 and ground are swapped in a dangerous reverse polarity condition, Unsafe
- Blue OFF, Red OFF - No Power

Many campgrounds provide less than 30 amp service, and your hookup may blow their fuse or circuit breaker. If this happens, reduce the load, replace the fuse, or reset the breaker.

### **⚠ WARNING**

**A reverse polarity condition is detected if the cordset's LED illuminates RED when connected to a power source. If this occurs, do not plug the cord into your Airstream. Reverse polarity is an UNSAFE condition that could result in bodily harm. It can also damage electrical components. This condition exists when the power pedestal is improperly wired.**

### Suspension Enhancements

Your touring coach has been outfitted with maintenance-free SuperSprings® helper springs and SumoSprings suspension components designed to increase the ride height, decrease vibration, stabilize sway, and soften harsh rebounds.

### **NOTICE**

**The SuperSpring helper springs were installed based on model design specifications and must not be adjusted. Adjustments would alter ride height and modify ride characteristics which may result in damage to undercarriage components.**

## Awning

### Awning Operation

The awning will extend and retract even when the sliding door of your van is open. The extendable support legs can either be placed on the ground (staked into place) or locked into support clips on the coach. See your owner's packet for the awning manufacturer instructions. Basic operation is explained below.

#### NOTICE

**Awning must be retracted before driving the Touring Coach. Damage may occur if the awning is not properly retracted.**

#### NOTICE

**If wind or extended periods of rain are expected, retract the awning. Secure for travel. The effects of wind and rain on any awning are unpredictable. Severe damage to the vehicle and or the awning may result and cannot be covered by warranty.**

#### NOTICE

**Never use the awning with damaged fabric. Make sure the awning can be correctly retracted. The awning should not be rolled up wet.**

### Manual Awning Operation

To extend and retract the awning:

1. Open the rear doors to retrieve the awning rod from above the door opening.
2. Loosen the tensioner on the awning rod, adjust to the desired length, and tighten.
3. Insert the "T" shaped end of the awning rod into the socket on the far left side of the awning. Twist the rod counterclockwise (~1/4-1/2 turn) to fasten the rod to the socket (the rod should now stay in place when let go).
4. Crank the rod clockwise until the awning is partially extended (~3-5 feet). Twist the rod counterclockwise again (~1/4-1/2 turn) so the rod hangs in place while you complete the remaining steps.

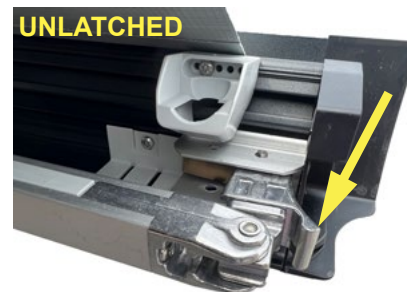

5. Unlatch the legs from the awning one at a time (as shown above) and fold them down. Upon pulling the latch, the foot of the leg will disengage from its support near the center of the awning.

UNLATCHED



LATCHED



6. Extend the legs to the ground a few feet in front of the awning (at an angle) so that the legs will be perpendicular to the ground when the awning is fully extended (as shown above).
7. Fully extend the awning until it begins to drape and then crank the rod counterclockwise until the awning is taut.
8. Readjust the legs to the desired height perpendicular to the ground, relatch the extension, and stake the legs to the ground.

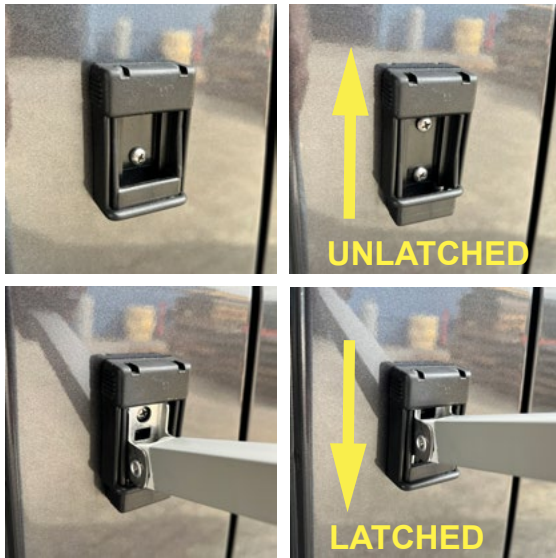

9. Alternatively, insert the feet into the awning support brackets on the side of the coach (as shown above) carefully so as not to damage the paint.
10. Remove the awning rod by pushing up and twisting right (~1/4-1/2 turn) until the “T” lines back up with the hole in the socket, allowing you to remove the rod from the socket.

**Care and Maintenance**

Periodic maintenance is necessary to keeping your awning working and looking like new.

**Cleaning your Awning**

Per the manufacturer, only clean the fabric with water or Thule PVC Cleaner.

The following items should be checked periodically:

- Regularly apply silicon oil to the hinge between the arm and the front profile.
- Check all mounting brackets are tight.
- Check all pivot points for enlargements of holes or broken rivets.
- Check end caps for cracking and splitting.
- Check that awning rail is tight against coach and all screws are tight.
- Check canopy for loose stitching and possible shrinkage or puckering.
- Clean and lubricate all tension knobs and pivot points.

**Screen Doors**

**Sliding Screen Door**



The sliding door has an accordion-style screen door to provide ventilation and insect control. To operate, carefully pull the screen from its stowed position across the opening. Reverse the procedure when returning the screen door to its stowed position. Always stow the screen door before operating the main sliding door to avoid damage.

<b>NOTICE</b>
<b>Check that the screen door is open before closing the exterior door. Failure to follow this caution could result in damage to the screen door.</b>

# Exterior

---

## Rear Screen



The rear screen is modular allowing the user to position, open, and close as desired. The edges are held in place with magnetic strips to allow for fast egress in an emergency. Push anywhere along the edge to open. The screen can be unzipped, rolled up, and held in place at the top by the attached straps, or it can be removed entirely and stowed.

# AIRSTREAM®

## Section 7 RAM PROMASTER VAN

IMPORTANT PROMASTER INFORMATION . . . . .	7-2	CHANGING A TIRE . . . . .	7-6
Fuel . . . . .	7-2	Flat Tire . . . . .	7-6
COMPONENT IDENTIFICATION . . . . .	7-2	Precautions When Changing a Wheel . . . . .	7-6
ProMaster Van - Serviced by Ram		Procedure . . . . .	7-7
ProMaster or Promaster Suppliers . . . . .	7-2	Jack . . . . .	7-7
Chassis . . . . .	7-2	INSTALLING AND REMOVING A WHEEL . . . . .	7-8
Airstream Components - Serviced by		Mounting a New Wheel. . . . .	7-8
Airstream Authorized Service Centers or		Centering Wheels With Wheel Fasteners. . . . .	7-8
Airstream suppliers. . . . .	7-2	Lowering the Vehicle. . . . .	7-8
Cab Area. . . . .	7-2	Wheel Bolt/Lug Nut Tightening . . . . .	7-8
Living Quarters . . . . .	7-2	TIRE ROTATION . . . . .	7-9
Electrical Components . . . . .	7-3	Rotation Pattern For Wheels. . . . .	7-9
Exterior . . . . .	7-3	Support . . . . .	7-9
TIRES . . . . .	7-3	Correct . . . . .	7-9
Vehicle Placard and Tire Inflation Pressure		Incorrect . . . . .	7-9
Label . . . . .	7-3		
Proper Tire Inflation . . . . .	7-4		
Cold Inflation Pressure . . . . .	7-4		
Underinflation . . . . .	7-4		
Tire Inflation Procedure Precautions. . . . .	7-4		
How Overloading Affects Your Tires . . . . .	7-4		
Tires and Wheels . . . . .	7-5		
Tire Grip . . . . .	7-5		
Hydroplaning. . . . .	7-5		
Flooded Roads . . . . .	7-5		

# Ram ProMaster Van

---

The Airstream Rangeline Touring Coach is integrated into a Ram ProMaster Van. Operation of the ProMaster, its engine, power train, and other related components are discussed in the Ram ProMaster Owner's Manual and other literature provided by ProMaster. As a point of reference, those systems discussed in this literature are warranted by Ram or their suppliers.

## Important ProMaster Information

Your Ram ProMaster Van Owner's and Warranty Manuals contain important Cautions, Warnings, operational, and warranty information on the ProMaster and its components. All information in the ProMaster manual should be reviewed and followed for your safety. The Airstream Owner's Manual may provide additional information and tips on the use of the ProMaster Van as a touring coach; however, no information in the Airstream manual should be interpreted as advice or directions to disregard or void the warnings, cautions, or other information contained in the ProMaster manuals. If you believe there is a conflict in information, Warnings, Cautions, or safety-related information between the ProMaster and Airstream manuals, please contact the Airstream customer relations department immediately to resolve the conflict.

## Fuel

The Ram ProMaster Owner's Manual contains important fuel requirement information on using unleaded gasoline ONLY. Ram states to use high quality unleaded regular gasoline having a posted octane number of 87.

## Component Identification

If repairs are needed, it may be difficult to determine which parts are Ram and which are Airstream's responsibility. The following partial lists show the major components of the van and the company responsible for their servicing.

For assistance in locating a Ram service center in the United States visit <https://www.ramtrucks.com> and use their dealer locator or call 866-726-4636.

See Ram ProMaster Warranty Information for complete instructions on obtaining warranty service.

## ProMaster Van - Serviced by Ram ProMaster or ProMaster Suppliers

### Chassis

Engine	Speed control
Exterior automotive lights	Advanced safety system
Engine battery	Security systems
Power mirrors	Automotive electrical systems
Engine cooling system	Instrument panel cluster
Fog lamps	Hitch receiver and tow plug
Transmission	Doors, cab, side and rear cargo
Chassis suspension	Drivers/passenger seats (except for seat covers)
Brakes	Windows and windshield
Drive axle and hubs	AM/FM radio antenna
Steering assembly, Steering wheel	Dash Multimedia Center
Automotive fuse panel	AC/heater/defroster
Wheels, Tires	Cargo door assist handle
Parking Brake	Camera system
Alternator	
Fuel pump	

## Airstream Components - Serviced by Airstream Authorized Service Centers or Airstream suppliers.

### Cab Area

Driver's and passenger's seat covers

Fire Extinguisher

### Living Quarters

Interior furniture	Floor covering
Appliances in the lounge/lavy/galley area.	All plumbing systems
Smoke/CO detector	SuperSprings® Suspension Components
Window Coverings	

## Electrical Components

Power Center	12-volt living area system
Inverter/Charger	Multiplex System
House battery	Appliances
Battery disconnect	Lighting
Vents	
120-volt system	

## Exterior

Exterior lights	Generator
Awning	Solar panels
Water Service Compartment	Exterior Outlet
Black tank dump valve	Smart Plug Inlet
Windows with screens	

### NOTE

Some features listed may not be available on your touring coach.

### NOTICE

Please contact Airstream or Onan for a service location if repairs are need for the generator.

If you need further clarification or information, contact the Airstream Customer Relations Department at (937) 596-6111 or email [support@airstream.com](mailto:support@airstream.com) before contacting a service center for an appointment.

If you wish to write, the address is:

Airstream Inc.  
 Attn: Customer Service  
 428 W. Pike Street  
 P.O. Box 629  
 Jackson Center, Ohio 45334

## Tires

Underinflated and overinflated tires are dangerous. Underinflation can result in tire flexing, heat build-up, tire overloading, bad handling, poor fuel economy, and uneven wear. Overinflation can result in abnormal wear, bad handling, and a harsh ride.

Check tire inflation pressures following the Ram ProMaster Owner's manual guidance. Always check tire pressure when significantly changing the load you plan to carry in your touring coach. Always check tire inflation pressures when the tires are "cold." For tire size, inflation pressure, and load ratings, see [Specifications on page 4-3](#) and see your Ram Promaster Owner's Manual.

Proper front-end alignment improves tire tread mileage. Your front-end suspension parts should be inspected periodically and aligned when needed. Improper alignment may or may not cause the vehicle to vibrate. However, improper toe alignment will cause front tires to roll at an angle, resulting in faster tire wear. Incorrect caster or camber alignment will cause your front tires to wear unevenly and cause the vehicle to pull to the left or right.

Proper wheel balance is essential to ride comfort and can affect handling. Vibration from an out of balance wheel can cause added stress on suspension components, wheel bearings, and can cause loosening of joints, nuts, bolts, wiring and screws if left unaddressed.

## Vehicle Placard and Tire Inflation Pressure Label

The TIRE AND LOADING INFORMATION placard lists the number of people that can be carried in the vehicle, the total weight your vehicle can carry, the tire size designed for your vehicle, and cold inflation pressures for the front and rear.

Check the ProMaster manual for all weights and tire information placard locations. Please take the time to read, understand, and follow all tire safety information provided.

## Proper Tire Inflation

The level of air in your tires affects your vehicle's overall performance. Even the highest quality tire will perform poorly if improperly inflated. Each vehicle has a recommended cold inflation pressure. Check the ProMaster manual for all weights and tire information and the placard location; also see [Specifications on page 4-3](#).

Since the touring coach's loading configurations will vary, the load on each tire will vary. For this reason, check air pressure based for each tire's load.

### Cold Inflation Pressure

Cold tire inflation pressure is defined as the tire pressure after the vehicle has not been driven for at least three hours or driven less than 1 mile (1.6 km) after sitting for a minimum of three hours. Inflation pressure is measured in units of PSI (pounds per square inch) or kPa (kilopascals). Check your tire air pressure at least once a month, before each trip, and each morning you drive during a trip. Make sure the valves and caps are free of dirt and moisture.

### Underinflation

Underinflation increases susceptibility to damage due to road hazards, reduces tire casing durability, and causes a loss in fuel economy, plus uneven or irregular tire wear. Severe underinflation increases the risk of tread separation, handling difficulties, and possibly tire failure caused by overheating.

## **⚠ WARNING**

**It is a common practice for motorhome owners to lower tire pressure in their search for a smoother ride. This is not only dangerous, it is relatively ineffective, and the difference in ride quality is not significant. When minimum inflation pressure requirements are not met, tire durability and optimum operating conditions are compromised. Tire inflation pressure should always meet at least the minimum guidelines for vehicle weight.**

## Tire Inflation Procedure Precautions

- BE SAFE - Tires run with more than a 20% underinflation (approximate) must be dismantled and inspected by a trained professional. Due to the risk of explosion, it should not be inflated without a full inspection or a safety cage. Failure to do so could potentially result in a fatal injury.
- Use a calibrated gauge. A special gauge designed for larger tires will be required if your tire is rated for higher inflation pressures.
- It may be necessary to inflate your tires at a truck stop or truck service center to achieve adequate air pressure for your coach's needs.
- Only permanent air seal metal valve caps should be used.

## **⚠ WARNING**

**Due to RISK OF EXPLOSION damaged tires or tires run with more than a 20% underinflation (approximate) must be dismantled, inspected by a trained professional, and should not be inflated without using a safety cage.**

- Do not bleed air from warm tires to reduce pressure buildup.
- Do not inflate tires to cold psi rating beyond rim specifications.

## How Overloading Affects Your Tires

Tire pressure is what enables your touring coach tire to support loads. Overloading your tires can have serious consequences for passengers and your touring coach. Too much weight can cause stress on your touring coach's suspension system, brake failure, shock absorber damage, handling and steering problems, irregular tire wear, and possible tire failure. Excessive loads or underinflation can lead to excessive heat and tire failure. If you discover that your tires cannot handle the load, lighten the weight of the load on your tires.



## Tires and Wheels

(This section is partially excerpted from the Ram ProMaster Van Owner's Manual.)

Examine tires for excessive tread wear and uneven wear patterns. Check for stones, nails, glass, or other objects lodged in the tread or sidewall. Inspect the tread for cuts and cracks. Inspect sidewalls for cuts, cracks, and bulges. Check the wheel fastener torque for tightness. Check the tires for proper cold inflation pressure. Use only wheels and tires of the same size, make, load rating, and pattern.

Do not install tires that are not approved for the size and type of wheel installed on the vehicle itself. Only use those wheel sizes that were delivered to you by your authorized Ram ProMaster dealer. Use only wheels and tires that have been tested and approved by the vehicle manufacturer.

Break in the tires at moderate speeds for a distance of about 65 miles.

### **WARNING**

**Always replace lug nuts that are damaged or rusted. Never apply oil or grease to lug nuts. Damaged wheel hub threads should be repaired immediately. Incorrect mounting bolts or improperly tightened mounting bolts can cause the wheel to come off. This could cause an accident. Make sure to use the correct mounting bolts. Check tightness of lug nuts regularly and retighten if necessary.**

## Tire Grip

Tire grip decreases rapidly on wet or icy roads, especially when the tread depth is below 1/8 inch. Adjust speed and driving style to suit road conditions.

## Hydroplaning

Hydroplaning may occur, even at low speeds and with new tires, depending on the depth of the water layer on the road. Reduce vehicle speed, avoid grooves in the road, and apply brakes cautiously in the rain.

## Flooded Roads

Most flood-related deaths happen when attempting to drive through moving water. Most cars will float (and be swept away) in 18-24 inches of moving water. Trucks and SUVs have only 6-12 more inches of clearance. Creeks and rivers can rise rapidly, and the road bottom can also wash away. When these conditions occur, water may be much deeper than it appears. Vehicles often roll to one side or flip over entirely when swept downstream, limiting the time necessary to escape.

## Changing a Tire

(Partially excerpted from the Ram ProMaster Van Owner's Manual)

Any time a wheel has been removed and reinstalled on the vehicle, the wheel fasteners should be torqued using a properly calibrated torque wrench with a six-sided (hex) deep wall socket.

Tighten the lug nuts/bolts in a star pattern until each nut/bolt has been tightened twice. Ensure that the socket is fully engaged on the lug nut/bolt (do not insert it halfway). After 25 miles (40 km), check the wheel fastener torque to be sure that all the lug wheel bolts or lug nuts are properly seated against the wheel. For torque value, [see Specifications on page 4-3](#)

If new or repainted wheels are fitted, the lug nuts must be retighten again after about 600 to 3000 miles. Do not use remolded tires or retreads.

### **⚠ WARNING**

**To avoid the risk of forcing the vehicle off the jack, do not tighten the lug nuts/bolts fully until the vehicle has been lowered. Failure to follow this warning may result in personal injury.**

### **⚠ WARNING**

**Fitting wheel sizes other than those supplied by Ram to the vehicle will change the ProMaster's handling characteristics and may lead to an accident resulting in severe personal injuries, death and property damage.**

### **⚠ WARNING**

**The Ram ProMaster Owner's Manual contains important cautions, warnings, specifications, and operational information on changing, maintaining, and replacing of the tires and wheels. Read, understand, and follow the ProMaster manual sections for changing a tire.**

### **⚠ CAUTION**

**Changing a tire on a touring coach chassis is a physically demanding procedure. It requires specialized tools and knowledge of safety procedures. Only you can determine your knowledge base and physical ability. Don't take any unnecessary risks. Find a safe area to park your unit, and call a tire service center and supply them with the information in the ProMaster Manual if you have any doubts about changing a tire.**

## Flat Tire

Airstream does not provide a spare tire with the Rangeline, however, you can purchase one aftermarket. Refer to your Ram Promaster Owner's Manual before attempting to change a tire.

If you get a flat tire while driving, gradually decrease your speed. Hold the steering wheel firmly and slowly move to a safe place on the side of the road.

### **⚠ WARNING**

**To help avoid personal injury, use a jack only to lift the vehicle during a wheel change. Never get beneath the vehicle while it is supported by a jack.**

## Precautions When Changing a Wheel

- Keep hands and feet away from the area under the lifted vehicle.
- Always set the parking brake and do not disengage when the vehicle is raised.
- Always block wheels before raising vehicle with jack.
- Always use the jack on a level surface.
- Do not jack the vehicle up more than 1-2 in. between the tire and the surface. Otherwise, the vehicle may tip over and may cause serious injury or death to you or others.
- Be sure that the jack arm is fully seated in the jack take-up bracket.
- Always lower the vehicle onto sufficient capacity jack stands before working under the vehicle.
- Do not damage, grease, or oil lug nuts or stud threads.

### Procedure

- Park the vehicle on a firm, level, non-slippery surface.
- Switch on the hazard warning flasher switch, set the parking brake, and place the transmission selector in "P".
- Everyone must leave the vehicle before you jack it up.
- Everyone must leave the danger zone before you jack up the vehicle. Danger zones vary with locations. Take a minute and look at what might happen if the vehicle falls off the jack and rolls. Set up your danger zone.
- The vehicle must be safeguarded in accordance with legal regulations (such as using a warning triangle).
- Prevent vehicle from rolling away by blocking wheels with wheel chocks (not supplied with vehicle) or sizable woodblocks or stone. On a level road place one chock in front of and one behind the wheel that is diagonally opposite to the wheel being changed. When changing a wheel on mild uphill or downhill grade, place chocks on the downhill side blocking both wheels of the other axle. Do not jack vehicle up on a steep grade.

### **⚠ WARNING**

**Do not change wheels on a steep uphill or downhill grade. The vehicle may begin to move and fall from the jack, which could cause property damage, personal injury, and/or death.**

### Jack

Read, understand, and follow the Ram ProMaster Owner's manual instructions, cautions, and warnings for changing a wheel and jack point locations.

- Loosen the lug nuts before raising the vehicle.
- Close the release valve on the jack.
- Assemble the pump lever provided and insert it into the socket on the jack.
- Secure lever by turning it clockwise in the socket.
- Position the jack under the appropriate jack point and raise the vehicle by pumping the lever.

### **⚠ WARNING**

**A jack is intended only for raising the vehicle briefly, for changing a wheel. The jack must be placed on a firm, flat surface only. Do not crawl under the vehicle while it is raised with a jack. Do not start the engine while the vehicle is jacked up. Do not jack the vehicle up more than 1-2 in. between the tire and the surface. The vehicle may tip over and cause serious injury or death to you or others. Jack stands must always be used while working beneath the vehicle. Failure to follow these precautions could result in property damage, personal injury, and/or death.**

## Installing and Removing A Wheel

- Loosen the wheel fasteners (wheel bolts or lug nuts).
- Jack up the vehicle until the wheel is clear of the ground.
- Unscrew the fasteners and remove the wheel (keep the fasteners clean).

### **⚠ WARNING**

If the vehicle moves forward or backward while it is being jacked up, lower it, stabilize the vehicle, and repositioned the jack. When the vehicle is jacked up, the jack must stand vertically (plumb-line).

### Mounting a New Wheel

- Before fitting the spare wheel, clean rust and dirt off the contact surfaces of the wheel and the wheel hub and from wheel bolts or lug nuts.
- Note the specified wheel and tire size, tire load capacity, and speed code.
- Do not change the tire's direction of rotation.
- Do not damage, grease, or oil wheel bolts or lug nuts or their threads.

### Centering Wheels With Wheel Fasteners

- Install the wheel and snug the wheel fasteners.
- Slightly tighten wheel fasteners.

### Lowering the Vehicle

- Slowly open the jack release valve to lower the vehicle until tire is resting on the ground.
- Tighten the wheel fasteners in a crisscross pattern, as specified, with a torque wrench. For wheel fastener torque procedures, see the Ram ProMaster Van Owner's Manual.
- Remove the jack and stow.
- Check the tire pressure. For tire pressures see the Ram ProMaster Owner's Manual or [see Specifications on page 4-3](#).
- Retighten the wheel fasteners to the specified torque with a torque wrench after a distance of approximately 25 miles.

### **⚠ WARNING**

Only certain tires meeting the tire size/load/speed index ratings contained in the Tire Pressure Tables, found in the Index Section of the Ram ProMaster's Owners, are certified to conform to FMVSS 120 for the ProMaster Vehicle at this time. Please check the sidewalls of your originally-equipped tires for specific makes/sizes, and speed load ratings when you need to replace your tires. To prevent accident, injury, or possible death, use only the correct tires for your tire replacement.

### Wheel Bolt/Lug Nut Tightening

Torque wheel fasteners evenly to specification with a torque wrench using a crisscross pattern in the proper sequence:

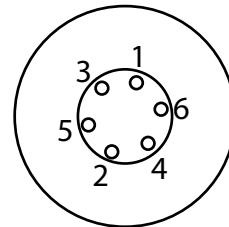

### **⚠ WARNING**

Consult the Ram ProMaster Owner's manual for extensive wheel installation, tightening, torque procedures, cautions, and warnings.

### **⚠ WARNING**

Wheel fastener torque must be checked immediately after reinstalling a wheel and again after 25 miles. Torque all wheel fasteners evenly to specification using the proper sequence. For torque values, [see Specifications on page 4-3](#).

### **⚠ WARNING**

Tightening by hand or with an impact wrench can result in loose or overtightened wheel fasteners, which could lead to a wheel falling off while driving or damage wheel and brake components.

**Tire Rotation**

Front and rear tires perform different jobs and can wear differently depending on the types of roads driven, driving habits, etc. To obtain the longest tire life, you should inspect and rotate your tires regularly.

Many automotive dealers and tire dealers will perform a free tire inspection to look for uneven or abnormal tire wear.

Tires should be rotated every 6,000 to 8,000 miles. For the longest tire life, any time irregular wear is seen have the tires checked, alignment checked, and tires rotated by your truck or tire dealer. Have the cause of uneven wear corrected.

**Rotation Pattern For Wheels**

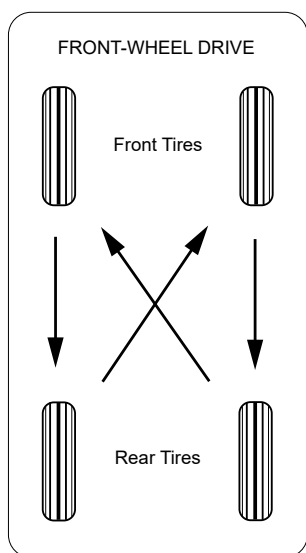

**⚠ WARNING**  
 Read the Ram ProMaster Owner's Manual for complete instruction on tire rotation, installation, and maintenance.

**Support**

Since touring coach's may sit for long periods it is important to properly support the tires if blocks are used for leveling.

Caution must be taken to ensure that the tires are fully supported when using blocks to level the touring coach. The load on the tire should be evenly distributed on the block. If not done, the steel cables in the sidewall of the tires may be damaged and could lead to premature fatigue of the sidewall.

**Correct**

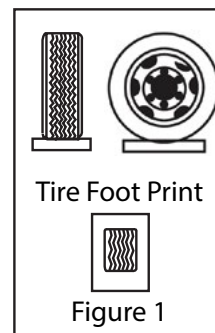

The CORRECT method is shown in Figure 1. The tire is supporting the full load. Please note that the block is wider than the tread and longer than the tire's footprint. This provides maximum support to the tire and ensures that the load is evenly distributed throughout the tire's footprint area.

**Incorrect**

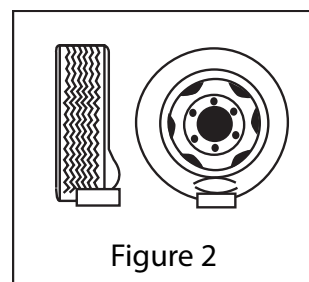

INCORRECT method is shown in Figure 2: A portion of the tire is supporting the full load.

**⚠ WARNING**  
 Tires that are incorrectly supported may be damaged, which could lead to casing failure resulting in serious injury or property damage. If, on previous occasions, the tires have been incorrectly supported, hidden damage may be present. Please contact your local tire dealer and request an inspection and a determination of possible damage.



# AIRSTREAM®

## Section 8 DRIVING

LOADING . . . . .	8-2	TRAILER TOWING AND DRIVING TIPS . . . . .	8-5
Weighing . . . . .	8-2	Trailer Hitches . . . . .	8-5
Vehicle and Trailer Weights and Ratings Definitions . . . . .	8-2	Loading a Trailer . . . . .	8-6
Procedure for Weighing a Touring Coach . . . . .	8-3	Checking Weights of Vehicle and Trailer . . . . .	8-6
Weight and Loading Considerations . . . . .	8-3	Attaching a Trailer . . . . .	8-6
SAFETY . . . . .	8-4	Towing a Trailer . . . . .	8-7
Seat belts . . . . .	8-4	Towing a Boat . . . . .	8-7
Child Safety Seat . . . . .	8-4	Tracking . . . . .	8-8
LATCH (Lower Anchors and Tethers for Children) . . . . .	8-4	Brake Controller . . . . .	8-8
How to Install a LATCH Equipped Seat . . . . .	8-5	Backing Up . . . . .	8-9
		Passing . . . . .	8-9
		Parking Your Touring Coach . . . . .	8-9
		Additional Towing Information . . . . .	8-10
		TOWING YOUR TOURING COACH . . . . .	8-10
		SAFETY CHECK LIST . . . . .	8-10
		Exterior Check List (Before Entering Vehicle) . . . . .	8-10
		Interior Check List (Before Driving) . . . . .	8-10

## Loading

One of the most critical aspects of safely operating a touring coach is understanding how to load them properly. Key considerations are the weight of the cargo, whether or not it is within limits, the location of the load, and how it affects vehicle handling.

The Cargo Carrying capacity tag (example below) is on every touring coach inside the door. Do not try to guess what your touring coach weighs loaded. Load your touring coach cargo, including water, fuel, etc., and take it to a public scale. Weigh each axle of your vehicle. Refer to your axle weight and tire limits to see if you are within a safe range; [see Specifications on page 4-3](#). Add the weight of passengers and total all axle weights and make sure you are below the GVWR.

Ensure the load is balanced. Do not load too much on any one side of the vehicle. Check side-to-side and front-to-back by stepping back and looking at your touring coach. Ensure there is not too much weight on any one side. A balanced load is much easier to tow or drive.

Be sure to secure all items. Loose items can cause damage and can be a safety issue.

MOTOR HOME OCCUPANT AND CARGO CARRYING CAPACITY VIN ##### THE COMBINED WEIGHT OF OCCUPANTS AND CARGO SHOULD NEVER EXCEED XXX kg or XXX lbs Safety belt seating capacity:XXX CAUTION A full load of water equals XXX kg or XXX lbs of cargo @ 1 kg/L (8.3 lb/gal) and the tongue weight of a towed trailer counts as cargo
--

To arrive at the COMBINED WEIGHT OF OCCUPANTS AND CARGO SHOULD NEVER EXCEED number, Airstream weighs the vehicle as finished and adds the weight of the chassis fuel. That number is subtracted from the GVWR of the touring coach and listed on the tag. The total weight of all cargo, including but not limited to dealer or customer modifications or additions, fluids (fresh water and holding tanks), food, clothes, tools, tongue weight of a towed trailer or vehicle, and passengers should never exceed the number listed while the touring coach is in transit.

The SAFETY BELT SEATING CAPACITY is the number of seat belts provided for occupants allowed onboard during travel.

The FULL LOAD OF WATER EQUALS number is arrived at by multiplying the fresh water tank by 1Kg/L or 8.34 lb/gal.

When loading the vehicle, keep the GVWR, GAWR, Tire Weight Ratings (listed on the vehicle tire Information placard), and the cargo and occupant capacity in mind, and do not exceed these specifications. Your safety depends on not overloading the touring coach, axles, and tires; [see Specifications on page 4-3](#).

## Weighing

To determine the actual weight of your vehicle with cargo, water, and fuel it must be weighed on scales as you plan to travel. The most common scales are those used by states to weigh trucks along the highway. Grain elevators, cement outlets, and gravel pits in rural areas are good sources.

<b>NOTE</b> <b>The following page explains weighing instructions for this touring coach. If you have trouble locating scales, your State's Highway Patrol may be able to assist. Some state DOT websites also provide this information.</b>
--

### ***Vehicle and Trailer Weights and Ratings Definitions***

Gross Vehicle Weight Rating (GVWR) is the maximum permissible weight of the touring coach.

Gross Vehicle Weight (GVW) comprises weight of vehicle including tools, installed accessories, passengers, cargo, and trailer tongue weight. It must never exceed the GVWR.

Gross Axle Weight Rating (GAWR) is the maximum permissible axle weight.

Gross Trailer Weight (GTW) is the maximum permissible trailer weight to be towed.

Trailer Tongue Weight Rating (TWR) is the maximum permissible weight of the trailer tongue. This counts as cargo when loading a touring coach.

<b>NOTE</b> <b>Check the ProMaster manual for all weights and tire information placard location.</b>
---



Front Axle GAWR	GVWR	Rear Axle GAWR	GCWR - GVW
SCALE WEIGHT		Optional Tow Weight	
STEP 1 Front Axle GAW	STEP 2 GVW	STEP 3 Rear Axle GAW	STEP 3a Tow Weight minus Weight of Trailer or Vehicle Towed
INDIVIDUAL WHEEL POSITION WEIGHT			
STEP 4 Left Front Wheel Position	STEP 5 Left Side (Total LF + LR)	STEP 6 Left Rear Wheel Position	
Calculated	Calculated	Calculated	
Right Front Wheel Position Step 1 minus Step 4	Right Front (Total RF + RR) Step 2 minus Step 5	Right Rear Wheel Position Step 3 minus Step 6	

GAWR = Gross Axle Weight Rating  
 GVWR = Gross Vehicle Weight Rating  
 GCWR = Gross Combination Weight Rating

### Procedure for Weighing a Touring Coach

Vehicle should be weighed loaded, as you normally travel.

1. Fill in first row from Specification Section of this manual; [see Specifications on page 4-3](#).
2. Weigh vehicle as shown in row 2 (Scale Weight) and fill in blanks.
3. Weigh one side of vehicle as shown in Individual Wheel Position Weight.
4. Calculate other side as shown in last row.

### Weight and Loading Considerations

Touring coach's have fluid holding tanks and ample storage. It gives you great flexibility in loading. If you want to load down all the storage compartments, the amount of fluids may have to be reduced. Distribute your additional cargo as evenly as possible with the heaviest objects located as low as possible.

Even if you're going to a remote area, you can usually fill your water tank shortly before entering the area. Just reducing your load by 10 gallons of water lets you carry an additional 83.4 lbs. of cargo.

## Safety

### Seat belts

The driver, passenger, and second-row seats have federally approved seatbelts. Most states require, by law, that all passengers in a motor vehicle use seatbelts while in transit. All occupants should remain seated with their safety belts firmly attached while the touring coach is in transit.

The driver should adjust their seat so they can reach all controls easily with the belt on and use the full travel of the foot brake. Place seatbelts low around the hips to prevent sliding out from under them in case of an accident. Doing so places the body's load on the strong hipbone structure instead of around the soft abdominal area. Remember, there should only be one occupant per seatbelt when traveling.

For seatbelt buckle operation, see the Ram ProMaster manual.

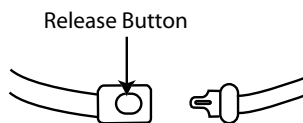

### **⚠ WARNING**

**Become familiar with and follow all directions, advice, and warnings pertaining to seats, seatbelt operation, and restraint systems provided in the Ram ProMaster Owner's Manual. Do not allow passengers to ride anywhere in the touring coach except in seats with approved seatbelts.**

### Child Safety Seat

(Some text is partially excerpted from Ram ProMaster Owners Manual.)

#### **⚠ DANGER**

**Never place a rear-facing child restraint in front of an air bag. A deploying passenger front air bag can cause death or serious injury to a child 12 years or younger, including a child in a rear-facing child restraint.**

#### **⚠ DANGER**

**Never install a rear-facing child restraint in the front seat of a vehicle. Only use a rear-facing child restraint in the rear seat. If the vehicle does not have a rear seat, do not transport a rear-facing child restraint in that vehicle.**

Safety experts recommend that children ride rear-facing in the vehicle until they are two years old or until they reach either the height or weight limit of their rear-facing child restraint. Two types of child restraints can be used rear-facing: infant carriers and convertible child seats.

The infant carrier is only used rear-facing in the vehicle. It is recommended for children from birth until they reach the weight or height limit of the infant carrier. Convertible child seats can be used either rear-facing or forward-facing in the vehicle. Convertible child seats often have a higher weight limit in the rear-facing direction than infant carriers do, so they can be used rear-facing by children who have outgrown their infant carrier but are still less than at least two years old. Children should remain rear-facing until they reach the highest weight or height allowed by their convertible child seat.

#### ***LATCH (Lower Anchors and Tethers for Children)***

LATCH is a system that makes child safety seat installation easier (without using seatbelts). The LATCH system is a standard feature on the second row bench seat.

The LATCH equipped touring coach has two sets of small bars, called anchors, located in the crease of the seat where the back and bottom cushions meet. LATCH compatible child safety seats have a lower set of attachments that fasten to these vehicle anchors.

### How to Install a LATCH Equipped Seat

ALWAYS read and follow the vehicle owner's manual and child safety seat manufacturer's instructions for correct installation and proper use.

1. Fasten the child safety seat's top tether to the vehicle's anchor on the back of the seat (located near the bottom of the seat).
2. Fasten the child safety seat's lower attachments to the vehicle's lower anchors (located in the crease of the seat). Tighten and adjust according to the instructions and check for a secure fit. The child safety seat should not move more than an inch forward or sideways.



### NOTE

If you are unsure if your child safety seat is compatible, look for the following LATCH logo.



### Trailer Towing and Driving Tips

(Some text is partially excerpted from Ram ProMaster Owners Manual.)

#### **⚠ WARNING**

Failure to use proper equipment and driving technique can result in losing vehicle control when towing a trailer. Improper towing or failure to follow the instructions contained in this section can result in serious injury. Follow the guidelines below carefully to ensure safe trailer operation. Ask your authorized Ram ProMaster or Airstream dealer if you require an explanation of the information contained in the manuals.

#### Trailer Hitches

Units have hitches and wiring installed by Ram. The ProMaster has a 7-way connector for lights and a charge line. Review all sections of the Ram ProMaster Manual prior to towing. Remove the hitch ball adapter from the receiver when not in use to reduce the possibility of damage.

Since this vehicle is designed and intended primarily as a load-carrying vehicle, towing a trailer will affect handling, durability, and economy. Maximum safety and satisfaction depend upon properly using the correct equipment and avoiding overloads and other abusive operations.

#### **⚠ WARNING**

The total weight of the touring coach and trailer must not exceed the GCWR listed in the specification section of this manual. The maximum towing capacity varies according to the size of the touring coach and its GCWR. Vehicles should be properly equipped for towing trailers. Information on trailer hauling capabilities and special equipment required may be obtained from your Ram ProMaster and/or Airstream dealer.

## Loading a Trailer

You should not exceed the permissible GTW (Gross Tongue Weight) or the trailer GVWR when loading a trailer.

Maximum permissible values are listed on the safety compliance certification labels for the vehicle and trailer. For their location, see the Ram ProMaster Owner's Manual. The lowest value listed must be selected when determining how the vehicle and trailer are loaded.

The tongue weight must be approximately 10-15 percent of the loaded trailer weight to ensure proper handling but not to exceed the hitch rating.

Tongue loads can be adjusted by proper distribution of the load in the trailer and checked by weighing the loaded trailer separately and then the tongue. The tongue weight at the hitch must be added to the GVW to prevent exceeding your ProMaster towed vehicle's rear GAWR.

Touring coach tires should be inflated to the highest pressures shown on the ProMaster Tire Information Placard when towing trailers. See Ram ProMaster Owner's Manual for its location. This vehicle's Cargo Carrying Capacity (CCC) is reduced by the amount that equals the trailer tongue load on the trailer hitch.

## Checking Weights of Vehicle and Trailer

To ensure the tow vehicle and trailer are within weight limits, weigh the vehicle-trailer combination on a commercial scale (tow vehicle including driver, passengers, cargo, and trailer fully loaded); see [Weighing on page 8-2](#).

Also, check the vehicle's front and rear axle weights and tongue weight. The values as measured must not exceed the ProMaster weight ratings listed on vehicle information placards and in the Ram ProMaster manual; see [Specifications on page 4-3](#).

### NOTE

**Check the Ram ProMaster manual for all weights and tire information placard locations.**

## Attaching a Trailer

Please observe maximum permitted trailer dimensions (weight and length).

Most states and all Canadian provinces require safety chains between your tow vehicle and trailer. The chains should be crisscrossed under the trailer tongue. They must be attached to the hitch receiver and not to the vehicles bumper or axle. Be sure to leave enough slack in the chains to permit turning corners.

Most states and all Canadian provinces require a separate brake system for towing trailers.

### ⚠ WARNING

**The towing vehicle's braking system is rated for operation at GVWR, NOT at the GCWR. A separate, functioning brake system is required for any towed vehicles or trailers weighing more than 1000 lb (450 kg) when fully loaded. NEVER exceed the GVWR, or the GAWR specified on a touring coach certification label. Also, NEVER exceed the weight ratings of a trailer hitch installed on a touring coach. Failure to heed any part of this warning could result in loss of control of the touring coach and towed vehicle or trailer which may cause an accident and serious injury. For specified towed vehicle braking requirements, consult the Ram ProMaster Owner's Manual that comes with this vehicle.**

### ⚠ WARNING

**Do not connect a trailer brake system (if trailer is so equipped) directly to the vehicle's hydraulic brake system if your vehicle is equipped with anti-lock brakes. If you do, neither the vehicle's brakes nor the trailer's brakes will function properly. Property damage, injury, or death to you or others may be the result.**

The provided vehicle electrical wiring harness for trailer towing has a brake signal wire for hookup to a brake controller. Most states and all Canadian provinces require a breakaway switch on trailers with a separate brake system. The switch activates the trailer brakes in the possible event that the trailer might separate from the tow vehicle. Please consider using a trailer sway control system. For further information, see your authorized Ram ProMaster or Airstream dealer.

## Towing a Trailer

There are many different laws, including speed limit restrictions, having to do with trailer towing. Make sure that your vehicle-trailer combination will be legal for where you reside and where you'll be driving. A good source for this information can be the State Attorney General, State Police, or local authorities.

Before driving with a trailer, check the hitch, breakaway switch, safety chains, electrical connections, lighting, and tires. Also, adjust the mirrors to permit an unobstructed view beyond the rear of the trailer.

If the trailer has brakes using an electric brake controller, start your vehicle and trailer moving slowly, and then apply the brakes manually using the brake controller to be sure the brakes are working properly. Read and follow the controller manufacturer's recommendations.

Always secure items in the trailer to prevent load shifts while driving. While towing a trailer, occasionally check to be sure the load is secure.

The vehicle and trailer combination is heavier, therefore limited in acceleration ability, and requires longer stopping distances. It is more prone to reacting to side wind gusts and requires more sensitive steering input. Handling characteristics are different and less stable than when operating the vehicle without a trailer. It is important to avoid sudden maneuvers.

If possible, do not brake abruptly, but rather engage the brake slightly at first to permit the trailer to activate its brake. Then increase the braking force.

When driving in mud and sand, let the momentum carry the rig through. Apply power gently and use as little as possible. Stay in the tracks of the vehicle ahead and keep the tow vehicle in the highest possible gear. If you are stuck, it is best to tow out the entire rig together without unhitching.

Despite even the best hitch, you will notice that whenever a large bus or truck overtakes your rig the displaced air first pushes the trailer rear slightly to the right and then affects the front. It may be necessary to steer very slightly, momentarily, toward the bus or truck to help compensate for the sway induced by the passing-vehicle. Do not apply the vehicle brakes, as this can tend to exaggerate the situation. You may find, however, that briefly applying the trailer brakes with your manual control will help eliminate sway.

To gain skill and an understanding of the vehicle's behavior, you should practice turning, stopping, and

backing up in an area free from traffic. We want every owner to be a safe and courteous driver. A few hours of towing practice in a large empty parking lot will make pulling your trailer over the road much easier. Line out two corners for left and right turns. You may also use these corners to practice backing and parking.

### **⚠ WARNING**

**On slippery pavement, do not use engine drag to help slow down as this may cause the rear wheels of the tow vehicle to skid. On icy pavement, drive slowly and if you feel the tow vehicle skidding, gently apply the trailer brakes only. This will bring the tow vehicle and trailer back into a single line. Chains do not help trailer wheels.**

## Towing a Boat

While it is possible to tow a boat with your touring coach, Airstream does not recommend it. If you plan to pull and launch a boat, use caution when backing down boat ramps, and do not submerge any part of your touring coach in water. The slope of some boat ramps may be lower than others, requiring a portion of the tow vehicle to be submerged when launching. While this may be okay for some vehicles, your touring coach has sensitive electronics that water infiltration would irreparably damage.

### **NOTICE**

**It is imperative that you do not allow any part of your touring coach to be submerged in water as it could cause damage to electronics that a warranty would not cover.**

## Tracking

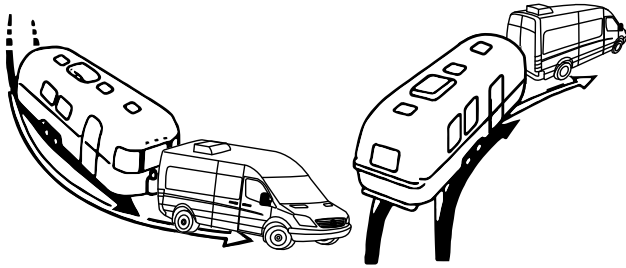

During practice, observe that the tracks made by the trailer wheels are distinctly different from those made by the tow vehicle. Studying this will make it easier for you to correct mistakes. Consider truck or trailer-type fender or door grip rear view mirrors for maximum visibility. In most states, the law requires them.

After thoroughly inspecting your hitch, brakes, and tires, you should be ready to tow. Check traffic, signal that you are about to pull away, and start slowly. Look often in your mirrors, observe the trailer's action, and then carefully move into the proper traffic lane. Remember that the trailer wheels will not follow the path of the tow vehicle wheels; therefore, wider turns are a necessity.

Try to pick the lane you want on freeways or expressways and stay in it. Always maintain plenty of space between you and the car ahead, at least the length of the tow vehicle plus trailer for every ten mph. To pass another vehicle, you will need longer to accelerate. You must also allow for the trailer length when returning to the right-hand lane. On a two-lane road, cars may be lining up behind you because you are traveling at a lower speed. It is courteous and sensible to signal and pull over at the earliest safe opportunity and let them pass.

### **⚠ WARNING**

**Consider that when towing a trailer, the handling characteristics are different and less stable from those with operating the vehicle without a trailer. It is important to avoid sudden maneuvers. Sudden maneuvers may lead to loss of control over the vehicle-trailer combination.**

## Brake Controller

The brake controller (if so equipped) is activated when you apply the brakes of the tow vehicle. Your tow vehicle brakes will automatically apply the trailer brakes first when properly adjusted. This will help keep your tow vehicle and trailer in a straight line and make you stop as if you were driving the tow vehicle alone. If swaying or swerving should occur, briefly operating the controller separate from the vehicle brakes may help correct the situation. Practice this maneuver on a clear highway. Do not wait for an emergency.

### **⚠ WARNING**

**Per Ram, if you use a trailer brake controller with your trailer, the trailer brakes may be activated and deactivated with the brake switch. If so, there may not be enough brake pressure to hold both the vehicle and the trailer on a hill when the brake pedal is released. In order to avoid rolling down an incline while resuming acceleration, manually activate the trailer brake or apply more vehicle brake pressure prior to releasing the brake pedal.**

## Backing Up

While backing, the important thing to remember is to GO SLOW and if you see the trailer turning the wrong way, correct it immediately. Concentrate on the rear of the trailer. With your tow vehicle and trailer in a straight line, back up slowly and turn the bottom of the steering wheel in the direction you want the trailer to go. Watch the side mirror until the rear of the trailer is pointing in the desired direction. Your tow vehicle will be following the trailer in an arc. Straighten the tow vehicle and trailer by turning the steering wheel more sharply, and then when they are in line, straighten the steering wheel.

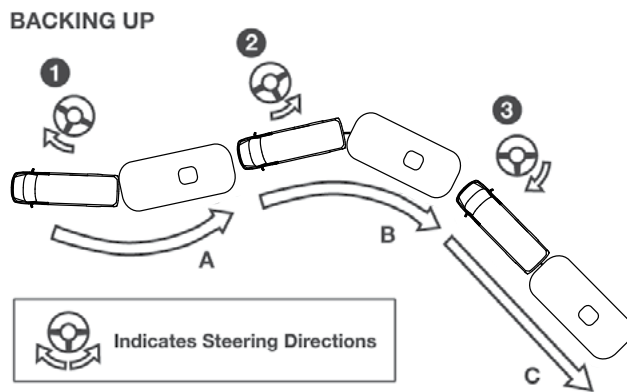

Start in position (A) start. Turning steering wheel as shown in (1). will put you in trailer position (B). Turning steering wheel show in position (2) puts you in trailer position (C). Steering position (3) returns front wheels to straight backing.

### NOTICE

**Always try to back to your left because the visibility is much better.**

When you do not make it on the first try it is usually much easier to pull forward to your original straight position and start over.

If your spouse or traveling companion normally directs you when backing they should position themselves forward of the tow vehicle so the driver can easily see them. Their directions should always indicate to the driver the direction the rear of the trailer should go. A little practice in a parking lot with the person giving directions can save a lot of frustration when backing into a campsite.

## Passing

Extreme care must be exercised when passing another vehicle. A vehicle with a trailer attached will require additional passing distance than when driving without a trailer. Because your vehicle and trailer is longer than your vehicle alone, you will also need to go much further ahead of the passed vehicle before you can return to your lane.

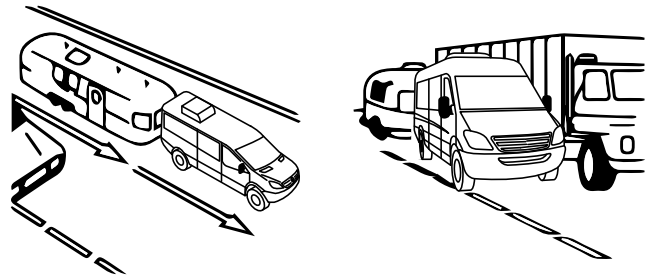

## Parking Your Touring Coach

To reduce the risk of personal injury or damage to the vehicle power train as a result of vehicle/trailer movement when parking, always:

- Keep right foot on the brake pedal.
- Shift gear selector lever to position "N".
- Have a second person place wheel chocks on downhill side of left and right trailer wheels.
- Slowly release the brake pedal allowing the vehicle and trailer to roll into chocks until stopped.
- Press the electronic parking brake button to the left of the steering wheel.
- Move gear selector lever to position "P".
- On inclines, turn wheels toward the road curb.

### ⚠ WARNING

**CHOCK THE TRAILER WHEELS when stopping on a hill or slope. Leaving your tow vehicle in gear is not enough for standstill safety. Do not use trailer brakes as parking brakes.**

## Additional Towing Information

Refer to the Trailer Towing section in your Ram Promaster Owner's manual and carefully review all sections related to towing, and engine and transmission overheating.

### **⚠ WARNING**

**Never open a radiator cap when the tow vehicle is hot. Add coolant when the vehicle is cool.**

## Towing Your Touring Coach

See the Ram ProMaster Owners Manual for towing information.

### **⚠ WARNING**

**Considerable damage may occur if the touring coach is improperly lifted for towing purposes. Only qualified professional towing service companies with proper equipment should be used. Observe all cautions and warnings in the Ram ProMaster Owner's Manual before towing your touring coach.**

## Safety Check List

Your Airstream Touring Coach should be given a thorough safety check before a trip. Regular use of the following list will provide safe operation of your touring coach and will help you spot any malfunctioning equipment and correct the problem as soon as possible. The list is to help you and may not be all-inclusive.

### **⚠ WARNING**

**Failure to heed the following items may cause damage to the vehicle or personal injury.**

### Exterior Check List (Before Entering Vehicle)

1. Check condition of tires and keep tires at recommended inflation pressure per the tire; [see Specifications on page 4-3](#).
  2. Check all exterior components are unhooked and properly stowed.
  3. Check that all external compartments and water/waste connections are properly closed, latched, and/or locked.
  4. Check that items stored on exterior of vehicle are securely tied down.
  5. Verify if any items stored on exterior of vehicle would present a clearance problem.
  6. Follow all automotive manufacturer's recommendations on checking and filling fluid levels.
  7. Check exterior lights and general condition of vehicle.
- ### Interior Check List (Before Driving)
1. It is important that all doors be completely closed and locked during travel.
  2. Turn off water pump and close all faucets.
  3. Check that refrigerator door is closed and latched if equipped.
  4. Check that nothing heavy is stored in overhead or high cabinets, which could fall out and cause injury. Heavy items should be stored in lower cabinets.
  5. Ensure the table is in the locked position on the slide and the extension is stowed and locked into position.
  6. Stow the bed in the folded position and velcro the frame into place.
  7. Stow the cooktop.
  8. Check that counter tops and shelves are clear of even small items that could become projectiles during emergency braking or an accident.
  9. Check that internal stowage is secured.
  10. Check that lights and switches are set in positions safe for travel.
  11. Adjust the driver's seat so that you can easily reach and operate all controls. Make sure both driver and passenger seats are facing forward in the upright position, and the swivel function (if equipped) is locked in the forward facing position. Do not adjust driver or passenger seat swivel or recline mechanisms while vehicle is moving. The seat could move unexpectedly causing loss of control.
  12. Check that all passengers have seatbelts on properly.
  13. The freedom of movement of the brake and accelerator pedals must not be impaired.
  14. Check rear view mirrors adjustment, inside and outside. Adjust window coverings if necessary for maximum visibility.
  15. Secure children in a federally-approved child restraint device.



# AIRSTREAM®

## Section 9 MAINTENANCE

MAINTENANCE SCHEDULE . . . . .	9-2	WINTERIZING AND STORAGE . . . . .	.9-10
SUGGESTED MAINTENANCE AND REPLACEMENT PARTS. . . . .	9-3	Touring Coach Winterization . . . . .	.9-10
Interior Care . . . . .	9-4	Component Locations for Winterization . . . . .	.9-10
Exterior Care . . . . .	9-4	Instructions for Winterization . . . . .	.9-10
TIRE CARE . . . . .	9-5	Optional-Additional Steps for Winterization . . . . .	.9-11
Tire Care Tips . . . . .	9-5	Water Heater Winterizing . . . . .	.9-11
Tire Inspection and Storage . . . . .	9-5	Restoring Service . . . . .	.9-11
PLUMBING . . . . .	9-6	Toilet . . . . .	.9-12
Water System (Self-Contained) . . . . .	9-6	Maintenance . . . . .	.9-12
Water Pump and Strainer . . . . .	9-6	Cleaning . . . . .	.9-12
Cleaning the Strainer . . . . .	9-6	Winterization . . . . .	.9-12
Disconnecting the Strainer/Water Pump Lines. . . . .	9-6	ELECTRICAL DIAGRAMS . . . . .	.9-13
Sanitizing . . . . .	9-7	12-Volt Main Schematic . . . . .	.9-13
Sanitizing the Fresh Water System . . . . .	9-7	30-Amp 120-Volt Schematic . . . . .	.9-20
DRAIN AND WASTE SYSTEM . . . . .	9-8	Audio and Video Schematic . . . . .	.9-21
Black and Gray Water Tank Draining . . . . .	9-8	FRESH WATER LAYOUT . . . . .	.9-22
Black Water Tank Flush . . . . .	9-9	FAQS AND ANSWERS . . . . .	.9-23
Drain Systems Cleaning . . . . .	9-9		

# Maintenance

## Maintenance Schedule

### **⚠ WARNING**

Failure to maintain your touring coach can cause premature and unexpected parts breakage and/or erratic operation that may be hazardous.

### **NOTICE**

See appliance manufacturer's literature for further information.

<b>First 20 Hours</b>	
Generator	Change oil after the first 20 hours of run time
To break in the generator, run at 50% load for two hours, then at 75% load for two hours. Refer to the generator manufacturer's manual for more details.	

<b>Every 1,000 miles or 60 days</b>	
Smoke and CO Alarm	Test and replace battery as required
Tires	Check tire pressure; <a href="#">see Specifications on page 4-3</a>
GFCI Circuit Breaker	Test and record

<b>Once a Month</b>	
Hydronic System	Run the burner for at least 15-20 minutes to help maintain the system

<b>Every 5,000 miles or 90 days</b>	
Wheel Fasteners	Torque to Specifications; <a href="#">see Specifications on page 4-3</a>
7-Way Plug	Spray with contact cleaner

<b>Every 10,000 miles or 6 months</b>	
Tires	Inspect and rotate
Windows, and Door Seals	Clean with mild detergent and apply 303 Aerospace Protectant
Exterior	Wax

<b>Every Year</b>	
Hydronic System	Test alkalinity in the system coolant and inspect the exhaust system for damage
Seams	Check and reseal exterior seams, windows, lights, and vents as needed
Interior Cabinets	Visual inspection of latches and locks, hinges and slides; silicone spray as needed
Pop-Top	Inspect and treat the canvas; <a href="#">see Cleaning and Sealing on page 5-10</a>

<b>Every Year or 150 Hours</b>	
Generator	Change oil Replace air filter element

<b>Every 450 Hours</b>	
Generator	Replace spark plug Replace fuel filter Replace air filter element
Refer to the generator manufacturer's manual for all service/maintenance requirements.	

<b>Once every three years</b>	
Hydronic System	Replace Heat Transfer Fluid/ Century Chemical Boiler Antifreeze

## Suggested Maintenance and Replacement Parts

Part numbers listed are Airstream part numbers and can be ordered by calling a certified Airstream dealer.

**⚠ WARNING**

**Always replace the bulb or light fixture with the correct bulb for that light or matching fixture. Failure to heed this warning could cause fire, property damage, personal injury, or death.**

<b>Exterior 12-Volt Lighting – For additional exterior lights refer to your Chassis Owner’s manual.</b>	
Utility Light, Water Service Compartment	PN – 514133
Dump Valve Light, Light Bar, 16”	PN – 514103
LED Sliding Door Light 59”	PN – 514028
Awning Light, LED Strip	PN – 514205
<b>NOTE: Most Exterior Lighting is LED and a replacement fixture will be required.</b>	

<b>Interior 12-Volt Lighting</b>	
LED Bath Light	512376
LED Ceiling Light, Spot Light w/Frosted Lens	514134
LED Aisle Light	514045
LED Aisle Tape Light, 69”	514128
LED Pivoting Reading/Spot Light	514135
<b>NOTE: Most Interior Lighting is LED and a replacement fixture will be required.</b>	

<b>Replacement Breakers - USA Breakers</b>	
Breaker, Bryant, 20 Amp	PN – 510564-01
Breaker, Bryant, 30 Amp	PN – 510564-02
Breaker, Bryant, 20-20 Amp	PN – 510564-04
Breaker, Bryant, 20 Amp GFCI	PN – 510564-06
Breaker, Bryant, 15 Amp GFCI	PN – 510564-07
Breaker, 12V DC Type II, 15 Amp	PN – 510947-15
Breaker, 12V DC Type II, 30 Amp	PN – 510947-30
Breaker, 12V DC Type II, 40 Amp	PN – 510947-40

Replacement Rivets		
	Interior	
Part Number	325134	330031-01
Rivet Name	OBS11-00414	ADS46ABSR
Head Style	Dome Head/ Blind	Dome Head/Pop
Body Diameter (Inches)	0.125 (1/8)	.187 (3/16)
Hole Size	0.129-0.134	0.192-0.196
Drill Number	30	11
Grip Range In (Inches)	0.126-.187	0.376-0.500
Length Under Head (Max. Inches)	2.2	0.675
Head Diameter (Nominal)	3.2	0.835
Head Height (Max. Inches)	0.040	0.393
Typical Sheer Strength (lb)*	364	1000
Typical Tensile Strength (lb)*	445	1375
*Values shown are a guide only and may vary depending upon the application.		

## Interior Care

Rangeline Interior Touch-up	
Caulk, Seamfil, Grey	PN – 360301-45
Caulk, Seamfil, Urban Oak	PN – 360301-46
Fil-Stik, Urban Oak	PN – 360406-04
Fil-Stik, Grey	PN – 360406-20
Stain Marker, Grey	PN – 365504-02
Stain Marker, Urban Oak	PN – 365504-05
Screw Covers, Adhesive, Grey	PN – 203462-03
Screw Covers, Adhesive, Oak	PN – 203462-04

Replacement Filters	
Air Conditioner Filter	690708-101

## Exterior Care

For Exterior bodywork touch-up paint, window seals, and sealant, consult an authorized Ram Promaster Van dealer. For assistance in locating a Ram service center in the United States visit <https://www.ramtrucks.com> and use their dealer locator or call 866-726-4636.

The following exterior care products are recommended by Airstream and widely used across our product lines. Read and follow label directions.

If you are unsure what products to use, consult your Airstream Dealer or the Airstream Customer Relations Department at (937) 596-6111, or email [support@airstream.com](mailto:support@airstream.com)

Exterior sealant should be checked and resealed once a year.

**Walbernize Super Seal (PN - 28433W)** - Use to clean and polish while depositing a reflective, water-proof, glaze finish. Recommend two applications a year.

**Acryl-R Seam Sealer (PN - 28430W-01 [16 oz can-Gray])** - Use anywhere a fine bead of gray sealant is required.

**AdSeal Premium Quality Sealant Adhesive (PN - 365330-01 [10 oz tube-White])** - Use anywhere a thicker bead of White sealant is required.

**AdSeal Premium Quality Sealant Adhesive (PN - 365330-02 [10 oz tube-Gray])** - Use anywhere a thicker bead of Gray sealant is required.

**AdSeal Premium Quality Sealant Adhesive (PN - 365330-04 [10 oz tube-Black])** - Use anywhere a thicker bead of Black sealant is required.

## Tire Care

The most important function of tires is to provide traction while moving and grip when steering or stopping. The tires on your touring coach are designed for highway use and must be properly maintained to maximize tire life and provide a safe mode of transportation.

For tire size and inflation pressure, see [Specifications on page 4-3](#). For additional information on tire care, inflation procedures, maintenance, and tire handling, see [Tires on page 7-3](#). Also see your Ram Promaster Owner's manual and review all tire care and tire safety information.

### **⚠ WARNING**

**Wheel fastener torque must be checked immediately after reinstalling a wheel and again after 25 miles. Torque all wheel fasteners evenly to specification using the proper sequence; see [Wheel Bolt/Lug Nut Tightening on page 7-8](#). For torque values, see [Specifications on page 4-3](#).**

## Tire Care Tips

To reduce the risk of tire failure:

- Check the pressure in your tires, including your spare (not provided with vehicle), at least monthly when the tires are cool (after the vehicle has been stopped for 3 hours and then driven less than 1 mi). Do not reduce pressure when tires are hot. Use a tire gauge to check pressure and maintain it at the proper level.
- Never overload your tires. Heed the maximum load-carrying capability of your tires.
- Never operate your vehicle in excess of lawful speeds, the maximum speeds justified by driving conditions, or in excess of speeds recommended for the tires you are using.
- Make every effort to avoid running over objects that may damage the tire through impact or cutting, such as chuck holes, glass, metal, etc.
- Never drive on smooth tires. Tires should be removed when 2/32 in. of tread depth remains. In most states, it is illegal to drive with less than 2/32 in. remaining tread depth.
- Park out of the sun whenever possible when in warm climates. In desert regions, use tire covers to prevent ultra violet light deterioration.

## Tire Inspection and Storage

Before taking your touring coach on a trip, inspect tires and wheel rims for any condition or damage that might result in tire failure. Inspect the front and back of sidewalls, tread area, valve stems, valve stem caps, and wheel rims for the following:

- Sidewalls for bulges, cracking, punctures, cuts, abrasions, and foreign objects (nails/screws).
- Tread for foreign objects, irregular/uneven wear, bulges, cracking, punctures, and cuts. An uneven wear pattern can indicate misalignment or worn suspension parts.
- Check that tread depth remains above at least 2/32 inch. Tread depth gauges are available at most automotive parts stores.
- Wheel rims for missing wheel weights, bead or flange damage from curb strikes, and overall general condition.

### **⚠ WARNING**

**Due to RISK OF EXPLOSION damaged tires or tires run with more than a 20% underinflation (approximate) must be dismantled, inspected by a trained professional, and should not be inflated without using a safety cage.**

Since many touring coaches see infrequent seasonal use, tires may take years to wear out. Tires will age and deteriorate over time so they may require replacement even if tread depth is optimal. Tires with any of the conditions listed above may require replacement. If you are unsure, consult a tire installer. Any tire with tread depth less than 2/32 inches deep should be replaced before your next trip.

Store your touring coach in a cool, dry area away from major heat sources and extreme cold. An enclosed storage area is best, with no exposure to electromagnetic sources such as generators or transformers. Cover your tires from direct sunlight if you must keep your touring coach outside. Take your touring coach to your tire dealer for service to check or correct any of these conditions.

## Plumbing

### Water System (Self-Contained)

The fresh water system consists of a city water hookup, fresh water tank gravity fill, fresh water tank and drain valve, water pump, hot and cold water lines, hydronic heating and hot water system, faucets, and an external sprayer port. Full explanations on the locations and use of these features are explained in this section. Also, see [Water Service Compartment on page 6-6](#).

Before using the water system, ensure the low point drain valve is closed; see [Component Locations for Winterization on page 9-10](#).

Fill the water tank by opening the right rear door to access the gravity water fill. For instructions on using the gravity water fill, see [Gravity Water Fill on page 6-6](#).

### NOTICE

**To prevent equipment damage, the hydronic water heater should only be started after the water system is primed and ready for use.**

### Water Pump and Strainer

The water pump and strainer are behind the large panel on the face of the curbside bed base. Turn the water pump on by pressing the Water Pump icon on the Multiplex home screen. Once turned on, the pump will run until the water pressure reaches approximately 50 psi. At this point, an internal pressure switch will shut it off. The water pressure will drop when opening the faucets, and the pump will start to run again.

As a general rule, the water pump should be off when connected to a city water source; however, the water pressure at some campgrounds may be low. To assist the city water hookup pressure, turn on the pump. To use the water pump while hooked to city water, you will need some water in the fresh water tank for the pump to function properly. The tank does not need to be full as the pump will only use what it needs to increase the pressure to 50 psi.

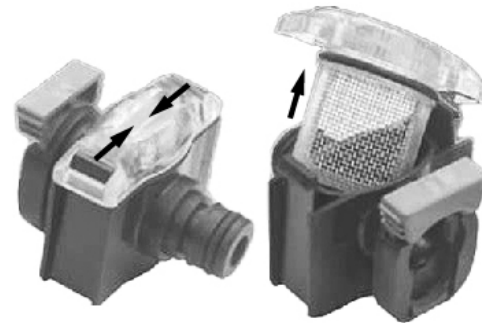
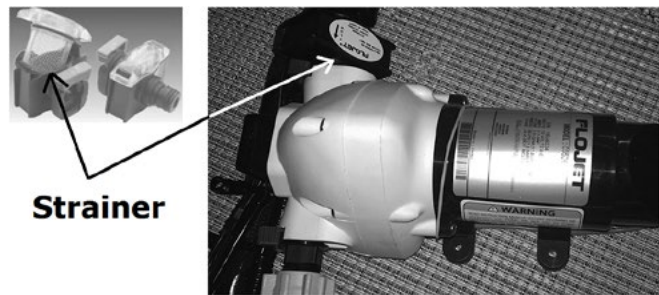

### Cleaning the Strainer

The strainer is mounted at the water pump inlet. Visually inspect it for accumulation of dirt/debris that could affect water flow and clean as needed:

1. Rotate the strainer housing to a position allowing access to the clear-view screen retainer and the tabs holding it in place.
2. Pinch the tabs inward to release the clear plastic retainer (as shown above).
3. Pull the retainer and screen out of the housing for cleaning. Rinse all debris from the screen.
4. Replace the screen assembly by aligning the screen in the seating grooves and pressing down gently until the tabs are back in place.

### Disconnecting the Strainer/Water Pump Lines

The inlet and outlet hoses and the strainer assembly are held in place by self-sealing, blue, quick-connect fittings:

1. Grasp the blue tab on the female fitting by the grooved finger edges and pull straight out on the tab to release the male fitting.
2. Be sure that both the female and male fittings on the disconnect are free of all debris and damage before replacing them.
3. Check the pump system for leaks when reinstalling the disconnect fittings.

**NOTICE**

**Failure to check the quick disconnect fitting for water leaks when reinstalling inlet and outlet hoses or the water pump strainer may cause the pump system to leak, causing damage to personal property.**

**NOTICE**

**Turn the water pump off when the touring coach is left unattended or in motion.**

**Sanitizing**

Potable water systems require periodic maintenance to deliver a consistent flow of fresh water. Airstream recommends sanitizing before and after storage, after new component installation, and if the system is contaminated. When determining how often to sanitize the system, consider environmental factors, usage, and the quality and taste of the water coming out of the system.

Decide whether you want to use an RV fresh water cleaner & deodorizer or a mixture of bleach and water. The following instructions are for the use of bleach. If using an RV fresh water cleaner and deodorizer, follow the instructions on the container for mixture and contact time, and use the instructions below to introduce the solution into the system.

Gather the following supplies ahead of time. These are available at most RV supply stores:

- RV fresh water cleaner & deodorizer; or bleach.
- Gallon-size container(s) or a clean bucket suitable for potable water.
- Container from which you can pour the sanitizing mixture into the gravity water fill or an RV antifreeze hand pump kit.

For the following procedures, you will need to know how many ounces of bleach to add to your bleach/water mixture. Use this formula:

Tank Capacity x .13 = Amount of Bleach Needed

To reduce the amount of time it takes to disinfect the tank from four hours to one hour, double the amount of bleach.

**Sanitizing the Fresh Water System**

1. Determine the amount of bleach you need for your tank capacity using the guidelines above; [see Specifications on page 4-3](#) for tank capacity.

2. Pour the bleach into a container and fill it with water to make a bleach/water concentrate.
3. Using the gravity water fill, pour/pump the concentrated bleach mixture into the fresh water tank and fill the tank with water; [see Gravity Water Fill on page 6-6](#). Monitor tank level on the Multiplex home screen.
4. OPEN all faucets (hot and cold).
5. Turn the water pump ON (Multiplex home screen) and run it until the mixture starts coming out of the faucets and the odor of chlorine is detected. Once the solution is running from the taps you can start closing them. Move from one fixture to the next, shutting them off as you go until all the lines are full.
6. Turn the pump OFF and leave the solution in the system for 4 hours of contact time to complete the disinfection process. Or, if doubling the bleach concentration, 1 hour.
7. Drain the tank, refill with fresh water, and run the faucets until the bleach/water solution is flushed from the system. For fresh water tank drain location, [see Component Locations for Winterization on page 9-10](#).

**NOTE**

**The sanitizing procedure outlined above is in conformance with the approved procedures of RVIA ANSI A 119.2 and the U.S. Public Health Service.**

## Drain and Waste System

Your touring coach has a drain and waste system that includes waste-holding tanks made from corrosion-free, molded plastic with trouble-free dump valves.

The black water holding tank enables you to use the toilet for several days away from disposal facilities. The wastewater from the lavy sink, shower, and galley drains into the gray water holding tank. Each tank has a dedicated dump valve with both tanks draining through a common outlet. Only one sewer hose connection is needed when hooking up to a dump station.

Check the tank levels on your multiplex screen regularly. The toilet bowl cannot be emptied if the black water tank is full. If the gray water tank is full, drain water will back up into the shower floor pan.

Draining the tanks as described in this section will protect them from freezing during storage. When traveling in sub-freezing temperatures, use a winterizing solution designed for RV use. Follow the directions on the container.

Never drain the tanks at any place other than an approved dumping station. Almost all campgrounds will have dumping facilities. Park directories, such as Woodalls and Rand McNally, also list dumping stations. Furthermore, the vehicle navigation system may be able to locate nearby dumping stations or have the capability to mark/save stations along your route.

### NOTICE

**Do not use a pipe snake on clogged drains as it could result in damage to internal components of the drain system.**

### NOTICE

**Never put wet strength paper towels or tissues in your holding tank since they will not dissolve and can catch in the mechanism of the dump valve. Colored toilet tissue is slower to dissolve than white. Most motorhome accessory stores offer tissue designed for RVs that will completely dissolve.**

## Black and Gray Water Tank Draining

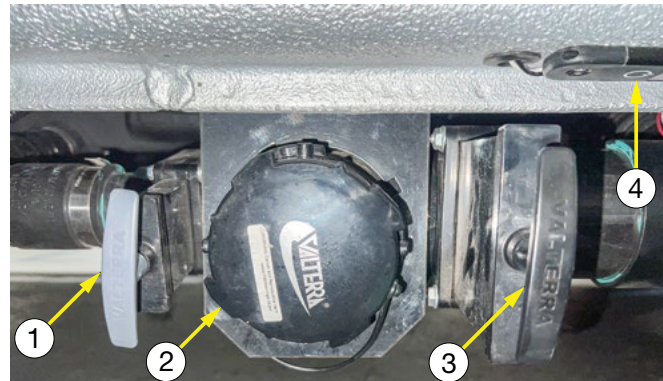

1. Gray Tank Valve
2. Drain Hose Hookup
3. Black Tank Valve
4. Courtesy Light

Dump the black tank before the gray tank. Doing so will help rinse the sewer line with gray tank water.

To empty one or both tanks:

1. Remove the sewer drain hose from the storage tube under the coach, below the right rear door, and remove the caps.
2. Attach the outlet adapter to the clear-view elbow outlet on the end of the drain hose.
3. Attach the hose to the coach's drain hose hookup by pressing the bayonet fitting onto the outlet. Rotate clockwise until it feels solid and secure.
4. Attach the outlet end (clear-view end) of the hose to the dump station's inlet, ensuring the hose is positioned to drain completely.
5. Pull the black plastic "T" handle to open the black tank dump valve, allow the tank to drain completely, and close the dump valve.
6. Use the black tank flush (located in the Water Service Compartment) to partially refill the tank with clean water and repeat the process until clean; [see Black Water Tank Flush on page 9-9](#) and [see Water Service Compartment on page 6-6](#).
7. Continue flushing the black tank to remove all paper and waste material, indicated by clear running water. Close the black tank valve.
8. Pull the gray plastic "T" handle to open the gray tank dump valve, allow the tank to drain completely, and close the dump valve.



### Black Water Tank Flush



The coach has a garden hose style connection to flush the black water holding tank; see [Water Service Compartment on page 6-6](#).

Airstream advises flushing the black water holding tank each time it is emptied to prevent clogging of the water jets and accumulation of waste solids inside the tank. Start by emptying the holding tanks at an approved dump station and close the dump valve. To flush the tank:

1. Attach a water hose to the flush inlet (do not use the fresh water tank hose for this purpose).
2. Turn the water on and monitor the black tank level. A sprayer head with multiple holes will spray the tank's interior surface. Fill the tank about half full and turn the water off.
3. Once the tank is about half full, turn the garden hose off and flush the water from the tank using the dump valve, as shown in the previous section. The black tank valve should be closed for the first couple of minutes and then opened to let the water out in a rush. Repeat as needed until the water runs clear.

#### **NOTICE**

**Use the black tank flush regularly to keep the holes on the spray head from becoming clogged.**

### Drain Systems Cleaning

The only cleaning agents that can be used without causing harm to the system are household ammonia and tri-sodium phosphate in small quantities. Do not use any product that contains any portion of petroleum distillates. This type of product will attack the rubber seals of your toilet and dump valve. Also, do not use any dish detergent or abrasive cleaners. All products should be marked as approved for ABS drainage systems.

## Winterizing and Storage

When storing your touring coach, use the same precautions you would in your home regarding perishables, ventilation, winterizing, and rain protection. In addition, for prolonged storage periods, flush out all the drain lines and waste holding tanks. Also, drain the entire water system, including the fresh water tank. Instructions for draining the water system are explained in the following paragraphs on winterizing.

The primary consideration in winterizing is to protect the fresh water lines, waste drain lines, waste holding tanks, hydronic heating and hot water system, and battery from freeze damage.

### NOTICE

**In very cold weather, winterizing the touring coach is recommended to prevent damage to the waste systems.**

### NOTICE

**Ram recommends disconnecting the negative battery cable from the Ram chassis battery for vehicle storage of more than 3 weeks.**

### NOTICE

**Ram recommends any time you store your vehicle or keep it out of service for two weeks or more, run the air conditioning system at idle for about five minutes in the fresh air and high blower setting prior to storing. This will ensure adequate system lubrication to minimize the possibility of compressor damage when the system is restarted.**

## Touring Coach Winterization

To perform these steps, you will need an adapter with an air regulator to connect an air compressor to the city water inlet, and access to an air compressor. Adapters are available at most RV stores.

### Component Locations for Winterization

Low Point Drain Valve - the fresh water system and fresh water tank are drained from a single valve. To access, remove the vent cover from the curbside bed base.

Water pump - behind the large access panel on the face of the curbside bed base.

Winterization Valve - behind the large access panel on the face of the curbside bed base.

Water Service Compartment - roadside exterior; [see Water Service Compartment on page 6-6.](#)

## Instructions for Winterization

1. Level the touring coach from side to side and front to rear, turn the water pump OFF, and disconnect the city water.
  2. OPEN all the hot and cold water faucets.
  3. OPEN the low-point drain valve and allow the system to drain; see component location this page.
  4. Attach the quick connect hose/sprayer nozzle to the sprayer port (water service compartment). Operate the nozzle to drain any remaining water and then disconnect the hose; [see Sprayer Port on page 6-6.](#)
  5. Allow all water to stop draining and proceed to the next step.
  6. For this step, you will need someone to operate the toilet foot pedal/flush valve. Using the air compressor, apply at MAX 50 PSI of air pressure at the city water inlet (water service compartment) until no water remains in the system. Operate the foot pedal on the toilet. You may need to depress the pedal a few times to work out all the water by allowing some air pressure to build up between flushing. Once all the water has been blown from the system, disconnect the air and continue to the next step.
- ### NOTICE
- Do NOT exceed MAX 50 PSI when clearing water from the system with compressed air. To much air pressure could damage the system.**
7. For this step, have a catch pan or a towel ready to place under the water pump outlet to prevent water from running out into the touring coach. Remove the quick-connect outlet fitting from the water pump; [see Disconnecting the Strainer/Water Pump Lines on page 9-6.](#)
  8. Turn the pump ON briefly to remove any remaining water from the pump head and lines running from the tank.
  9. Check the water pump strainer to be sure no water remains; [see Cleaning the Strainer on page 9-6.](#)
  10. RECONNECT the water pump if you plan to add RV antifreeze using the optional steps below. Otherwise, leave the fittings from the pump disconnected until the system is ready to be used again. Best practice: leave a note as a reminder near the multiplex screen that the water pump is disconnected.

11. Fully charge the battery; [see Battery Charging on page 5-19](#).
12. Turn OFF the battery disconnect switch; [see Battery Disconnect Switch on page 5-15](#).

### **Optional-Additional Steps for Winterization**

An additional step to winterization is to consider adding a non-toxic RV antifreeze (approved for drinking water systems) to the water lines using the winterize valve to draw RV antifreeze from a container into the water system, using the water pump.

Before beginning, read the RV antifreeze manufacturer's label for instructions specific to the antifreeze you plan to use. It may take a few gallons to fill the entire system so prepare accordingly. As you follow these steps, it will be helpful to have another person watching and operating the faucets, shower head and toilet valve.

1. RECONNECT all lines and CLOSE all drain valves.
2. Ensure the external sprayer port hose is disconnected.
3. OPEN the sink and shower drains if they are closed.
4. Ensure all the water faucets and shower heads, hot and cold, are OPEN.



5. SET the winterize valve selector to "winterize" by rotating it clockwise (normal flow position shown above); [see Component Locations for Winterization on page 9-10](#).
6. Uncoil the hose connected to the winterize valve and place it in the RV antifreeze container.
7. Turn the water pump ON and run it until antifreeze starts coming out of the faucets. Once antifreeze is running from the taps you can start closing them. Move from one fixture to the next, shutting them off as you go until all the lines are full. Turn the pump OFF as you empty and transition from one antifreeze container to the next.

8. Allow the antifreeze to flow down drains. Flush the toilet and allow antifreeze to flow down the toilet. If equipped, work the hand shower sprayer while holding it down in the shower until antifreeze is coming out. Dump any remaining small amounts of antifreeze down a drain.
9. Shut the water pump OFF once all the lines are full.
10. OPEN all the faucets and leave them open.

### **NOTICE**

**Remove all RV antifreeze spillage from all sinks, drain pans, and faucet parts after winterizing. Failure to do so could damage surface finishes. Do not use water to rinse antifreeze down the drain as it will dilute the antifreeze.**

11. Fully charge the battery; [see Battery Charging on page 5-19](#).
12. Turn OFF the battery disconnect switch; [see Battery Disconnect Switch on page 5-15](#).

### **Water Heater Winterizing**

If the touring coach is to be stored during winter months, the water lines must be drained to prevent damage from freezing. The water heater only holds a couple of cups of water in the heat exchanger, which is drained with the low point drain valves; [see Instructions for Winterization on page 9-10](#).

### **Restoring Service**

1. Close the low point drain valve, holding tank dump valve, and all faucets.
2. If disconnected, reconnect the water pump line.
3. Add water to the fresh water tank.
4. Turn the water pump ON.
5. Open and close faucet valves one at a time until water runs clear signaling the RV antifreeze is flushed out of the lines. Recheck water clarity at all faucets.
6. Turn OFF water pump.
7. Hook up city water, open faucet valves, and recheck water clarity.

# Maintenance

---

## Toilet

### **Maintenance**

Your touring coach has a Dometic 301 toilet. See the manufacturer's guide in your owner's packet for maintenance, cleaning, and troubleshooting information. You can also visit Dometic's website at <https://www.dometic.com> to obtain a copy.

Should your RV be equipped with an alternative to Dometic, refer to that manufacturer's website.

### **Cleaning**

For routine cleaning, Dometic recommends using Sealand toilet bowl cleaner. If this cleaner is unavailable, use a non-abrasive bathroom and toilet bowl cleaner. Follow label instructions. For stubborn stains, use rubbing alcohol (sparingly).

#### **NOTICE**

**Do not use highly concentrated or high acid content household cleaners. They may damage the rubber seals.**

### **Winterization**

The toilet is winterized using the procedures on the previous page; see [Instructions for Winterization on page 9-10](#).

#### **NOTICE**

**To avoid damage when using air pressure to blow water from the lines, make sure the toilet valve is in the open position.**

#### **NOTICE**

**If water is frozen in the toilet, do not attempt to flush until the ice thaws. Never use automotive type antifreeze.**

Electrical Diagrams

12-Volt Main Schematic

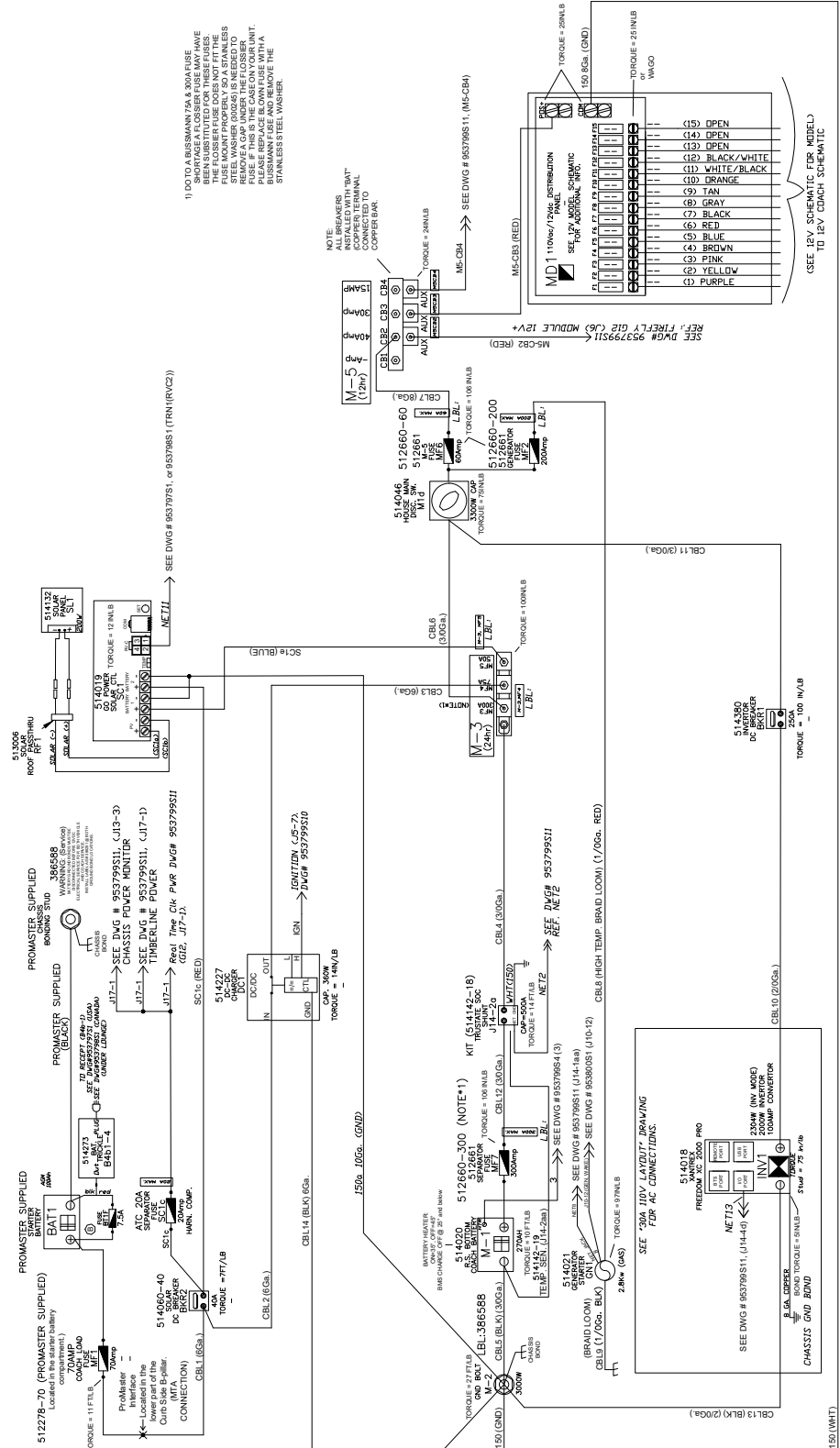

1) DO TO A BIGSMANN 77A & 300A FUSE SHORTCIRCUIT LOSSER FUSE MAY HAVE THE LOSSER FUSE DOES NOT FIT THE FUSE HOLDER. IF THIS IS THE CASE, REMOVE A GAP UNDER THE LOSSER FUSE AND REPLACE WITH A BRASSMAN FUSE AND REMOVE THE BRASSMAN FUSE AND REMOVE THE SHINLESS STEEL WASHER.

NOTE: BREAKERS INSTALLED WITH 'BAT' WIPERS MUST BE CONNECTED TO COPPER BAR.

MD 1 110V/12V AC DISTRIBUTION

SEE 12V WIRING SCHEMATIC FOR ADDITIONAL INFO.

1	PURPLE
2	PURPLE
3	PINK
4	BROWN
5	BLUE
6	RED
7	GRAY
8	GRAY
9	TAN
10	ORANGE
11	WHITE/BLACK
12	BLACK/WHITE
13	OPEN
14	OPEN
15	OPEN

(SEE 12V WIRING SCHEMATIC FOR WIREL TO 12V CATCH SCHEMATIC)

## 12-Volt Model Schematic

This document and the information contained within are confidential and proprietary to Airstream, Inc. and shall not be copied, distributed or used in whole or in part without express written consent.

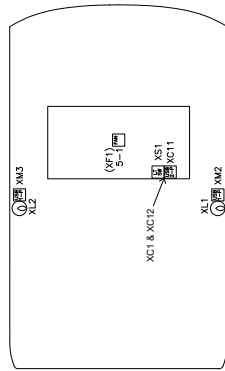

OPTION: POP TOP AREA

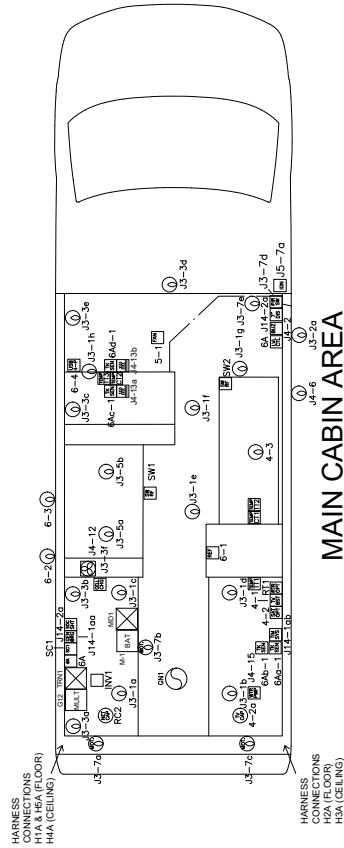

NOTE:  
 1) THIS LAYOUT SHOWS ALL 12VDC DEVICES. SOME DEVICE SYMBOLS ABOVE WILL NOT BE LISTED ON SHEET #2, BUT WILL APPEAR IN THEIR RESPECTIVE SCHEMATIC (VAN A/V OR 12V ELECTRICAL MAIN). FOR 110Vac SEE 304 110V LAYOUT DRAWING.  
 2) HIDDEN SCREEN-ENABLE BUTTONS AND NO PRE-WIRE TO DEVICES. (Hidden Firefly Program only)

GI2: See dwg# 953799S6, 953799S9, 953799S10, & 953799S11.

MDI: SEE AC DWG# 953797 (USA) OR 953798 (CANADA).  
 SEE DC DWG# 953799S4 & 953799S5

MTI: SEE DC DWG# 953800S1

TIMBERLINE: TEMP. SENSORS  
 (See Timberline information)  
 a) T1 (Zone 1 Temp.)  
 b) T2 (Zone 2 Temp.)  
 c) T3 (Ext. Temp.)

## 12-Volt Model Schematic

LABEL: 12VDC FUSE PANEL

PUR CIR.1	-A	OPEN
YEL CIR.2	-A	OPEN
BRN CIR.3	15A	READ/G LITS, FRT OVRD LT, CELL CHG, OPTIPOP-10P
BLU CIR.4	1A	GAL. LT (OPT NOT INCLUDED)
BLU CIR.5	7.5A	VENT
RED CIR.6	15A	CR., WTR LEVEL, DUMP/EXT LITS, 4P-USB
BLK CIR.7	-A	OPEN
TAN CIR.8	-A	OPEN
GRG CIR.9	-A	OPEN
GRG CIR.10	-A	OPEN
GRN CIR.11	-A	OPEN
LT GRN CIR.12	-A	OPEN

CIRCUIT LOAD CHART

CIRCUIT	CIRCUIT WATTS	CIRCUIT AMPS @ 12VDC	CIRCUIT FUSE (AMP)
PURPLE (1)	0	0	-
YELLOW (2)	0	0	-
BROWN (4)	115.8	9.65	15
BLUE (5)	115.8	9.65	15
RED (6)	60	5.0	7.5
BLACK (7)	109.5	9.04	15
TAN (8)	0	0	-
GRAY (9)	0	0	-
ORANGE (10)	0	0	-
WHITE/BLACK (11)	0	0	-
BLACK/WHITE (12)	0	0	-
18T (NO OPT.)			15 (NO OPT.)

SEE PREVIOUS SHEET

- (15) WHITE
- (14) OPEN
- (13) LT. BLUE
- (12) LT. GREEN
- (11) GREEN
- (10) ORANGE
- (9) TAN
- (8) GRAY
- (7) BLACK
- (6) RED
- (5) BLUE
- (4) BROWN
- (3) PINK
- (2) YELLOW
- (1) PURPLE

PUR (1) -Gr. - OPEN

YEL(2) -Gr. - OPEN

PUR (1)  
4.50W  
0.4A

YEL(2)  
0W  
0A

PNK (3)  
4.50W  
3.00A

PNK (3)  
7.5W  
6.0A

BRN(4)  
70.0W  
5.80A

BLU(5)  
0W  
0A

SEE DWGR #9298051  
REF: W-1 (4TR)

(SEE ROOF TV CAB)

(SEE A/V SCHEMATIC)

60W  
12VDC  
1.5A  
1.5A

514126 (OPT.)  
12VDC  
1.5A  
1.5A

12VDC  
1.5A  
1.5A

513793  
12VDC  
1.5A  
1.5A

513135  
12VDC  
1.5A  
1.5A

513135  
12VDC  
1.5A  
1.5A

1.6W  
LED

This document and the information contained within are confidential and proprietary to Airstream, Inc. and shall not be copied, distributed or used in whole or in part without express written consent.

CONTINUED ON  
NEXT SHEET

## 12-Volt Model Schematic

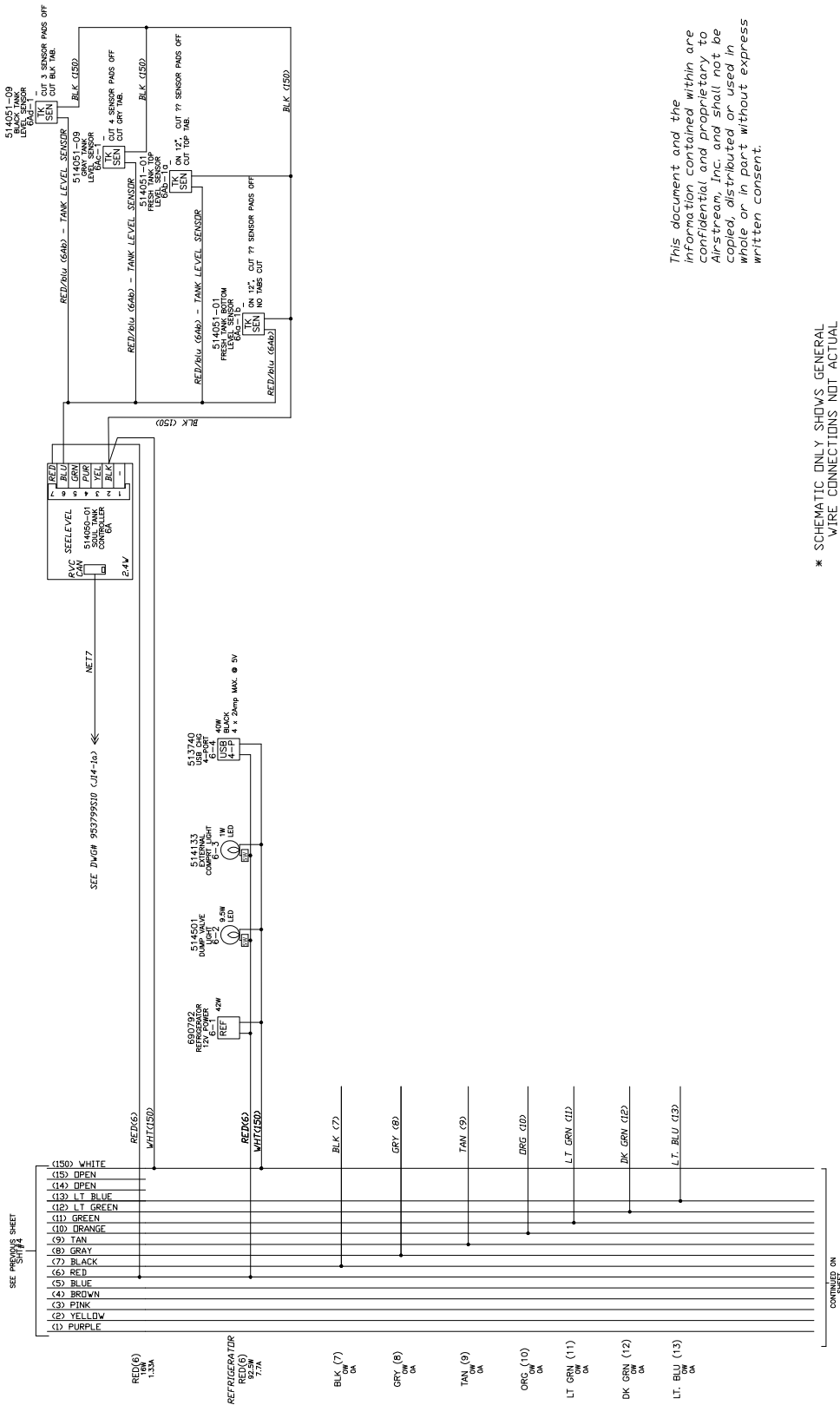

This document and the information contained within are confidential and proprietary to Air-Stream, Inc. and shall not be copied, distributed or used in whole or in part without express written consent.

\* SCHEMATIC ONLY SHOWS GENERAL WIRE CONNECTIONS. FOR ACTUAL WIRE ROUTING, SEE HARNESS DRAWINGS FOR ROUTING.



12-Volt Model Schematic

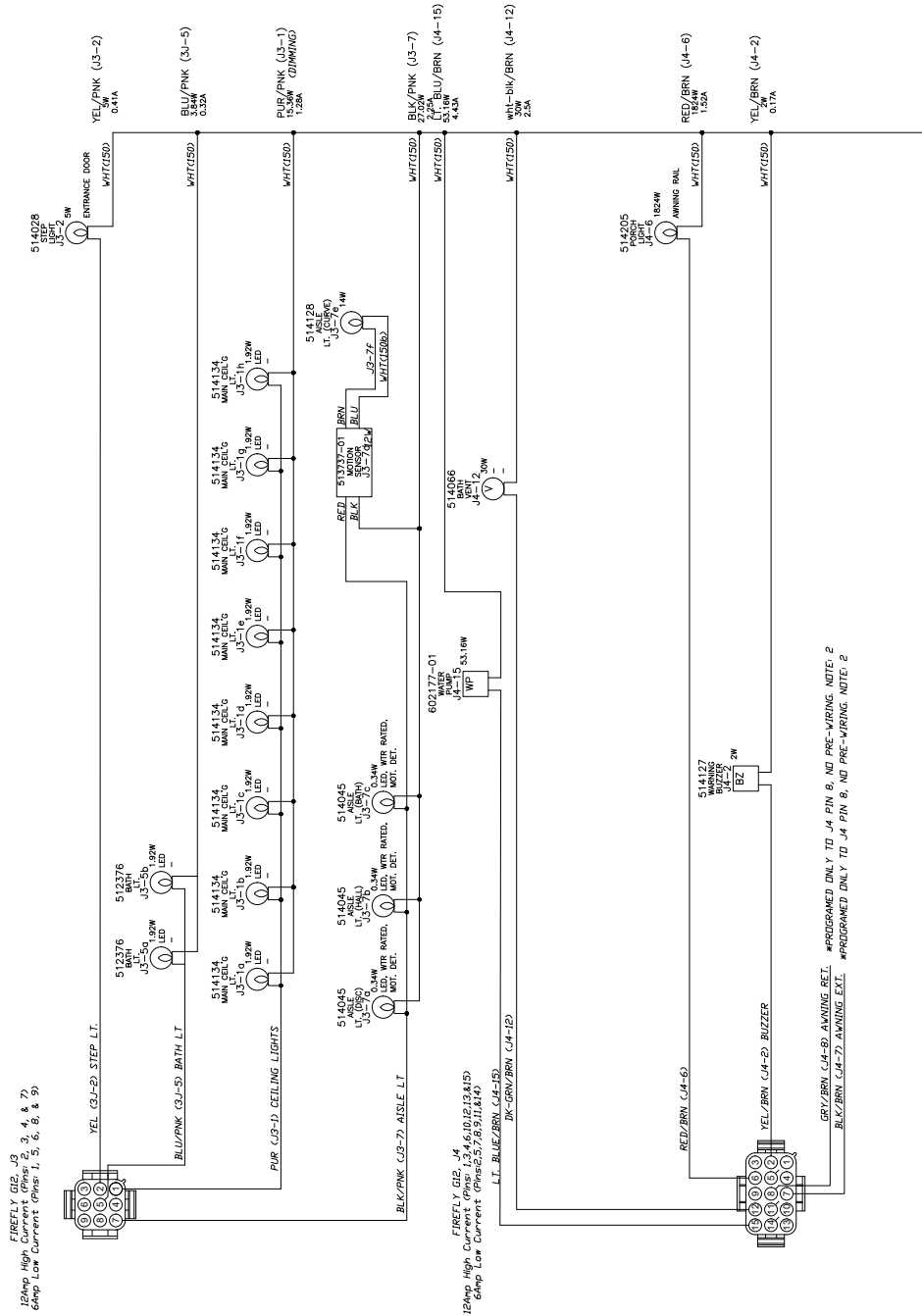

This document and the information contained within are confidential and proprietary to Airstream, Inc. and shall not be copied, distributed or used in whole or in part without express written consent.

\* SCHEMATIC ONLY SHOWS GENERAL WIRE CONNECTIONS NOT ACTUAL WIRE ROUTING. SEE HARNESS DRAWINGS FOR ROUTING.

#PROGRAMMED ONLY TO J4 PIN 8, NO PRE-WIRING NOTES 2  
#PROGRAMMED ONLY TO J4 PIN 6, NO PRE-WIRING NOTES 2

## 12-Volt Model Schematic

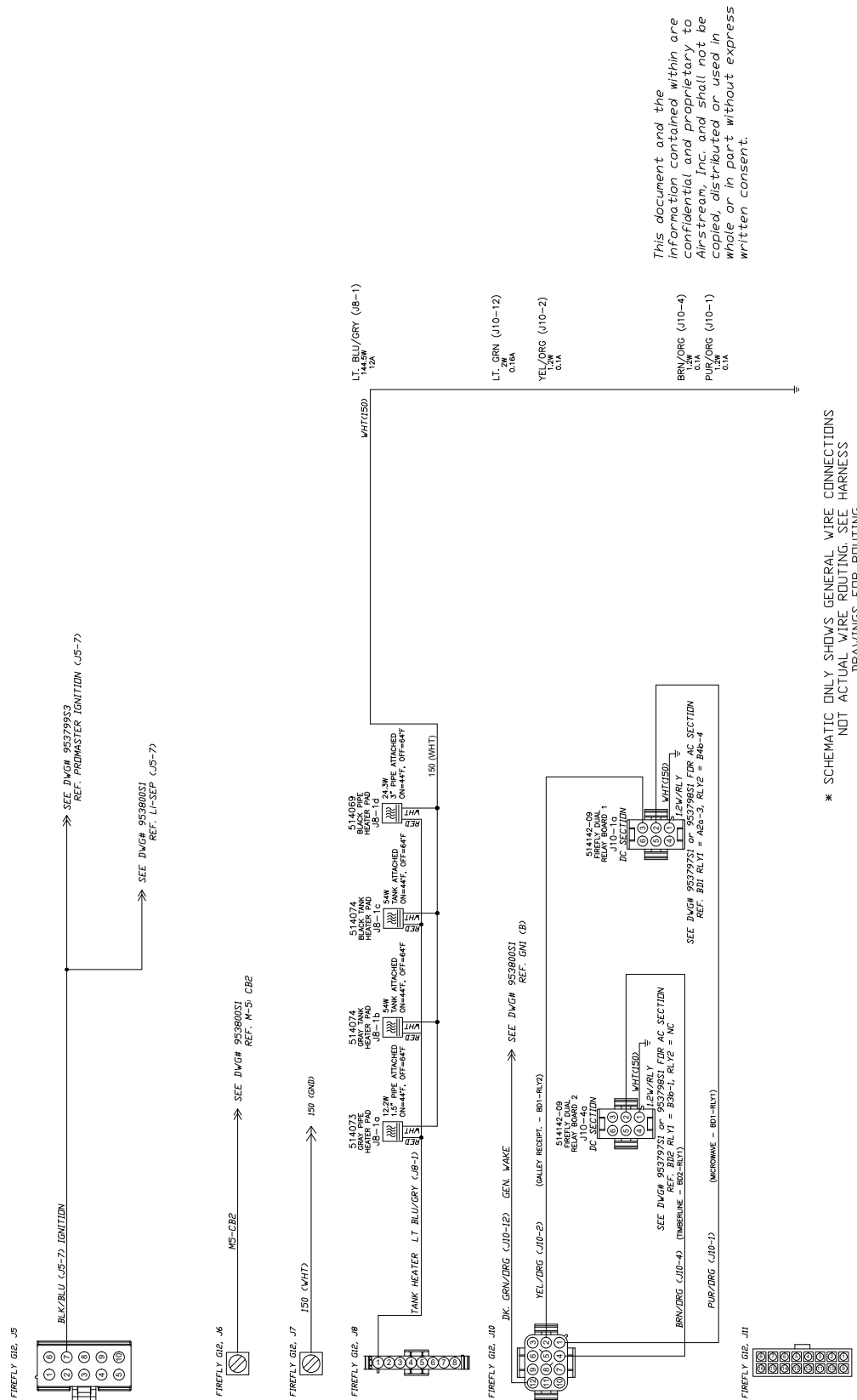

## 12-Volt Model Schematic

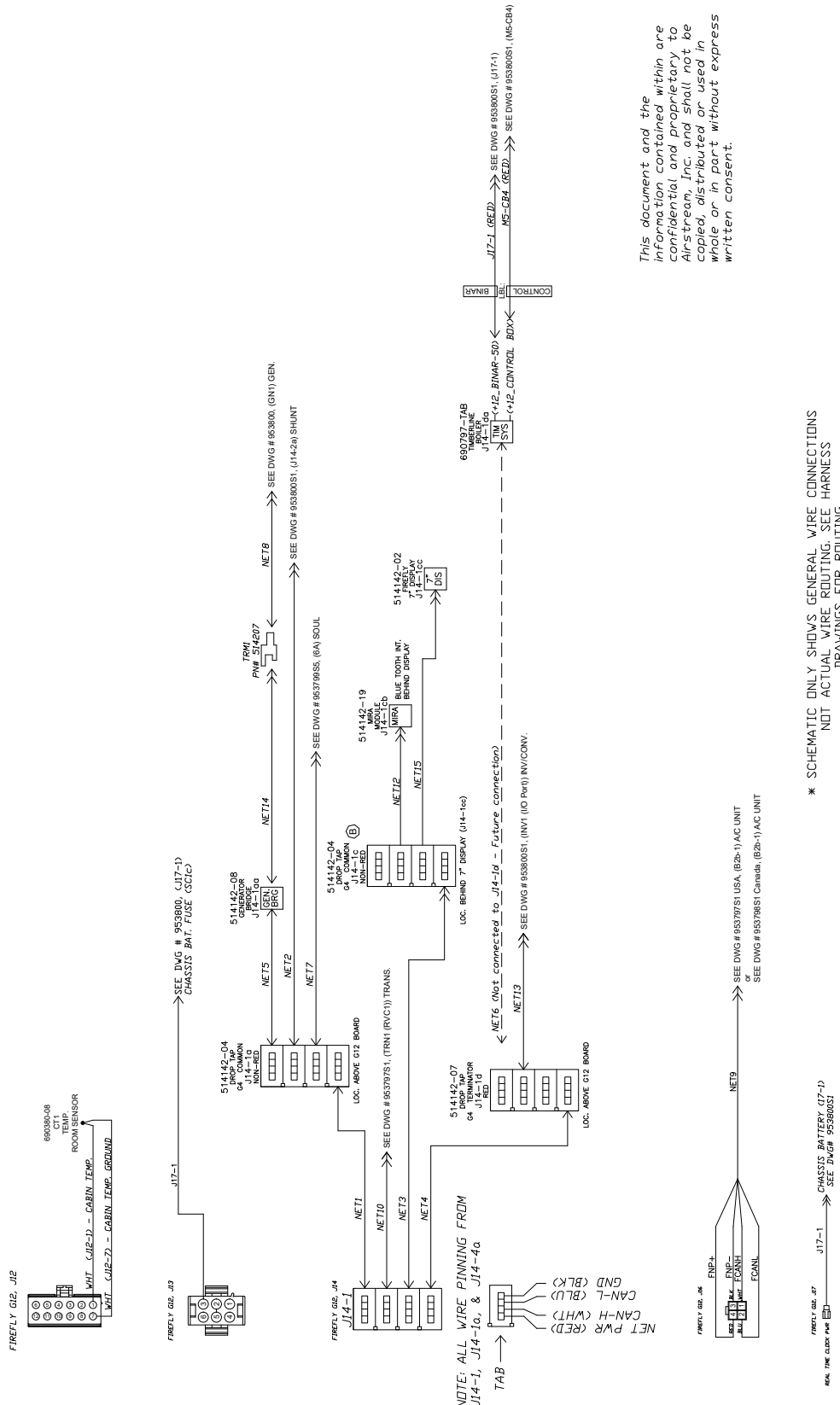

This document and the information contained within are confidential and proprietary to Alstream Inc. and shall not be copied, distributed or used in whole or in part without express written consent.

\* SCHEMATIC ONLY SHOWS GENERAL WIRE CONNECTIONS NOT ACTUAL WIRE ROUTING. SEE HARNESS DRAWINGS FOR ROUTING.

## 30-Amp 120-Volt Schematic

This document and the information contained within are confidential and proprietary to Air-Stream, Inc. and shall not be copied, distributed or used in whole or in part without express written consent.

- 1) DRAWING SHOWS ALL OPTIONS.
- 2) GFCI breaker must have load and locked, and must be in the breaker area for the GFCI position.
- 3) Inverter's output has two breakers located in the main breaker box. (This is a 30amp input breaker and a 20amp output breaker). Inverter breaker, which then feeds the inverter loads.

- 386434
- 514029
- 514033
- 514273
- 514273
- 51115-02
- 51115-01
- 51181-01
- 514273
- 514273
- 51115-02
- 51115-01
- 51181-01
- 514273
- 51115-02
- 51115-01
- 51181-01
- 514273
- 51115-02
- 51115-01
- 51181-01

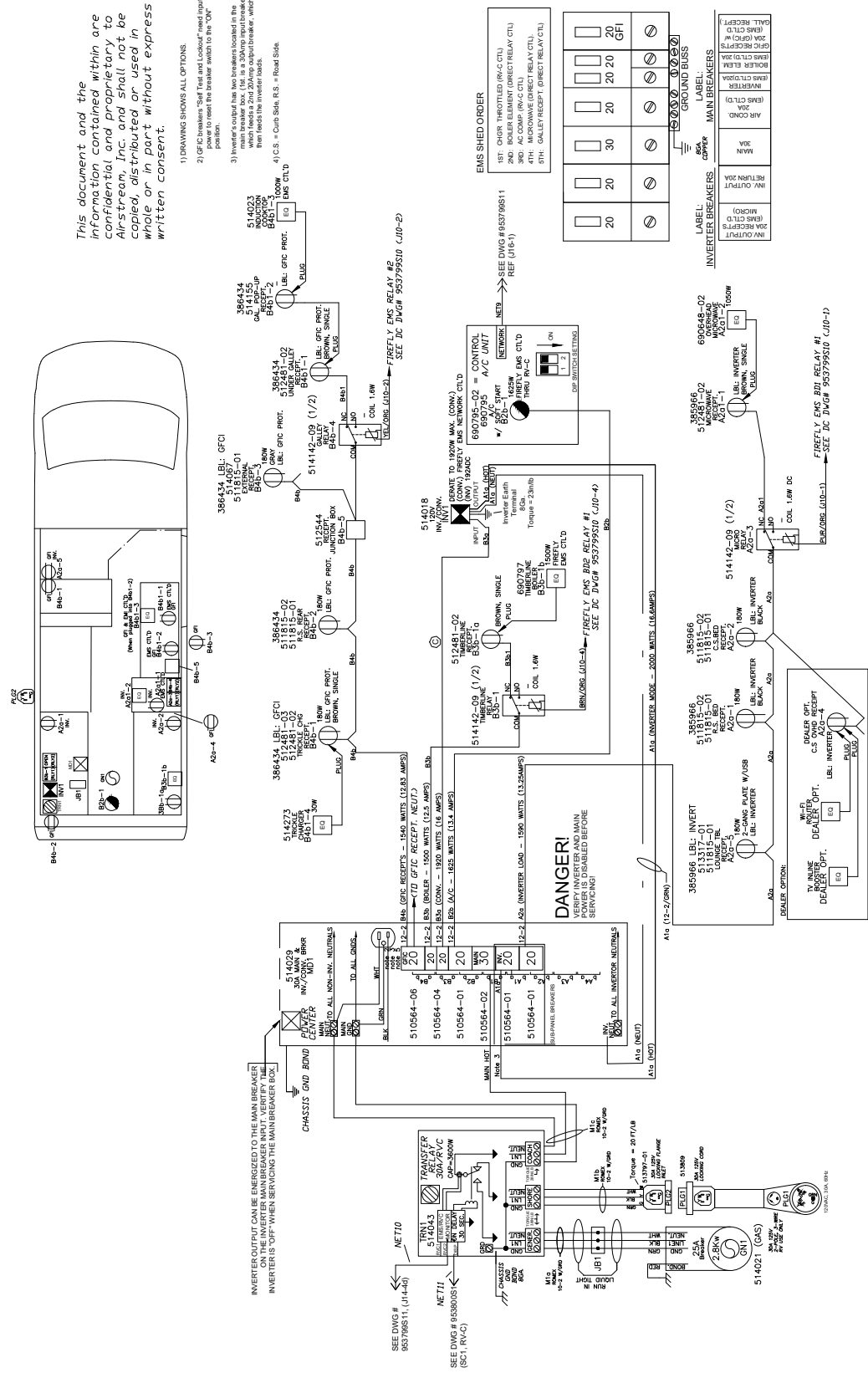

## Audio and Video Schematic

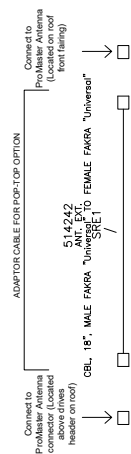
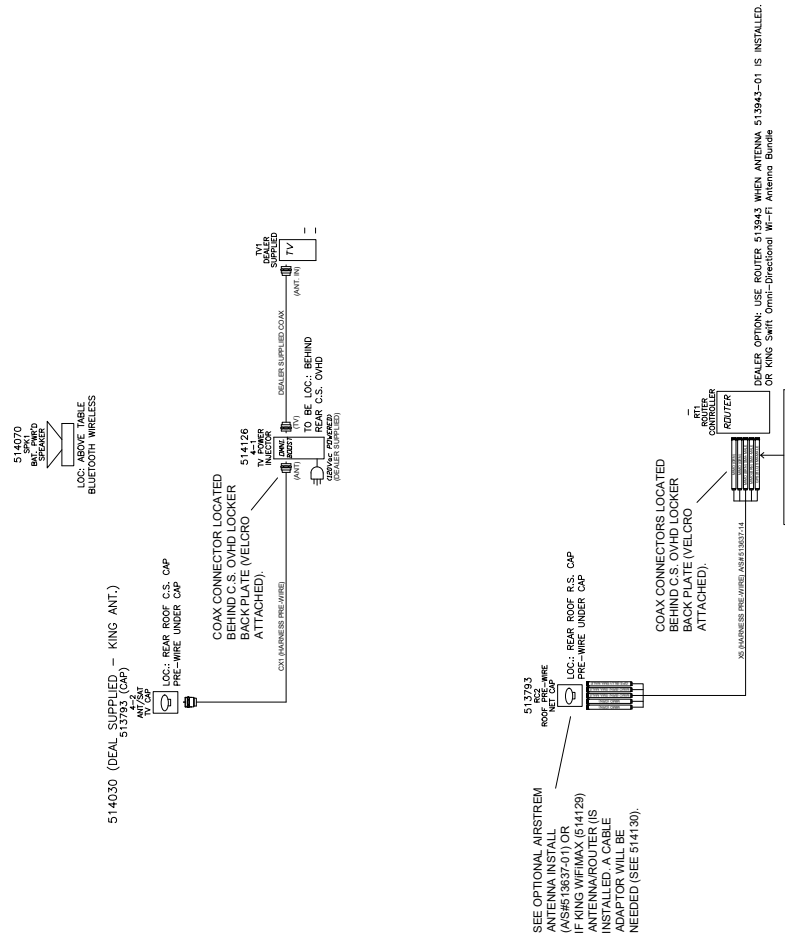

*This document and the information contained within are confidential and proprietary to Airstream, Inc. and shall not be copied, distributed or used in whole or in part without express written consent.*

## Fresh Water Layout

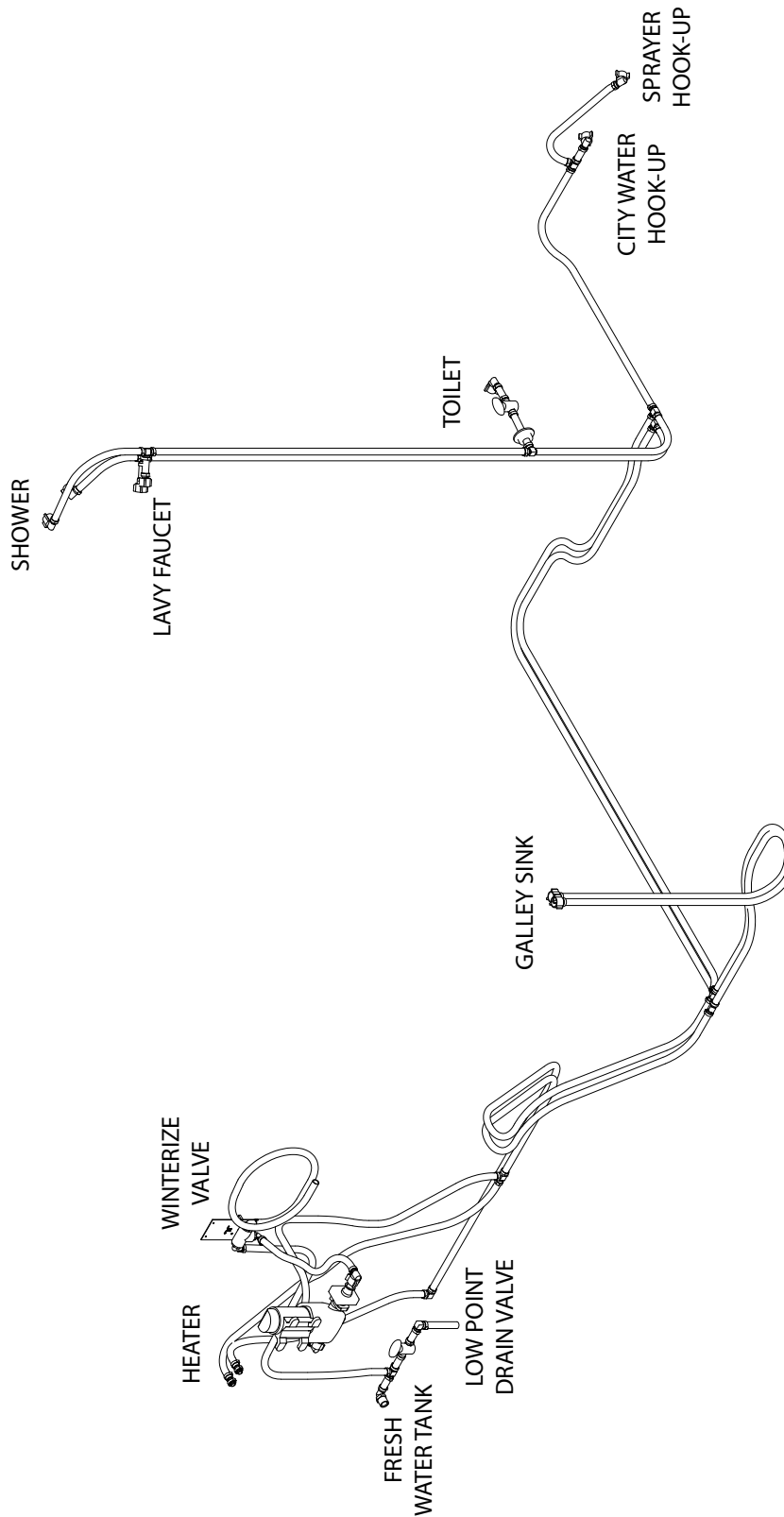

## FAQs and Answers

### Electrical

#### 1. *What should I do to maintain my generator?*

Answer: During the initial break in period, you will need to check your oil every 4 hours during the first 20 hours of operation. Once you reach 20 hours of operation, you will need to change the oil. (Refer to the Onan's Owner's manual for more information); [see Generator on page 5-17](#) and [see Maintenance Schedule on page 9-2](#).

#### 2. *My generator stalls out or quits running if I turn a corner.*

Answer: Make sure you check the oil level. There is a sensor built into the generator that will shut the engine down if it is too low. Turning the corner or stopping quickly while oil is low can cause this to happen; [see Generator on page 5-17](#).

#### 3. *What size battery do I have in my Airstream Rangeline?*

Answer: Your Airstream is factory equipped a Battle Born 270Ah 12V LiFePO4 Deep Cycle Gamechanger 3.0 House Battery; [see House Battery on page 5-15](#).

#### 4. *My generator will not run properly while I am showing I have ¼ tank of fuel; however, it runs fine when tank is showing ½ or more.*

Answer: This could be a demand issue. If you are using other appliances, the outside temperature is below 32°F, and the BTU output is lower than at 72°F, the generator will not run properly. This would cause the generator to stall out or run poorly by not creating the proper 120 volts of power; [see Generator on page 5-17](#).

#### 5. *What is the battery disconnect switch function?*

Answer: The switch is used to cut power when the Rangeline is not being used or put into storage to preserve battery charge. It disengages or engages the 12-volt power supply from the house battery; [see Battery Disconnect Switch on page 5-15](#).

#### 6. *Do you recommend using a surge protector when plugged into shore power?*

Answer: Your Airstream is breaker protected. However, with the use of more personal electronic devices and the number of motorhome users in parks, added protection is always a plus.

#### 7. *What is my inverter powering?*

Answer: The inverter provides power to the microwave. It also powers outlets on the inverter circuit (identified by the affixed "Inverter Circuit" label). The inverter/charger performs multiple functions; [see Inverter/Charger on page 5-17](#).

### Plumbing

#### 1. *Do I need a water regulator?*

Answer: No, your Airstream is equipped with a built-in regulator rated for 50 psi.

#### 2. *How do I get fresh water into my Rangeline?*

Answer: You can use the onboard fresh water tank and 12-volt pump for your water supply when camping in a remote area, or hook to an external water source via potable water hose to exterior water inlet when parked at a campground; [see Water Service Compartment on page 6-6](#).

#### 3. *What is the difference between a Gray Water tank and the Black Water tank?*

Answer: The Gray Water tank holds water from shower and sink drains. The Black Water tank holds sewer water from the toilet; [see Drain and Waste System on page 9-8](#).

#### 4. *How do I use my Black Water tank flush?*

Answer: First, empty your Black Water tank, and then close your Black Water tank valve. Hook up your hose to the external hookup, run water through for a couple minutes, and then open the valve. Do this a couple times until the tank is clear; [see Black Water Tank Flush on page 9-9](#).

#### 5. *My Gray Water valve will not open while I have the Black Water valve open.*

Answer: True, you can only have one valve open at a time.

### Audio-Video

#### 1. *Can I install a TV and antenna; what about Wi-Fi?*

Answer: Yes, your coach is pre-wired for installation; [see TV and Antenna Prewire on page 5-23](#).

# Maintenance

---

## Chassis

### 1. *Where is my spare tire located?*

Answer: A spare tire is not supplied with the touring coach.

### 2. *How do I jack the touring coach up to change a tire?*

Answer: Please refer to the Ram owner's manual.

### 3. *Where can I find my touring coach's serial number?*

Answer: A label is attached on the driver's side B-pillar or the passenger's door. This label will also provide the inflation pressure of the tires and weight specifications.

## Appliances

### 1. *I am planning for a trip in my Airstream. How should I get the refrigerator cooled down?*

Answer: Turn the battery disconnect switch ON and set the refrigerator thermostat between 3 and 4. It may take several hours to completely cool the refrigerator. Also consider that every time the door is opened, it may take an hour to recoup the lost air.; [see Refrigerator on page 5-27](#).

### 2. *My air conditioner freezes up. What is the problem?*

Answer: In high humidity conditions, the AC manufacturer recommends you operate your AC (manual mode) on the high fan setting and all vents should be open to have maximum air flow over the coils; this helps reduce icing. Also, dirty AC filters can restrict air flow and cause the AC to ice up; [see Air Conditioner on page 5-24](#).

## Maintenance

### 1. *Can I have my awning out with heavy winds?*

Answer: No this may cause damage if it is too windy; [see Awning on page 6-8](#).

### 2. *I want to clean the exterior of my Airstream. What do you suggest?*

Answer: Airstream recommends washing based on operating conditions, and waxing a minimum of twice a year. Any automotive wax designed specifically for clear coated surfaces will provides good wax protection; [see How to Care for Your Touring Coach Finish on page 6-2](#).



## Index

### A

AGS 5-18  
 Air Conditioner 5-24  
 Airstream Academy ii  
 Alarms 2-4  
     Carbon Monoxide Alarm 2-4  
     Smoke Alarm 2-4  
 Alternator 5-20  
 Appliances 5-24  
 Automatic Generator Start 5-18  
 Awning 6-5, 6-8, 6-9, 7-3

### B

Bath 5-4  
 Battery 5-15  
     Battery Disconnect 5-15  
     Charging 5-19  
 Battery Disconnect Switch 5-15  
 Battery Management System (BMS) 5-16  
 Bed 5-8  
     Bed Access Step 5-8  
 Bench Seat 5-7  
 Black Tank Flush 3-10, 6-7  
 Black Water Tank 9-9  
 Bluetooth App 5-22  
 Bluetooth Speaker 5-23

### C

Camping 3-7  
     Extended Stay 3-8  
 Carbon Monoxide 2-6  
     Symptoms of Carbon Monoxide Poisoning 2-6  
 Carbon Monoxide Alarm 2-4  
 Cargo Storage 5-6  
 Ceiling Vent Fan 5-25  
 Charger 5-17  
 Check List 3-7, 8-10  
 Child Safety Seat 8-4  
 Circuit breakers 5-12  
     GFCI breakers 5-12  
 City Power 5-13  
 City Water Hookup 6-7  
 Cleaning 5-3  
 Coach-Net 3-6  
 Cooktop 5-24  
 Cordset 6-7

### D

Doormat and Rug Selection 5-4  
 Drain and Waste System 9-8  
 Drain System 3-10  
 Drain Valve 9-10

### E

Electrical Diagrams 9-13  
 Electrical System 5-11  
     Electrical System Operation 5-15  
 Emergency Exit 2-8  
 EMS 5-14  
 Energy Management System 5-14  
 Exhaust Vent 5-25  
 Exterior Care 6-2

### F

Fan 5-25  
 FAQs 9-23  
 Faucets 5-5  
 Fire Extinguisher 2-7  
 Fresh Water Layout 9-22

### G

Generator 2-2, 2-7, 3-8, 4-3, 5-17, 5-18, 5-19, 5-20, 7-3, 9-2  
     Automatic Generator Start System 5-17  
     Safety 2-7  
 GFCI 5-12  
 Gravity Water Fill 6-6  
 Gray Tank 9-8  
 Gross Axle Weight Rating (GAWR) 4-4  
 Gross Combined Vehicle Weight Rating (GCWR) 4-4  
 Gross Vehicular Weight Rating (GVWR) 4-4

### H

Heated Tanks 3-11  
 Heater 5-26  
 Hydronic Heating and Hot Water System 5-26  
     Safety Information 2-7  
 Hydronic System 2-2, 2-7, 9-2

### I

Inverter 5-17  
 Inverter/Charger 5-17

### J

Jack 7-7

### L

Labels 4-4  
 LATCH Equipped Seat 8-5  
 LATCH system 5-7, 8-4  
 Lavy 5-5  
 Lighting 5-22  
 Loading 8-2  
 L-Track 5-6  
 Lug Nut Tightening 7-8

### M

Maintenance Schedule 9-2  
 Manufacturer's Certification Label 4-4  
 Microwave 5-27  
 Mira 5-22  
 Mold 2-2  
 Molle Panels 5-6  
 Multiplex System 5-20  
     Bluetooth App 5-22  
     Cleaning the Multiplex Touchscreens 5-22  
     Remote Controls 5-22

### O

Occupant and Cargo Carrying Capacity Label 4-4  
 Outlets 2-2, 5-13

### P

Parts 9-3  
 Pet Amenities 5-9  
 Phone Charger 5-23  
 Plumbing 9-6  
 Pop Top 5-9  
 Power Center 5-11

### R

Ram ProMaster Van 7-2  
 Refrigerator 5-27  
 Remote Controls 5-22  
 Roadside Assistance 3-6  
 Rug Selection 5-4

# Index

---

## S

Safety 2-2  
Safety Check List 8-10  
Sanitizing 9-7  
Screen Doors 6-9  
Seatbelts 8-4  
Seats 5-7  
Service 3-6  
Shoreline Connection 5-19  
Shoreline power 5-13  
Shoreline Power Inlet 6-7  
Sink 5-5  
SmartPlug 3-8, 5-13, 5-19, 6-4  
SmartPlug Cordset 6-7  
SmartPlug Inlet 6-7  
Smoke Alarm 2-4  
Specifications 4-3  
    Specification Tags 4-4  
Sprayer Port 6-6  
State of Charge 5-14, 5-18, 5-19,  
    5-20  
Storage 5-6  
Strainer 9-6  
Swivel seat 5-7

## T

Table 5-11  
Tank Draining 9-8  
Tank Flush 9-9  
Temperature Limits 5-16  
Tire and Loading Placard 4-4  
Tire Care  
    Inflation Pressure 4-3  
    Tire Size 4-3  
Tires 7-3  
    Changing a Tire 7-6  
    Overloading 7-4  
    Tire Care 9-5  
    Tire Inflation 7-4  
    Tire Rotation 7-9  
Toilet 3-10, 5-5, 9-12  
Torque Value 4-3  
Towing 8-5  
Trailer Towing 8-5

## U

Unloaded Vehicle Weight (UVW)  
    4-4  
User Guide Videos ii

## V

Vehicle Placard 7-3  
Vent Fan 5-25  
Videos ii

## W

Warranty 3-2  
Washing 6-2  
Waste System 9-8  
Waste Water System 3-10  
Water Fill 6-6  
Water Heater 5-26  
Water Pump 9-6  
Water Service Compartment 6-6  
Water System 3-10, 4-3, 5-14,  
    5-26, 5-27, 9-6, 9-7  
Waxing 6-3  
Weighing 8-2, 8-3  
Wheel Bolt/Lug Nut Tightening 7-8  
Windows 6-6  
    Window Coverings 5-4  
Winterization Valve 9-10  
Winterizing and Storage 9-10



# **AIRSTREAM<sup>®</sup>**

1001 West Pike Street

P.O. Box 629

Jackson Center, OH. 45334-0629

Phone: (937) 596-6111 Fax: (937) 596-7939

[www.airstream.com](http://www.airstream.com)